



---

# Device Management

SL1 version 10.1.0, Rev. 2

---

# Table of Contents

<b>Introduction</b>	<b>8</b>
What is a Device?	9
What is a Device Record?	9
What is a Device Class?	10
What is a Device Category?	10
How Does SL1 Manage Devices?	11
What is Discovery?	12
What is a Credential?	12
What is a Virtual Device?	13
What are Component Devices?	14
What is a Dynamic Application?	14
What is an SL1 Agent?	15
What is Virtualization?	15
What is an Asset Record?	15
<b>Using the Devices Page</b>	<b>17</b>
Viewing Devices	17
Viewing Additional Data about a Device	19
Aligning a Device with a Different Organization	20
Adding Devices with Discovery	20
Assigning Icons to Devices	20
<b>Using the Device Investigator</b>	<b>23</b>
Using the Device Investigator	24
Using the Info Drop-Down on the Device Investigator Page	28
Running a Device Report	29
Using Device Tools in the Activity Center	29
Overview of the Device Investigator Tabs	31
The Investigator Tab	31
Adding and Removing Metrics on the Investigator Tab	32
Editing the Metric Panel Order on the Investigator Tab	33
Combining Charts on the Investigator Tab	35
The Settings Tab	36
The Attributes Tab	40
The Collections Tab	40
The Configs Tab	41
The Events Tab	41
The Interfaces Tab	44
The Journals Tab	44
The Machine Learning Tab	45
The Map Tab	46
The Monitors Tab	46
The Notes Tab	47
The Ports Tab	48
The Processes Tab	49
The Redirects Tab	49
The Relationships Tab	50
The Schedules Tab	51
The Services Tab	52
The Software Tab	53
The Thresholds Tab	53
The Tickets Tab	54

<b>Using the Device Manager Page</b> .....	<b>56</b>
Viewing the List of All Devices .....	57
Device Manager Preferences .....	60
Filtering the List of Devices .....	60
Special Characters .....	62
Using the Advanced Filter with the List of Devices .....	65
Generating a Report for Multiple Devices .....	67
Generating a Report for a Single Device .....	69
Viewing the List of Component Devices .....	71
Availability for Component Devices .....	74
Viewing Children Devices .....	75
Filtering the List of Component Devices .....	75
Using the Advanced Filter with the List of Component Devices .....	76
Bulk Actions in the Device Management Page .....	78
Bulk Actions for Component Devices .....	79
Bulk Merging and Unmerging of Devices .....	81
Performing a Bulk Device Merge .....	82
Performing a Bulk Device Unmerge .....	84
<b>Managing a Single Device with the Device Administration Panel</b> .....	<b>87</b>
What is the Device Administration Panel? .....	88
Actions Menu .....	90
Device Properties .....	94
Viewing Read-Only Information About the Device .....	95
Editing Device Settings .....	96
Identification .....	97
Monitoring & Management .....	97
Preferences .....	101
Adding an IP Address to a Device .....	102
Removing an IP Address from a Device .....	104
Managing Device IPs .....	105
Clearing the Device Cache .....	108
Aligning a Secondary Credential .....	109
Adding the Device to a Device Group .....	112
Creating a Ticket About the Device .....	114
Adding a Note to a Device .....	116
Aligning Custom Attributes with a Device .....	119
Creating a New Extended Custom Attribute .....	120
Deleting an Extended Custom Attribute from a Device .....	122
Associating a Product SKU with the Device .....	123
Merging Devices .....	124
Merging Individual Devices .....	125
Unmerging Individual Devices .....	127
Performing Administrative Tasks for One or More Devices .....	129
Shortcut Keys for Device Administration panel .....	130
<b>Device Toolbox</b> .....	<b>132</b>
What is the Device Toolbox? .....	132
Accessing the Device Toolbox page .....	132
Viewing the Session Logs .....	135
<b>Managing Device Classes and Device Categories</b> .....	<b>137</b>
Device Classes .....	138
Generic   SNMP Device Class .....	139
Non-SNMP Device Classes .....	139

Component Device Classes .....	139
Agent-Only Device Classes .....	140
Legacy ICMP Device Classes .....	140
Viewing the List of Device Classes .....	141
Viewing the List of Device Classes in the Classic SL1 User Interface .....	141
Filtering the List of Device Classes .....	143
Special Characters .....	145
Creating Device Classes .....	147
Creating a New Device Class of Type "SNMP-Enabled" .....	148
Editing an SNMP-Enabled Device Class .....	151
Creating a New Device Class for a Device with Device Class "Generic   SNMP" .....	151
Creating a New Device Class for Devices That Do Not Support SNMP .....	155
Applying the New Device Class .....	160
Maintaining the New Device Class During Auto-Discovery .....	161
Editing a Device Class That is Not SNMP-Enabled .....	161
Creating a New Component Device Class .....	162
Editing a Component Device Class .....	163
Managing Device Classes .....	163
Manually Assigning a Device Class to a Device .....	164
Changing the Icon for a Device Class .....	164
Managing Device Classes in the Classic SL1 User Interface .....	166
Manually Changing the Device Class for a Device in the Classic SL1 User Interface .....	166
Changing the Icon for a Device Class in the Classic SL1 User Interface .....	168
Aligning One or More Device Classes with a Device Dashboard .....	169
Deleting One or More Device Classes .....	169
Device Categories .....	170
"Pingable" Device Category .....	170
Viewing the List of Device Categories .....	171
Creating a New Device Category .....	172
Editing a Device Category .....	172
Duplicating a Device Category .....	173
Assigning an Icon to a Device Category .....	173
Managing Device Categories in the Classic SL1 User Interface .....	174
Viewing the List of Device Categories in the Classic SL1 User Interface .....	175
Creating a New Device Category in the Classic SL1 User Interface .....	175
Editing a Device Category in the Classic SL1 User Interface .....	177
Deleting a Device Category .....	177
Aligning One or More Device Categories with a Device Dashboard .....	178
<b>Device Relationships .....</b>	<b>179</b>
What are Device Relationships? .....	180
Viewing the List of Device Relationships .....	181
Filtering the List of Device Relationships .....	183
Viewing Relationships for a Single Device .....	184
Viewing Device Topology Maps .....	185
Viewing Device Topology Maps in the Classic SL1 User Interface .....	187
Defining Device Relationships .....	188
Device Categories that Don't Support Parent-Child Devices .....	189
Event Correlation .....	190
Events that May Not Be Displayed in the Events Page .....	190
Defining Event Correlation .....	191
Layer-2 Topology Collection .....	194
CDP Topology Collection .....	194

LLDP Topology Collection .....	196
Layer-3 Topology Collection .....	198
<b>Device Maintenance .....</b>	<b>200</b>
What is Scheduled Maintenance? .....	201
What is User Maintenance? .....	202
The Maintenance Minimum Severity Setting .....	202
Enabling and Disabling User Maintenance for a Single Device .....	202
Enabling and Disabling User Maintenance for One or More Devices .....	205
Scheduling Maintenance for a Single Device .....	206
Viewing the Schedule Manager .....	206
Defining a Scheduled or Recurring Device Maintenance Window for a Single Device .....	207
Scheduling Maintenance for One or More Devices .....	210
Enabling or Disabling Scheduled Maintenance for One or More Devices .....	211
Deleting Scheduled Maintenance for One or More Devices .....	212
<b>Managing Dynamic Applications .....</b>	<b>213</b>
Viewing the List of All Dynamic Applications in SL1 .....	214
Searching and Filtering the List of Dynamic Applications .....	218
Special Characters .....	220
Managing the Dynamic Applications Aligned to a Device .....	223
Viewing the List of Dynamic Applications Aligned to a Device .....	224
Viewing Information about a Dynamic Application Aligned to a Device .....	225
Changing the Credential for a Dynamic Application Aligned to a Device .....	226
Updating the Poll Frequency for a Dynamic Application Aligned to a Device .....	226
Manually Aligning a Dynamic Application to a Device .....	227
Viewing the Status of a Dynamic Application Aligned to a Device .....	228
Understanding the Found Status .....	228
Understanding the Collecting Status .....	229
Enabling and Disabling Dynamic Application Data Collection for a Device .....	229
Enabling and Disabling Collection for Specific Collection Objects .....	229
Running a Dynamic Application on a Device .....	230
Managing the Dynamic Applications Associated with a Device in the Classic SL1 User Interface .....	230
Viewing the Dynamic Applications Associated with a Device in the Classic SL1 User Interface .....	230
Manually Associating a Dynamic Application with a Device in the Classic SL1 User Interface .....	232
Editing the Credential Associated with a Dynamic Application in the Classic SL1 User Interface .....	234
Viewing the Status of a Dynamic Application Associated with a Device in the Classic SL1 User Interface .....	235
Found .....	236
Collect .....	236
Performing Other Administrative Tasks for an Aligned Dynamic Application in the Classic SL1 User Interface .....	237
Enabling or Disabling Objects .....	237
Restarting Automatic Maintenance of Collection Objects .....	238
Editing the Poll Frequency for a Dynamic Application on the Current Device .....	238
Stopping Data Collection for a Dynamic Application .....	239
Resetting Statistical Data for a Dynamic Application .....	239
Resetting Persistent Session Objects for a Dynamic Application .....	240
Testing Data Collection for a Dynamic Application .....	241
Removing Data Collected by a Dynamic Application .....	241
How SL1 Manages the Collection Status for Dynamic Applications .....	242
Stopping Collection .....	242
Starting Collection .....	243
Collection Objects that are Excluded from Maintenance .....	243
Status of Objects for Deviation .....	243

Bulk Un-Aligning Dynamic Applications .....	244
Setting Thresholds for Dynamic Applications .....	245
Dynamic Applications and Discovery .....	246
How Does SL1 Align Dynamic Applications During Discovery? .....	246
Queuing Discovery from the Dynamic Applications Manager Page .....	247
<b>Device Thresholds and Data Retention .....</b>	<b>249</b>
Global Settings for Thresholds .....	250
Device Thresholds .....	255
Defining Device Thresholds in the Classic SL1 User Interface .....	261
<b>Bulk Management with Device Groups and Device Templates .....</b>	<b>264</b>
What is a Device Group? .....	264
What is a Device Template? .....	266
<b>Virtual Devices .....</b>	<b>269</b>
What is a Virtual Device? .....	269
Defining a Virtual Device .....	270
Directing Data to a Virtual Device .....	271
Redirecting Log Data to a Virtual Device .....	272
Aligning a Dynamic Application with a Virtual Device .....	274
<b>Customizing the User Interface for a Device .....</b>	<b>276</b>
Custom Navigation .....	276
Editing a Custom Navigation tab .....	278
<b>Vanishing &amp; Purging Devices .....</b>	<b>281</b>
Setting Vanish and Purge Thresholds .....	282
Viewing the List of Vanished Devices .....	283
Filtering the List of Devices .....	285
Using the Advanced Filters .....	286
Unmerging Vanished Devices .....	288
Manually Purging Selected Devices .....	289
Setting One or More Devices to Never Purge .....	290
<b>Device Dashboards .....</b>	<b>292</b>
Viewing the List of Device Dashboards .....	293
Creating a Device Dashboard .....	295
Aligning Device Dashboards .....	296
Aligning a Device Dashboard with a Device .....	296
Aligning a Device Dashboard with a Device Class .....	297
Aligning a Device Dashboard with a Device Category .....	298
Aligning a Device Dashboard with a Dynamic Application .....	299
Editing a Device Dashboard .....	300
Deleting a Device Dashboard .....	300
Copying a Device Dashboard .....	301
Defining the Global Default for Device Dashboards .....	301
Unaligning a Device Dashboard .....	303
Moving Alignment for Device Dashboards .....	304
<b>Using Custom Attributes .....</b>	<b>306</b>
Custom Attributes .....	307
Viewing the List of Custom Attributes .....	307
Filtering the List of Custom Attributes .....	310
Viewing the List of Subscribers for a Custom Attribute .....	310
Creating Custom Attributes .....	312
Deleting One or More Custom Attributes .....	313
Adding Custom Attributes for a Device .....	313
Adding Custom Attributes for a Device in the Classic SL1 User Interface .....	315

Custom Attributes in the ScienceLogic API .....	315
Using the ScienceLogic API to View, Create, and Edit Custom Attributes .....	315
Using a Dynamic Application to Create and/or Populate Custom Attributes .....	316
Using Custom Attributes to Define Device Groups .....	318
Viewing Custom Attributes in the Custom Table Widget .....	319

---

# Chapter

# 1

## Introduction



---

### Overview

This manual describes how to discover and collect data from devices in SL1. It also describes how to configure and manage those devices in SL1 after they have been discovered.

**NOTE:** For information about the data that SL1 collects from monitored devices, how to configure monitoring policies to collect that data, and how SL1 displays the data in the user interface, see the manual *Monitoring Device Infrastructure Health*.

Use the following menu options to navigate the SL1 user interface:

- To view a pop-out list of menu options, click the menu icon ().
- To view a page containing all of the menu options, click the Advanced menu icon (  ).

This chapter includes the following topics:

<i>What is a Device?</i> .....	9
<i>What is a Device Record?</i> .....	9
<i>What is a Device Class?</i> .....	10
<i>What is a Device Category?</i> .....	10
<i>How Does SL1 Manage Devices?</i> .....	11
<i>What is Discovery?</i> .....	12
<i>What is a Credential?</i> .....	12
<i>What is a Virtual Device?</i> .....	13



<i>What are Component Devices?</i> .....	14
<i>What is a Dynamic Application?</i> .....	14
<i>What is an SL1 Agent?</i> .....	15
<i>What is Virtualization?</i> .....	15
<i>What is an Asset Record?</i> .....	15

---

## What is a Device?

**Devices** are all networked hardware in your network. SL1 can monitor any device on your network, even if your organization uses a geographically diverse network. For each managed device, you can monitor status, create policies, define thresholds, and receive notifications (among other features). Some of the devices that SL1 can monitor are:

- Bridges
- Copiers
- Firewalls
- Load Balancers
- Modems
- PDU Systems
- Probes
- Printers
- Routers
- Security Devices
- Servers
- Switches
- Telephony
- Terminals
- Traffic shapers
- UPS Systems
- Workstations

In SL1, devices also include component devices and virtual devices.

---

## What is a Device Record?

As part of monitoring your network, SL1 collects data using common networking protocols. Most collected data is associated with a device in SL1. A **device record** in SL1 can represent:

- Physical network hardware, such as servers, switches, routers, or printers.
- A component of a larger system, such as a data store in a hypervisor system or a blade server.
- Any other entity about which you want to collect data, but want or need to associate that data with a container that does not correspond directly to a physical device or a component. For example, you might configure a device record that represents a web site or a cloud service.

---

## What is a Device Class?

Each device in SL1 is associated with a **device class**. Typically, device classes map to a make/model pair, such as *Product Name / Model Number*. SL1 includes already-defined device classes for the most popular hardware. When possible, SL1 automatically assigns each discovered device to an existing device class.

Device classes determine:

- How devices are represented in the user interface
- Whether the device is a physical device or a virtual device
- How managed devices are discovered with the discovery tool

SL1 includes already-defined device classes for the most popular hardware. The **Device Class Editor** page (System > Customize > Device Classes) allows advanced administrators to define new or legacy device classes in SL1 and to customize properties of existing device classes.

Most TCP/IP-compliant devices have an internally-defined class ID, called the System Object ID and abbreviated to SysObjectID. This SysObjectID is an SNMP OID defined by the manufacturer. Each manufacturer specifies a SysObjectID for each different hardware model. In SL1, each SNMP device class is associated with a SysObjectID. During initial discovery, SL1 searches each device for the SysObjectID and assigns each device to the appropriate device class.

SL1 also includes device classes for devices that do not support SNMP. These device classes are associated with values returned by nmap. SL1 runs nmap against each device during discovery.

The following sections describe the types of device classes used in SL1.

---

## What is a Device Category?

A **device category** is a logical categorization of a device by primary function, such as "server", "switch", or "router". SL1 uses device categories to group related devices in reports and views.

Device categories are paired with device classes to organize and describe discovered devices. Device class usually describes the manufacturer. Device category describes the function of the hardware. Each device class can include a device category.

**NOTE:** "Reserved" device categories are those device categories required by SL1. These device categories cannot be edited or deleted. If a device category does not display the bomb icon (💣), the device category is a reserved device category and cannot be deleted.

---

## How Does SL1 Manage Devices?

- Using discovery, SL1 automatically locates or *discovers* all hardware and hardware-components in your network. SL1 can also automatically discover most software applications running in your network.
- Using Dynamic Applications, SL1 can automatically discover component devices.
- During discovery, devices are categorized by device class and device category for quick identification. You can customize device classes and device categories and also define custom device classes and device categories.
- On the SL1 **Devices** and **Device Manager** pages, you can view details about each discovered device, including IP address and MAC address, operating system, hardware components (like CPU, RAM, swap, file systems), interfaces, open ports, and installed software.
- For each device, you can use the **Device Administration** panel or the **Device Investigator** page to define configuration and policies for the device.
- For each device, you can use the **Device Reports** panel or the **Device Investigator** page to view details about the device, including graphical reports.
- SL1 can monitor bandwidth usage for each discovered network interface. SL1 can generate reports and billing documents for each network interface.

**NOTE:** SL1 includes pre-defined events (sometimes called "alerts" in other applications). An **event** is a message that is triggered when a specified condition is met. Among other things, an event can signal that a server has gone down, that a device is exceeding CPU or disk-space thresholds, that communication with a device has failed, or simply display the status of a device or component. You can define and customize events to best fit your infrastructure. Events can be viewed through SL1, sent to users' email accounts, and sent to users' pagers or cell phones.

- You can define customized performance thresholds and hardware thresholds for a device. SL1 can generate events based on these thresholds.
- SL1 monitors availability and latency for each device. You can define availability and latency thresholds. SL1 also generates graphical reports on each device's availability and latency.
- SL1 monitors open ports. Based on user-defined policies, SL1 can generate an event when a new port is opened on any device in the network.
- SL1 can monitor port-availability for each port in the network.
- SL1 can discover and monitor the hardware components of each device.
- SL1 can discover and monitor the software running on each device.

- SL1 can monitor system processes and Windows services running on a device. Based on user-defined policies, SL1 can generate an event when a process or service is running or when a process or service is not running and should be.
- You can use **device groups** and **device templates** to automate the configuration and policies for multiple devices.
- You can create a virtual device to store data that you want to manage with SL1 but that cannot be associated with a traditional device or that you do not want associated with a traditional device.
- You can monitor **ESX servers** and **VMware "guest" devices** as you would monitor any other hardware-based device.
- You can create parent and child relationships between devices. These relationships allow you to use a single solution to resolve problems for the related devices.
- You can create **asset records** for one, multiple, or all devices in the network. SL1 automatically populates as many fields as possible, using information retrieved during discovery.
- SL1 includes an exhaustive list of real-time, dynamic, graphical reports to display trends and status for individual devices, groups of devices, or the entire network. These reports can be saved in multiple formats and can be printed.

---

## What is Discovery?

**Discovery** is the tool that automatically finds all the hardware-based devices, hardware components, and software applications in your network. You must provide the discovery tool with a range or list of IP addresses and/or a list of fully-qualified domain names (hostnames), and the discovery tool determines if a device, hardware component, or software application exists at each IP address. For each device, hardware component, or software application the discovery tool "discovers", the discovery tool can collect a list of open ports, DNS information, SSL certificates, list of network interfaces, device classes to align with the device, topology information, and basic SNMP information about the device.

The discovery tool also determines which (if any) Dynamic Applications to align with the device. If the discovery tool finds Dynamic Applications to align with the device, the discovery tool triggers collection for each aligned Dynamic Application.

For more information about discovery, see the **Discovery & Credentials** manual.

---

## What is a Credential?

**Credentials** are access profiles (usually username, password, and any additional information required for access) that allow SL1 to retrieve information from devices and from software applications on devices.

- Discovery uses SNMP credentials to retrieve SNMP information during initial discovery and nightly auto-discovery. If SL1 can connect to a device with an SNMP credential, SL1 deems that device "manageable" in SL1.
- Dynamic Applications use credentials to retrieve SNMP information, database information, SOAP information, XML information, XSLT information, and WMI information.

- Proxied Web Services use SOAP/XML Host credentials to pass authentication information to external web services.
- SL1 includes a type of credential called "Basic/Snippet" that is not bound to a specific authentication protocol. You can use this type of credential for Dynamic Applications of type "WMI", of type "snippet", and when defining system backups. "Basic/Snippet" credentials can also be used for monitoring Windows devices using PowerShell.
- SL1 includes a type of credential that allows SL1 to communicate with an LDAP or Active Directory system. For details on integrating SL1 with LDAP or Active Directory, see the manual **Using Active Directory and LDAP**.
- SL1 includes a type of credential that allows Dynamic Applications of type "Snippet" to use SSH to communicate with a remote device. To use these Dynamic Applications, you must define an SSH credential.
- SL1 includes a type of credential that allows Dynamic Applications to retrieve data from Windows devices. If you align a Dynamic Application for PowerShell with a PowerShell credential, SL1 assumes that you want to use its built-in agentless transport to communicate with Windows devices.

If necessary, a single device can use multiple credentials. If more than one agent or application is running on the device, each agent or application can be associated with its own credential. During discovery, SL1 will use the appropriate credential for each agent.

For example, suppose you want SL1 to discover a device that supports SNMP v2. To retrieve SNMP data from that device, SL1 must use a valid SNMP v2 read-only community string. So we would first go to the device and define the SNMP read-only community string. Then we would return to SL1 and create a credential in the SL1 system, using that community string. This new credential would allow discovery to retrieve SNMP data from the device.

Now suppose this same device also includes a MySQL database. Suppose you want SL1 to use a Dynamic Application to monitor that database. To retrieve data from the database, SL1 must use a valid username and password for that database. So we would first go to the device that hosts the MySQL database and create a database username and database password for SL1 to use. Then we would return to SL1 and create a credential in the SL1 system. The credential would include the database username and database password for the MySQL database. This credential would allow the Dynamic Application to retrieve data about the MySQL database.

For more information about credentials, see the **Discovery & Credentials** manual.

---

## What is a Virtual Device?

A **virtual device** is a container for collected data. A virtual device can be used when you want to:

- Monitor a device or application that doesn't support TCP/IP, SNMP, or both. The device's data can be pushed to SL1 via another method (for example, email) and stored in a virtual device.
- Monitor multiple SNMP agents on a single device. In such a case, one of the SNMP agents (for example, a hardware agent) can be associated with the device and another SNMP agent (for example, an agent that monitors a software application) can be associated with a virtual device.
- Isolate and monitor specific parameters separately from their originating device. For example, you might want to monitor a database and keep its data separate from the hardware data you are collecting from the host device.

For more information about virtual devices, see the **Virtual Devices** section.

---

## What are Component Devices?

SL1 uses Dynamic Applications to retrieve data from a management device and discover each entity managed by that management device. SL1 then uses that retrieved data to create a device for each managed entity. In some cases, the managed entities are nested.

- In SL1 a managed entity is called a **component device**. A component device is an entity that runs under the control of a physical management device.
- In SL1, the **root device** is the physical device that manages one or more component devices.
- In SL1, a **parent device** is a device that has associated entities modeled as component devices. A parent device can be either a root device or another component device.

For example, in a Cisco UCS system, SL1 might discover a physical server that hosts the UCS manager. SL1 might discover a chassis as a component device. The chassis is a child device to the physical server; the physical server is the root device. SL1 might also discover a blade as a component device that is part of the chassis. The blade is a child device to the chassis. The chassis is the parent device.

The **Device Components** page (Devices > Device Components) displays all root devices and component devices in an indented view, so you can easily view the hierarchy and relationships between child devices, parent devices, and root devices.

---

## What is a Dynamic Application?

**Dynamic Applications** are the customizable policies that tell SL1 what data to collect from devices and applications. For example, suppose you want to monitor a MySQL database running on a device in your network. Suppose you want to know how many insert operations are performed on the MySQL database. You can create or edit a Dynamic Application that monitors inserts. Every five minutes (for example), SL1 could check the number of insert operations performed on the MySQL database. SL1 can use the retrieved data to trigger events and/or to create performance reports.

SL1 includes Dynamic Applications for the most common hardware and software. You can customize these default Dynamic Applications to suit your environment. You can also create custom Dynamic Applications.

Dynamic Applications in SL1 support a variety of protocols to ensure that SL1 can always communicate with the devices and applications in your network and retrieve information from them. Dynamic Applications can use the following protocols to communicate with devices:

- SNMP
- SQL
- XML
- SOAP
- XSLT (uses SOAP and XSLT to convert XML data to a new format)
- WMI (Windows Management Instrumentation), including WMI and WBEM

- Windows PowerShell
- Custom Python applications (called "snippets") for proprietary or more complex data retrieval

---

## What is an SL1 Agent?

The **SL1 agent** is a program that you can install on a device monitored by SL1. The SL1 agent collects data from the device and pushes that data back to SL1.

Similar to a Data Collector or Message Collector, the SL1 Agent collects data about infrastructure and applications.

The agent can be configured to communicate with either the Message Collector or Compute Cluster.

The SL1 Extended Architecture supports aligning PowerShell Dynamic Applications to devices monitored by the SL1 Windows Agent. The SL1 Extended Architecture supports aligning JMX Dynamic Applications to devices monitored by the SL1 Linux Agent.

For more information about monitoring devices with the agent, see the **Monitoring with the SL1 Agent** manual.

---

## What is Virtualization?

**Virtualization** is when multiple virtual machines run on a single hardware platform. Each virtual machine is a software-based implementation of a computer that executes programs like a hardware-based computer. A virtual machine provides a platform on which you can run an operating system and software applications. For example, a single server could contain a virtual machine running Windows and Windows applications, another VM running Linux and Linux applications, another VM running BSD and BSD applications, and another running Macintosh OS and Macintosh applications.

A hypervisor is the software that allows one or more virtual machines to run on a single hardware platform. The hypervisor software allows the virtual machines to share the RAM, CPU, and disk space on the hardware platform.

Each virtual machine can run its own operating system. A virtual machine can provide an alternate instruction set from the hardware-based computer.

Virtual machines are frequently used to:

- Run multiple operating systems on a single computer.
- Consolidate hardware servers and run multiple server applications on a single server.
- Provide multiple, isolated development environments.

---

## What is an Asset Record?

An **asset record** is a collection of relevant information about an asset. In SL1, asset records are usually created for hardware devices.

In SL1, asset records can contain information about:

- The name, make, and model of a device.
- The serial number of a device.
- Function and status of the device.
- Networking information, like host ID, IP address, and DNS server for the device.
- Hardware information like amount of memory, CPU, and BIOS or EPROM version.
- Physical location of the device.
- Vendor information for the device, including PO or check number, warranty policy, and service policy.
- Description of the network interface.
- Description of each hardware component (if applicable).
- Description of installed software (if applicable).

SL1 will populate as many fields as possible automatically, using data retrieved during discovery and collections. You can enter values in all the fields or in only those fields that are required for your business processes.

You can specify which asset fields will be populated from data retrieved during discovery and collections and which fields will be populated manually. To specify this behavior, go to the **Asset Automation** page (System > Settings > Assets).



---

# Chapter

# 2

## Using the Devices Page



---

### Overview

The **Devices** page allows you to view all of your managed devices in SL1 and also run a discovery to find more devices to monitor. You can select a device from the list on the **Devices** page to view detailed data on the [Device Investigator](#) page for that device.

**NOTE:** The list of devices on the **Devices** page matches the list of devices on the **Device Manager** page (Devices > Device Manager).

Use the following menu options to navigate the SL1 user interface:

- To view a pop-out list of menu options, click the menu icon (.
- To view a page containing all of the menu options, click the Advanced menu icon (  ).

This chapter includes the following topics:

<a href="#">Viewing Devices</a> .....	17
<a href="#">Adding Devices with Discovery</a> .....	20
<a href="#">Assigning Icons to Devices</a> .....	20

---

### Viewing Devices

The **Devices** page allows you to view all of your managed devices in SL1. This section explains how to gather more information about a device from this page.

To navigate to the **Devices** page, click the Devices icon (🖨️):

The screenshot shows the SL1 'Devices' page. At the top, there's a search bar and an 'Add Devices' button. Below is a table of devices with columns: DEVICE NAME, IP ADDRESS, CATEGORY, CLASS, ORGANIZATION, ID, STATE, and COLLECTION STATE. Two devices are expanded, showing a 'Vitals' graph for 'em7ao' and a 'Tools' section. The 'Tools' section includes a log viewer with a search bar and a list of messages with dates, times, and severities (Notice, Major, Minor). Below the graph and tools is a scrollable list of many other devices, each with its own set of details.

For each device, the **Devices** page displays the following information:

- **Device Name.** Name of the device. For devices running SNMP or with DNS entries, the name is discovered automatically. For devices without SNMP or DNS entries, the device's IP address will appear in this field.
- **IP Address.** The device's IP address.
- **Category.** The category assigned to the device. Categories include servers, routers, switches, firewalls, and printers, among others. The category is automatically assigned during discovery, at the same time as the as Device Class. For more information about Device Categories, see the chapter on [Managing Device Classes and Device Categories](#).
- **Class.** The manufacturer and type of device. The Device Class is automatically assigned during discovery, at the same time as the Category. For more information about Device Classes, see the chapter on [Managing Device Classes and Device Categories](#).
- **Organization.** The Organization to which the device is assigned.
- **ID.** The Device ID. This is a unique number that SL1 automatically assigns to the device during discovery.

- **State.** The current condition of the device, based upon events generated by the device. The device can have one of the following States:
  - *Critical.* Device has a serious problem that requires immediate attention.
  - *Major.* Device has a problem that requires immediate attention.
  - *Minor.* Device has a less-serious problem.
  - *Notice.* Device has an informational event associated with it.
  - *Healthy.* Device is running with no problems.
- **Collection State.** The current condition of data collection for the device. The device can have one of the following Collection States:
  - *Active.* SL1 is collecting data from the device.
  - *Unavailable.* SL1 cannot connect to the device, and will not collect data from the device until the device becomes available.
  - *Disabled.* SL1 is not currently collecting data from the device.
  - *Component Vanished.* The component device has vanished, i.e. is not currently being reported by its root device. SL1 cannot collect data from the device at this time.
- **Hostname.** The fully qualified hostname for the device, for devices that are discovered and managed by hostname (instead of IP address).

**TIP:** To rearrange the columns in the List View, click and drag the column name to a new location. You can adjust the width of a column with by clicking and dragging the right edge of the column. You can click the **Select Columns** icon (⚙️) to add or remove columns, or to reset columns to their default settings.

**TIP:** To view the number of available devices, scroll down to the end of the list of devices and click the first checkbox next to the **Select Columns** icon (⚙️). The number of devices displays at the bottom of the screen. Click the first checkbox again to deselect all the devices, or click **Deselect All**.

## Viewing Additional Data about a Device

On the **Devices** page, you can click the **Expand** icon (⌵) next to a device name to open a drop-down panel called the **Device Drawer**. The Device Drawer contains additional data about that device:

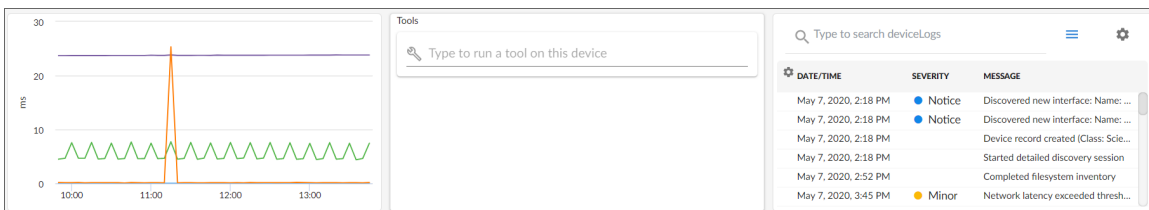

The Device Drawer contains the **Vitals** graphs, the **Tools** pane, and the **Logs** pane.

- The **Vitals** pane displays graph data for the past four hours of CPU usage, memory usage, and latency for that device, where relevant. You can zoom in on a shorter time frame in the **Vitals** graph by clicking and dragging, and you can go back to the original time span by clicking the **[Reset zoom]** button.
- The **Tools** pane enables you to run a set of network diagnostic tools in the **Activity Center**. Click the search bar to search for a tool or action to run, or click one of the default tools or actions that are available based on the device type and your user permissions. For more information, see the section on [Using the Activity Center](#).
- The **Logs** pane displays a list of events associated with that device.

**TIP:** From the list of devices, click the device name to go to the **Device Investigator** page for more details about that device. For more information, see the [Device Investigator](#) section.

## Aligning a Device with a Different Organization

To align a device with a different organization:

1. On the **Devices** page, click the **Actions** button (☰) for the device and select *Align Organization*. The **Align to Organization** window appears.

**TIP:** To align more than one device to an organization, select the checkboxes to the left of those devices and click *Align Organization* in the blue bar at the bottom of the screen.

2. In the **Align to Organization** window, use the **Organization** drop-down to search for and select an organization.
3. Click the **[Align Organization]** button. The organization you selected now appears in that *Info* drop-down on the **Device Investigator** page for that device.

---

## Adding Devices with Discovery

On the **Devices** page, you can click the **[Add Devices]** button to run a guided or unguided *discovery* session, a process that searches for and adds more devices to SL1 for monitoring.

For more information about adding devices using guided or unguided discovery, see the *Discovery & Credentials* manual.

---

## Assigning Icons to Devices

You can customize the look and feel of the devices that appear on the **Devices** page by assigning an icon a device, device class, or device category.

To assign an icon to a device, device class, or device category:

1. On the **Devices** page, **Device Classes** page (Devices > Device Classes), or **Device Categories** page (Devices > Device Categories), locate the device, class, or category for which you want to add an icon.
2. Click the **Actions** button (☰) for that item and select *Assign Icon*. The **Select an Icon** window appears:

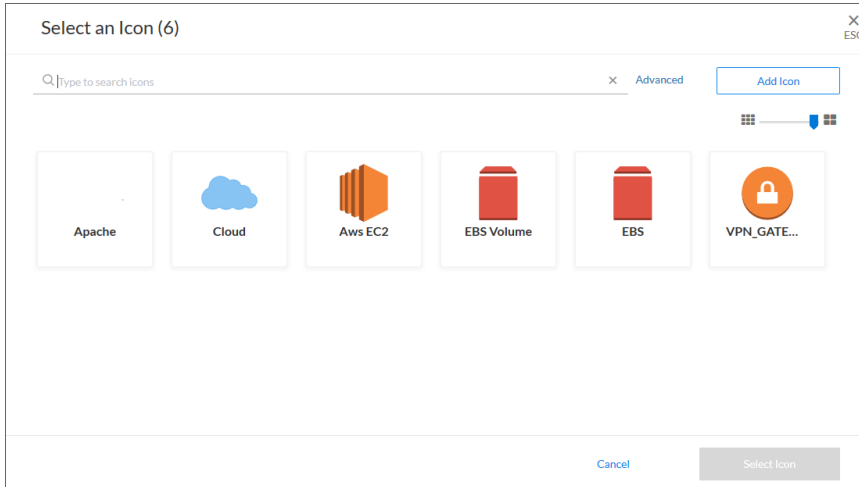

**TIP:** To assign an icon to more than one device, device class, or device category, select the checkboxes to the left of those items and click **Assign Icon** in the blue bar at the bottom of the screen.

3. To use an existing icon, select that icon from the list of icons and click the **[Select Icon]** button.

**TIP:** If an icon includes a tag, you can search for that icon by typing some or all of the tag text in the **Search** field.

4. To upload an icon from your local drive, make sure that the image file meets the following criteria:
  - The image file should be in .SVG format.
  - The file should not be larger than 40 KB.
  - The file should not be animated.
  - The file should not contain bitmaps.

5. To start the upload process, click the **[Add Icon]** button. The **Add an Icon** window appears:

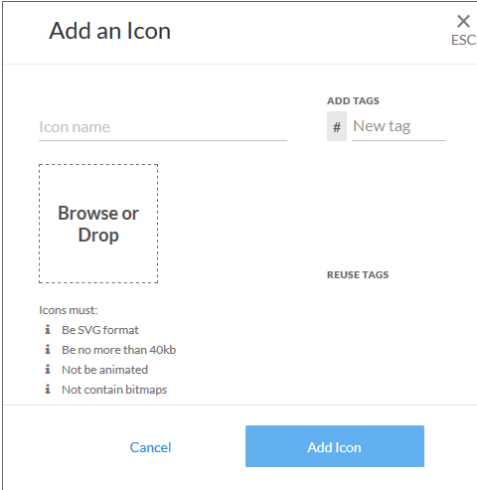

The screenshot shows a dialog window titled "Add an Icon" with a close button (X) and "ESC" key indicator in the top right corner. The dialog contains the following elements:

- An "Icon name" text input field.
- An "ADD TAGS" section with a "# New tag" input field.
- A dashed rectangular area labeled "Browse or Drop" for file selection.
- A "REUSE TAGS" section.
- A list of requirements under "Icons must:":
  - Be SVG format
  - Be no more than 40kb
  - Not be animated
  - Not contain bitmaps
- Two buttons at the bottom: "Cancel" and "Add Icon".

6. In the **Icon name** field, type a name for the icon you want to upload.
7. In the **Add Tags** field, type a short descriptor for the icon, without spaces. You can use this tag for searching later.
8. You can click the **Browse or Drop** area to browse for and select the icon, or you can drag and drop the icon file onto the **Add an Icon** window.
9. Click the **[Add Icon]** button. The icon is added to the **Select an Icon** window.
10. Click the **[Select Icon]** button to add the icon to the selected item.

---

# Chapter

# 3



## Using the Device Investigator

---

### Overview

The **Device Investigator** page provides a view of detailed data for a specific device. This chapter describes the **Device Investigator** page and all of the data that can be viewed on the page and its various tabs.

Use the following menu options to navigate the SL1 user interface:

- To view a pop-out list of menu options, click the menu icon ().
- To view a page containing all of the menu options, click the Advanced menu icon (  ).

This chapter includes the following topics:

<b>Using the Device Investigator</b> .....	<b>24</b>
<i>Using the Info Drop-Down on the Device Investigator Page</i> .....	28
<i>Running a Device Report</i> .....	29
<i>Using Device Tools in the Activity Center</i> .....	29
<b>Overview of the Device Investigator Tabs</b> .....	<b>31</b>
<i>The Investigator Tab</i> .....	31
Adding and Removing Metrics on the Investigator Tab .....	32
Editing the Metric Panel Order on the Investigator Tab .....	33
Combining Charts on the Investigator Tab .....	35
<i>The Settings Tab</i> .....	36
<i>The Attributes Tab</i> .....	40
<i>The Collections Tab</i> .....	40
<i>The Configs Tab</i> .....	41

<i>The Events Tab</i> .....	41
<i>The Interfaces Tab</i> .....	44
<i>The Journals Tab</i> .....	44
<i>The Machine Learning Tab</i> .....	45
<i>The Map Tab</i> .....	46
<i>The Monitors Tab</i> .....	46
<i>The Notes Tab</i> .....	47
<i>The Ports Tab</i> .....	48
<i>The Processes Tab</i> .....	49
<i>The Redirects Tab</i> .....	49
<i>The Relationships Tab</i> .....	50
<i>The Schedules Tab</i> .....	51
<i>The Services Tab</i> .....	52
<i>The Software Tab</i> .....	53
<i>The Thresholds Tab</i> .....	53
<i>The Tickets Tab</i> .....	54

## Using the Device Investigator

You can view detailed data about a specific device by clicking the device name on the **Devices** page to open the **Device Investigator** page for that device:

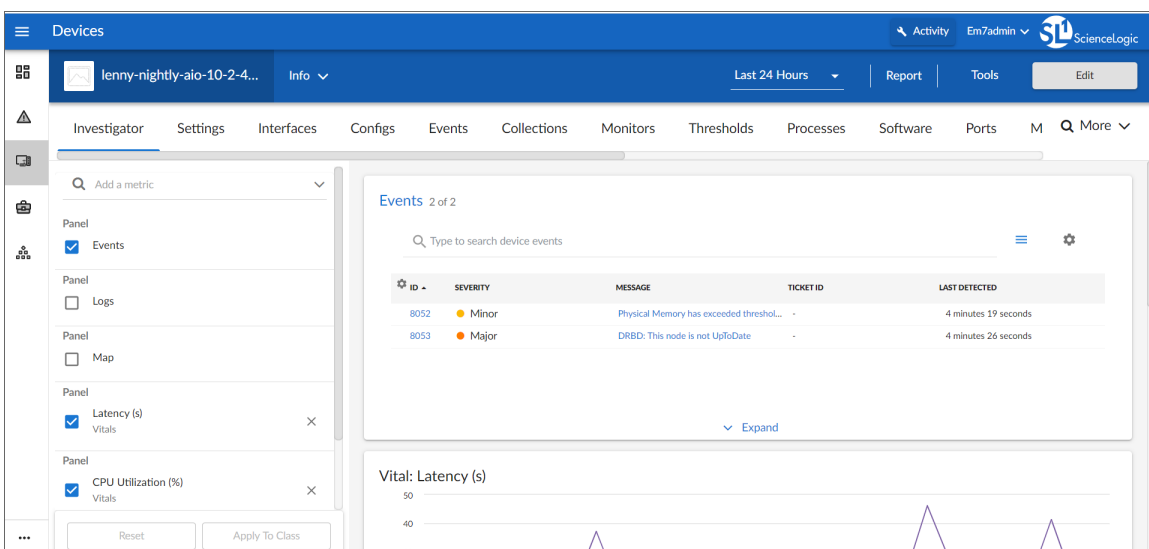

The tabs on the **Device Investigator** page provides access to all the data associated with a device. The tabs are similar to the tabs on the **Device Administration** and **Device Properties** panels in the classic user interface.



Only tabs relevant to the selected device are available on the **Device Investigator** page. For example, the **[Agent]** and **[Interfaces]** tabs do not display if the selected device does not use agents or interfaces. Also, widgets on the **[Investigator]** tab display as "Empty" where no metrics exist for that widget.

The **Device Investigator** page can include the following menus and buttons:

- **Info**. This drop-down list on the **[Investigator]** tab displays additional information about the device, along with the most recently updated values for uptime and collection time.
- **Time span filter**. This drop-down list on the **[Investigator]** tab allows you to adjust the time span that appears in all the metrics on the **[Investigator]** tab. The default filter is *Last 24 Hours*.
- **Report**. This button lets you generate a detailed report on the device.
- **Tools**. This button opens the **Activity Center**, where you can run a set of diagnostic tools or user-initiated actions.

The **Device Investigator** page contains the following tabs:

- **Investigator**. Displays metrics about a device. For most devices, the default metrics include Logs and the three Vitals: CPU Utilization (percentage), Physical Memory (percentage), and Latency (milliseconds). You can select additional metrics from the **Add a metric** drop-down list under the **Device List** pane on the left side of the screen. You can also compare devices on this tab.
- **Settings**. Lets you manage your preferences for that device, such as whether to auto-clear events, accept all logs, run daily port scans, and more. You can also set user maintenance preferences and disable or enable collection on that device.
- **Attributes**. Lists the custom descriptive fields that are currently aligned with this device. On this tab, you can add and remove extended custom attributes to this device.
- **Collections**. Lets you align or unalign Dynamic Applications with this device, enable or disable collection for the Dynamic Applications, and run a Dynamic Application. You can also change credentials and update the poll frequency for a Dynamic Application.
- **Configs**. Displays configuration information collected from the device by Dynamic Applications. If this device does not have any configuration data, this tab does not appear.
- **Events**. Displays a list of active and cleared events for the device. You can acknowledge events from this tab and add event notes.
- **Interfaces**. Displays information about the interfaces used by the device. If this device does not use interfaces, this tab does not appear.
- **Journals**. Displays journal entry information collected from the device by Dynamic Applications.
- **Machine Learning**. Displays a list of machine learning metrics that are enabled for the device.
- **Map**. Opens a map of that device and the devices it is related to (for systems that have the **Maps** page enabled).
- **Monitors**. This tab lets you define monitoring policies for the device.
- **Notes**. Displays notes and attachments associated with the device. You can also edit and create notes.
- **Ports**. Displays a list of all open ports on the device.
- **Processes**. Displays a list of system processes running on the device.
- **Redirects**. Allows you to redirect logs entries from an IP-based device to the current device. This is most useful when the current device is a virtual device.
- **Relationships**. Displays information about parent-child relationships between devices.

- **Schedules.** Allows you to view and manage all the scheduled processes you have defined in your system.
- **Services.** Displays a list of all Windows services enabled on the device.
- **Software.** Displays a list of all the software installed on the device.
- **Thresholds.** Lets you define space and performance thresholds for a device.
- **Tickets.** Displays all open, pending, or working tickets associated with the device.
- **More.** This drop-down lets you select additional tabs to display on the **Device Investigator** page by clicking the star icon next to the tab name. You can search for specific items on a tab, such as Device Class, Uptime, or Category, and the relevant tab will appear in the search results. You can also remove a tab by clicking the star icon again, turning it from blue to white. Your tab selections are saved and remain in place even after you log out:

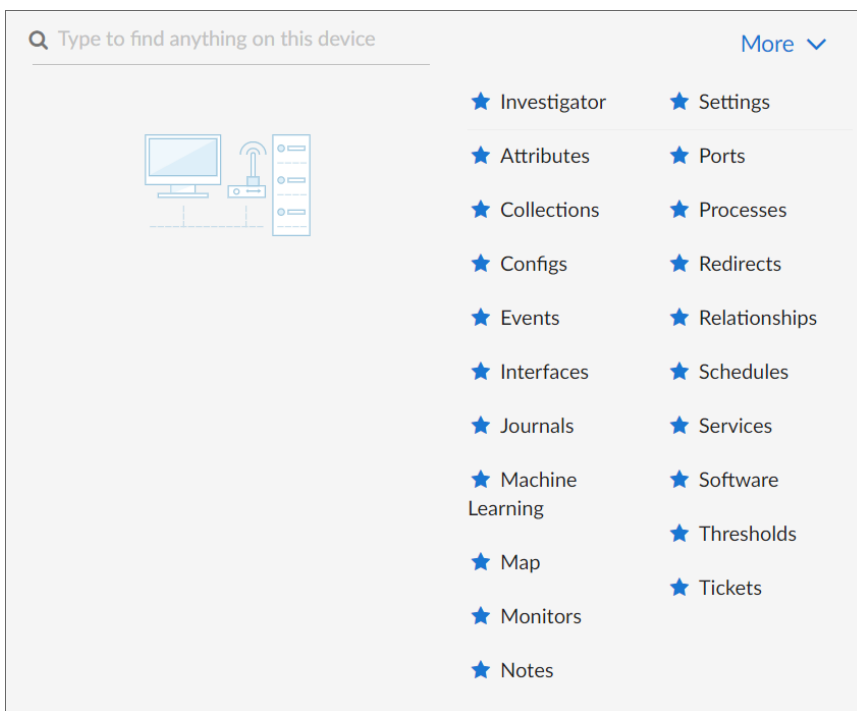

**TIP:** Click the forward-slash button (/) to open the **More** drop-down. You can highlight search results using the Up and Down Arrow keys on your keyboard, and select a result by pressing **Enter**. To close the drop-down, click the word **More**.

## Using the Info Drop-Down on the Device Investigator Page

On the **Device Investigator** page, you can view read-only information about the device in the **Info** drop-down list:

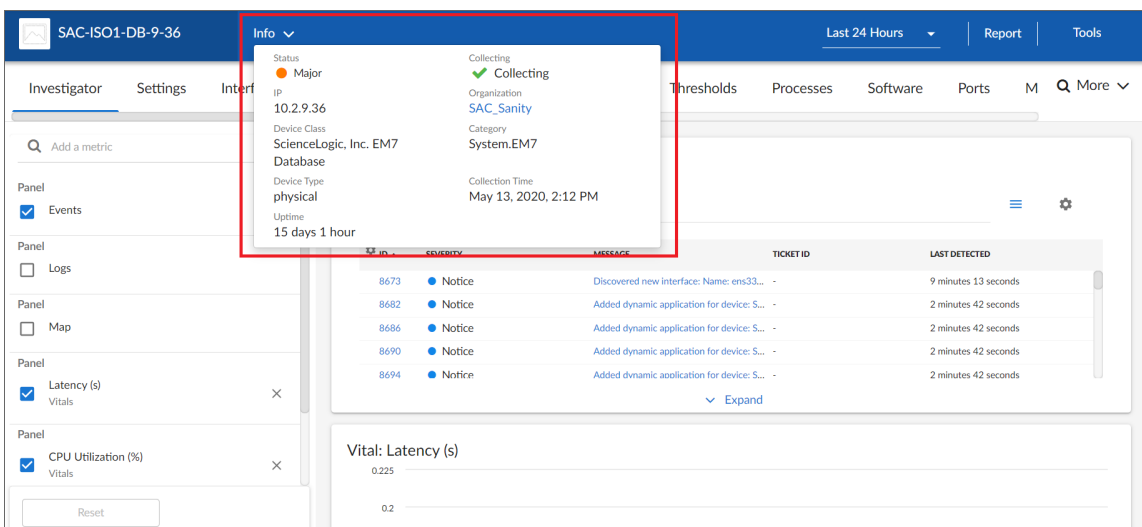

The **Info** drop-down displays the following information for the device:

- **Status**. The status of the device.
- **Collecting**. Indicates that the device collection is "Collecting" with a green check mark icon (✓), meaning SL1 is periodically collecting data from the device, or "Not Collecting" with a prohibition icon (⊘), meaning the SL1 is not currently collecting data from the device.
- **IP**. IP address of the device.
- **Organization**. The organization to which this device belongs. Click the organization name to view a detail page for the organization.
- **Device Class**. Device class for the device. A **device class** usually describes the manufacturer of the device.
- **Category**. The device category associated with the device. The **device category** usually describes the primary function of the device, such as a "server", "switch", or "router".
- **Device Type**. Specifies whether the device is a physical device or a virtual device.
- **Collection Time**. Date and time of the most recent collection.
- **Uptime**. The number of days and hours that the device has been continuously up and communicating with SL1.
- **More Attributes**. This lower section lists any custom attributes that might be aligned with this device.

## Running a Device Report

On the **Device Investigator** page, you can generate a detailed report on that device. You can specify the information to include in the report and the format that SL1 will use to generate the report, including HTML, PDF, XLS, and more.

1. On the **Device Investigator** page, click the **[Report]** button in the top navigation bar. The **Device Report** modal page appears.
2. From the **Select Type** drop-down, select the type of report you want to generate. You can select *Full Report* to get all of the metrics, or you can select a single metric for the device, such as *Status*, *Processes*, or *Health*.
3. In the **Select Format** drop-down, select the format for the report. Options include *HTML*, *PDF*, *DOC*, *XLS*, or *CSV*.
4. Click **[Create Report]** to generate the report.

## Using Device Tools in the Activity Center

On the **Device Investigator** page, you can click the **Tools** menu to display the **Activity Center**. The **Activity Center** enables you to run a set of network diagnostic tools.

**NOTE:** The tools and actions that are available in the **Activity Center** are based on the device type and your user permissions, as determined by your organization assignment and access hooks. For example, if a device does not have an IP address, only the Availability tool will be available.

To run device tools or user-initiated actions in the **Activity Center**:

1. On the **Device Investigator** page, click the **[Tools]** button in the top navigation bar, or click **[Activity]** in the navigation bar at the top of any page in SL1. The **Activity Center** appears:

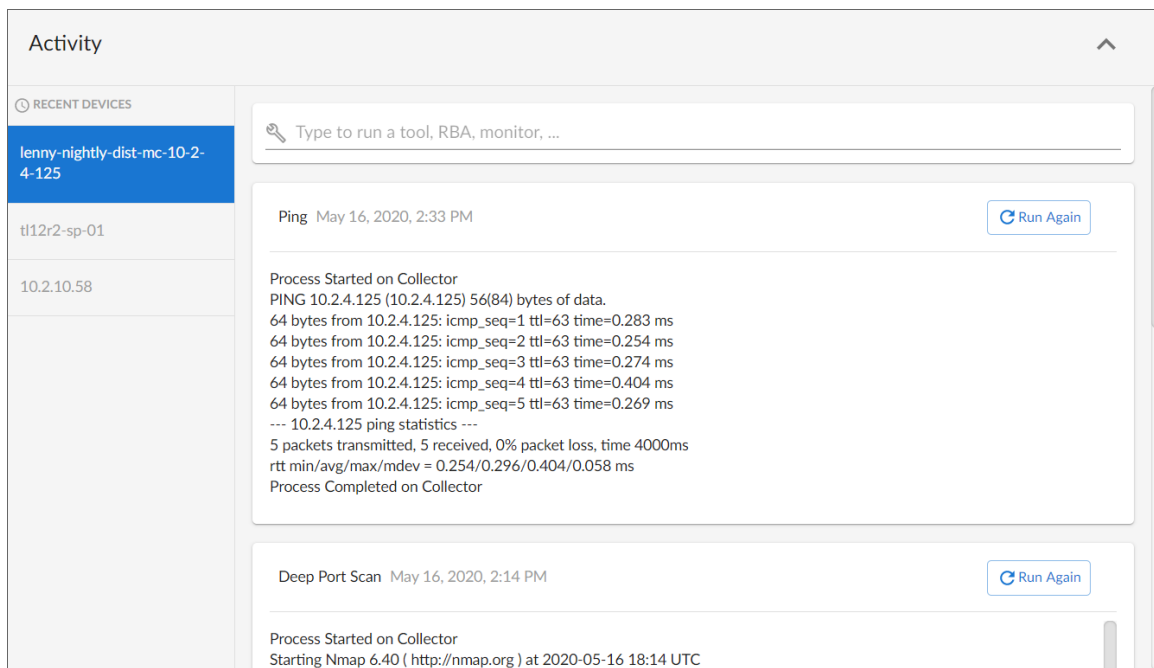

2. The left pane of the **Activity Center** displays a list of the 10 devices for which you have most recently used the **Activity Center**, with the current device at the top of the list. To use the **Activity Center** for any of the other recently used devices or to view historical logs for the tools or actions that have been run on those devices, click on the device name.
3. Click the search bar. A list appears of the default tools or actions that are available for the selected device. Click one of these tools or actions, or use the search bar to search for a tool or action that is not listed. The following default tools are available in the **Activity Center**:
  - **Availability**. Displays the results of an availability check of the device, using the port and protocol specified in the **Availability Port** and **Availability Protocol** fields on the **[Settings]** tab for this device.
  - **Ping**. Displays statistics returned by the ping tool. The ping tool sends a packet to the device's IP address (the one used by SL1 to communicate with the device) and waits for a reply. SL1 then displays the number of seconds it took to receive a reply from the device and the number of bytes returned from the device. If the device has an IPv6 address, SL1 uses the appropriate IPv6 ping command.
  - **Whols**. Displays information about the device's IP, including the organization that registered the IP and contacts within that organization.
  - **Port Scan**. Displays a list of all open ports on the device at the time of the scan.
  - **Deep Port Scan**. Displays a list of all open ports and as much detail about each open port as the deep port scanner can retrieve.
  - **ARP Lookup**. Displays a list of IP addresses for the device and the resolved Ethernet physical address (MAC address) for each IP address.
  - **ARP Ping**. Displays the results from the ARP Ping tool. The ARP Ping tool is similar in function to ping, but it uses the ARP protocol instead of ICMP. The ARP Ping tool can be used only on the local network.

- **Trace Route.** Displays the network route between SL1 and the device. The tool provides details on each hop to the endpoint. If the device has an IPv6 address, SL1 uses the appropriate IPv6 traceroute command.

**TIP:** The tools found in the **Activity Center** can also be found in the **Device Toolbox** in the classic SL1 user interface.

4. As the selected tool or action runs, its progress and results appear in a log in the **Activity Center**.
5. After the tool or action has run, if you want to run it again, click the **[Run Again]** button. This button appears only for activities completed during your current session.

## Overview of the Device Investigator Tabs

The following section provides an overview of how to use the tabs on the **Device Investigator** page for a selected device.

### The Investigator Tab

The **[Investigator]** tab of the **Device Investigator** page displays a customizable set of metrics about the selected device. Each metric displays in a panel in the right-hand pane:

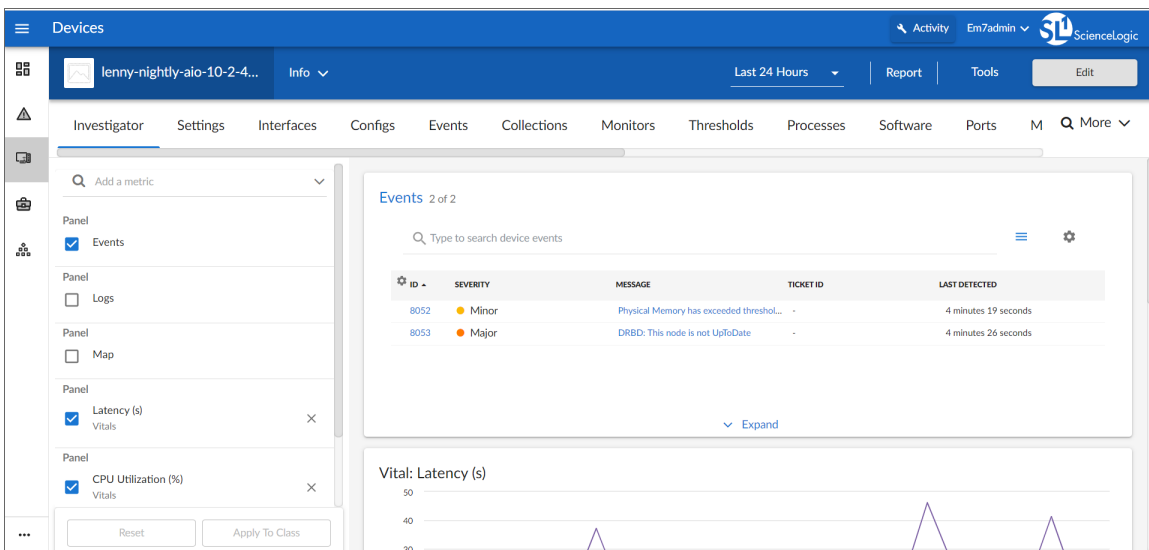

The list of metrics that appears in the left-hand pane depends on the type of device. For most devices, the following metrics appear by default:

- **Events.** Displays a panel with the list of events aligned with this device. In the right-hand pane, you can click the **ID** or **Message** field to view the **Event Investigator** page for that event. You can also click the **Events** panel heading to go to [the \[Events\] tab](#) for that device.
- **Logs.** Displays a panel with a list of the logs for the device, sorted from newest to oldest by default. You can use the **Search** field to search device logs for specific event messages, event IDs, date ranges, source types, and other relevant text for troubleshooting. You can also click on the column headers for **Date/Time**, **Source**, **Event ID**, **Severity**, and **Message** to sort by that column.
- **Map.** Displays a panel with a map of the device and all of the devices with which the device has relationships. You can also click the **Map** panel heading to go to [the \[Map\] tab](#) for that device.
- **Latency.** Displays a panel for latency for the device over time, in milliseconds. Latency means the amount of time it takes SL1 to communicate with the device.
- **CPU Utilization.** Displays a panel for the total amount of CPU used over time, as a percentage of all available CPU.
- **Physical Memory Utilization.** Displays a panel for the physical memory usage over time, in percent.

**TIP:** In the right-hand pane, you can click Expand at the bottom of a panel to make that panel bigger.

## Adding and Removing Metrics on the Investigator Tab

Optionally, you can add metrics to the **[Investigator]** tab for Dynamic Applications, interfaces, and the SL1 agent (if applicable), among other things. You can also remove metrics from the **[Investigator]** tab.

To add and remove metrics on the **[Investigator]** tab:

1. To add a metric that is not currently in the left-hand pane, click the **Add a metric** field. A list of metrics appears:

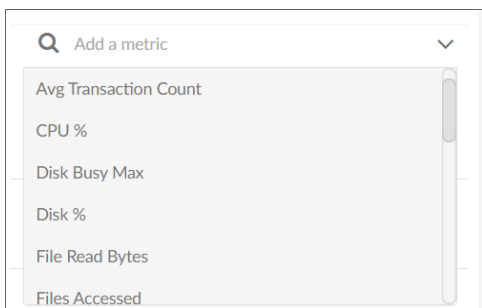

2. Select a metric from the list, or type the name of a metric and select it from the list. The metric is added to the left-hand pane, and a corresponding widget appears in the right-hand pane.
3. Some metrics might require you to make additional selections, such as the network interfaces associated with a device. Click the field and add one or more additional metrics, as needed.



**NOTE:** You can select up to eight additional metrics per widget.

4. To remove the widget for a metric from the right-hand pane, click the check mark icon (  ). The metric remains in the left-hand pane, but the widget is removed from the right-hand pane.
5. To completely remove the metric and the widget from the **[Investigator]** tab, click the **[Clear]** button (  ) for that metric in the left-hand pane.

**NOTE:** The **[Investigator]** tab retains any changes you made to the set of device metrics displayed for each device, on a per-user basis. To reset these changes to their default settings, click the **[Reset]** button at the bottom of the left-hand pane. To apply these changes to every device in the device's device class, click the **[Apply To Class]** button at the bottom of the left-hand pane.

## Editing the Metric Panel Order on the Investigator Tab

On the **[Investigator]** tab of the **Device Investigator** page, the order in which the metric panels appear in the left-hand pane mirrors the order in which the corresponding metric widgets appear in the right-hand pane. You can drag and drop the panels up or down in the left-hand pane to edit the order in which the metric panels appear on the right-hand pane. This enables you to prioritize the information that appears on the page.

To edit the order in which widgets appear on the **[Investigator]** tab:

1. On the **[Investigator]** tab of the **Device Investigator** page, in the left-hand pane, hover your mouse over the "Panel" heading until you see an open hand icon appear:

ID	SEVERITY	MESSAGE	TICKET ID	LAST DETECTED
3763	Healthy	SSL certificate has been renewed: expire...	-	16 hours 52 minutes
24234	Minor	Physical Memory has exceeded threshol...	-	3 minutes 21 seconds
27194	Minor	App: 15, Snippet: 8 reported a collection...	-	18 minutes 41 seconds

- Click and hold down the left button on your mouse to grab the panel, and then use your mouse to drag the panel to a different location in the left-hand pane. When you do so, the open hand icon becomes a closed hand icon, and a blue dotted box appears around the panel.

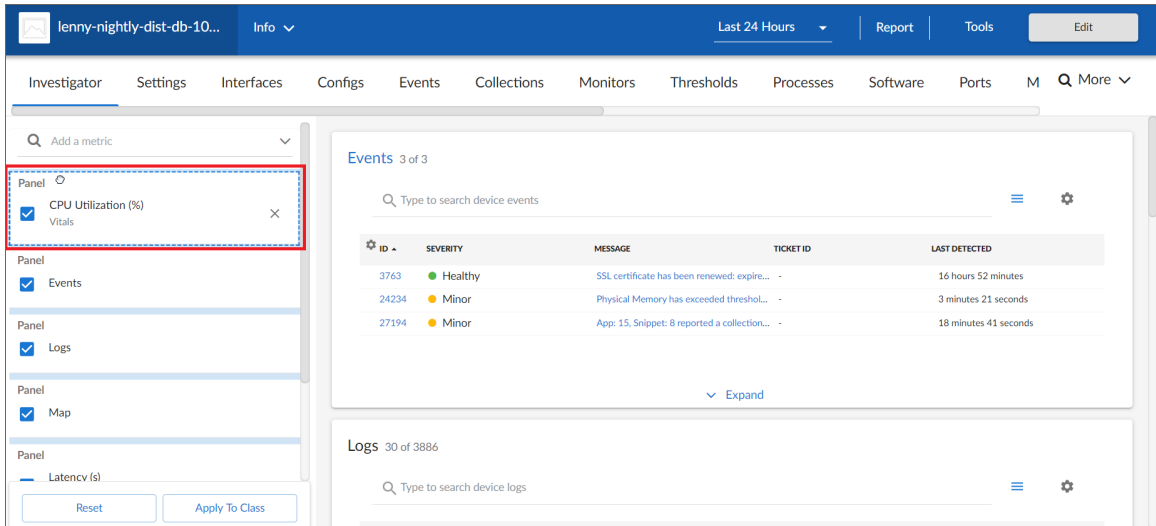

- Release the left mouse button to drop the panel in your desired location. The new left-hand panel order will be reflected in the right-hand widget pane.

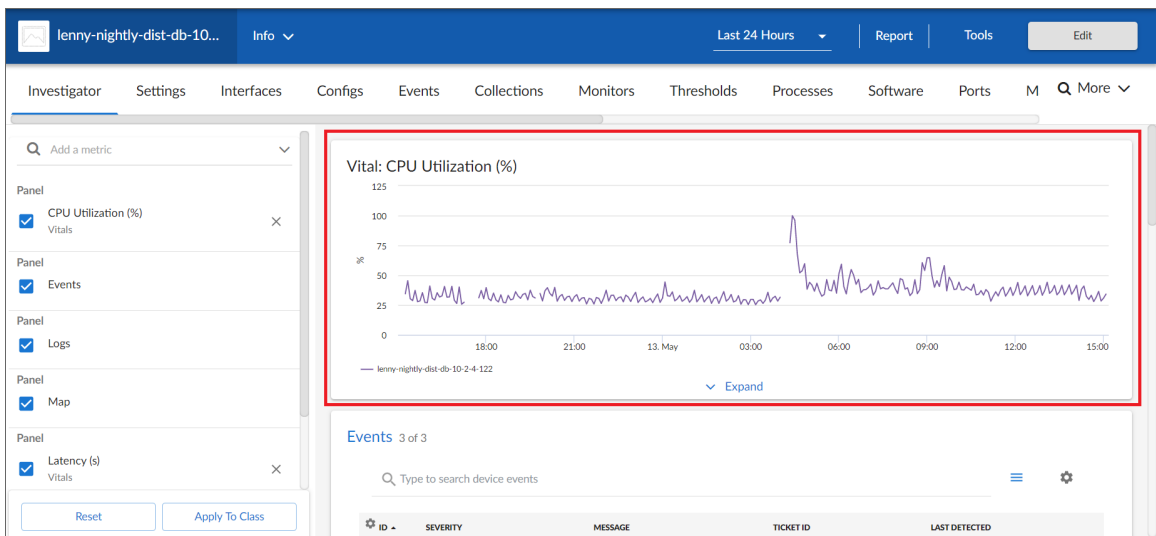

**NOTE:** The **[Investigator]** tab retains any changes you made to the set of device metrics displayed for each device, on a per-user basis. To reset these changes to their default settings, click the **[Reset]** button at the bottom of the left-hand pane. To apply these changes to every device in the device's device class, click the **[Apply To Class]** button at the bottom of the left-hand pane.

## Combining Charts on the Investigator Tab

On the **[Investigator]** tab of the **Device Investigator** page, you can combine charts for different time-series metrics to see all of the combined data for those metrics in a single chart.

To combine charts:

1. On the **[Investigator]** tab of the **Device Investigator** page, in the left-hand pane, hover your mouse over a time-series metric name until you see an open hand icon appear.

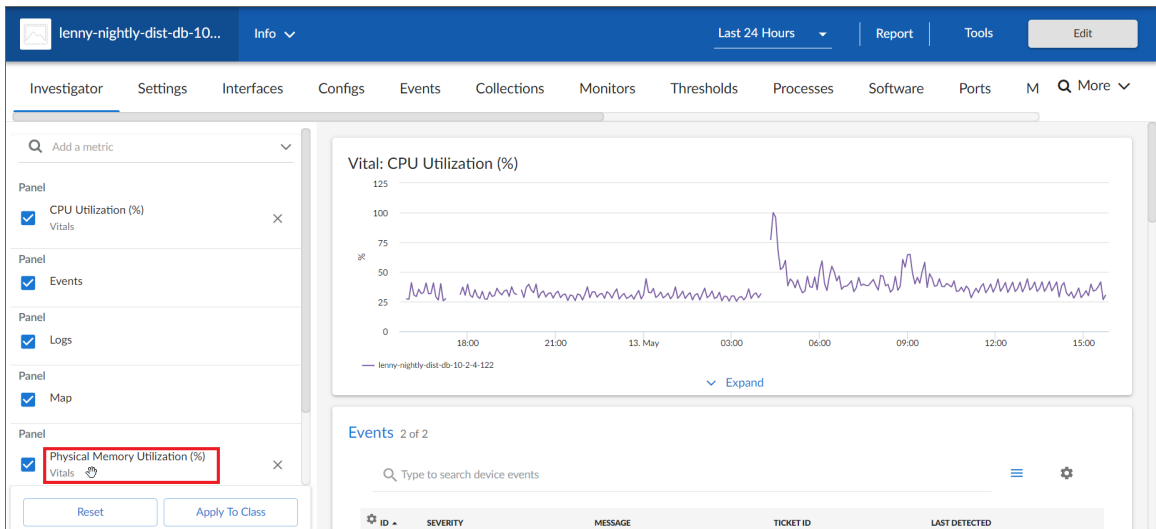

2. Click and hold down the left button on your mouse to grab the metric, and then use your mouse to drag the metric into the panel of a different time-series metric in the left-hand pane. When you do so, the open hand icon becomes a closed hand icon, and the panel containing the combined metrics turns blue.

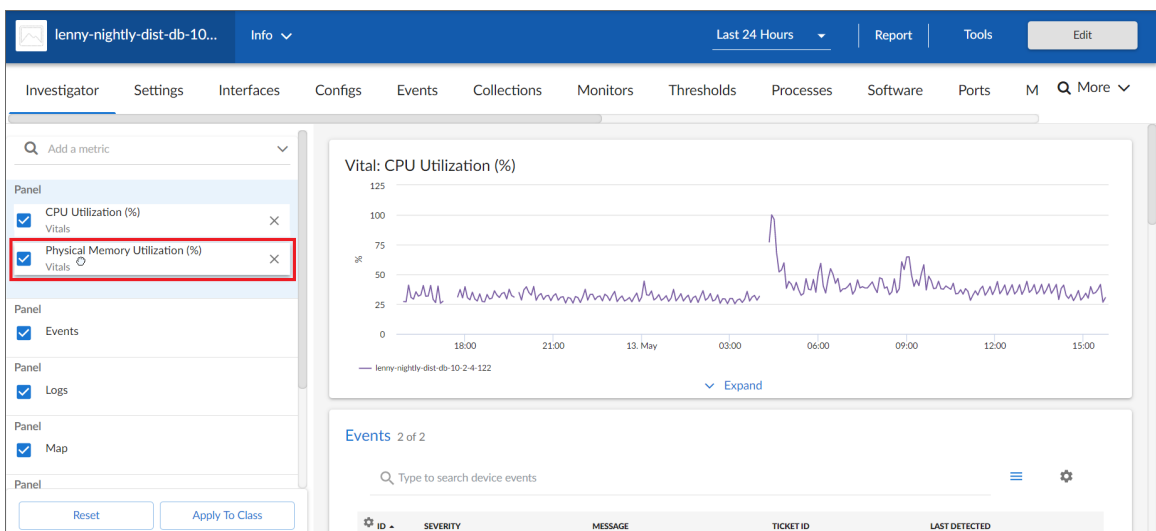

3. Release the left mouse button to drop the metric into the desired panel. The newly combined metric panel will be reflected in a "Combined Charts" widget in the right-hand pane.

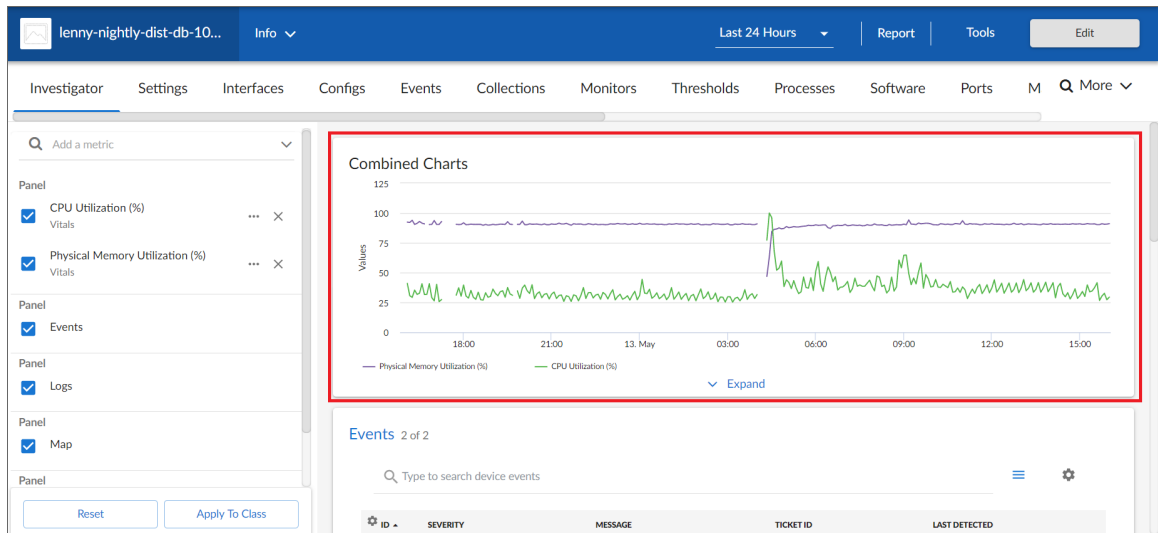

**NOTE:** The **[Investigator]** tab retains any changes you made to the set of device metrics displayed for each device, on a per-user basis. To reset these changes to their default settings, click the **[Reset]** button at the bottom of the left-hand pane. To apply these changes to every device in the device's device class, click the **[Apply To Class]** button at the bottom of the left-hand pane.

## The Settings Tab

On the **[Settings]** tab of the **Device Investigator** page, you can manage your preferences for that device, such as whether to auto-clear events, accept all logs, run daily port scans, and more.

Click the **[Edit]** button to change your settings. When you are done making changes, click **[Save]**.

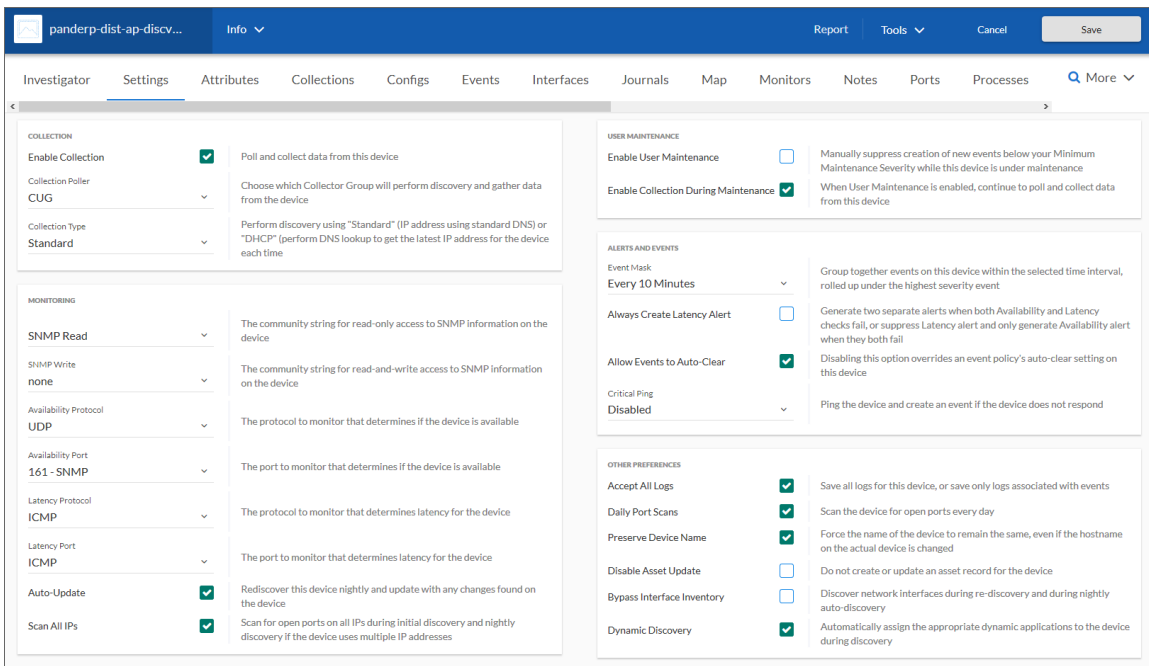

**NOTE:** The **Agent** section appears only for agent-type devices.

Set the following **Agent** data collection preferences:

- **Disk Space.** Specify the amount of disk space in MB that the agent can use to store data. If the agent loses connectivity to SL1, this disk space will be used to store collected data until the connection to SL1 is restored. When connectivity is re-established, the agent uploads all of its stored data.
- **Excludes.** Type a list of processes and directories, separated by semi-colons, that you do not want the agent to monitor.
- **Includes.** Type a list of processes and directories, separated by semi-colons, that you want the agent to monitor. This field ensures that specific processes are monitored.

**NOTE:** If a process or directory is included in both the **Excludes** field and the **Includes** field, the item in the **Includes** field will override the item in the **Excludes** field.

- **Collect File Information.** Select this option if you want the agent to report the names of files accessed by each monitored process.
- **Collect Named Pipe Information.** Select this option if you want the agent to collect named pipe information.
- **Collect Socket Information.** Select this option if you want the agent to collect socket information.
- **Collect Thread Information.** Select this option if you want the agent to collect thread information.
- **Collect Non-Intercepted Processes.** Select this option if you want the agent to collect limited information for processes that do not contain the agent library.
- In the **Processes Aggregation** drop-down, specify how you want the agent to collect limited information for processes that do not have the agent library in them, and how to aggregate short-lived processes. Your options include the following:
  - *All:* Aggregate every short-lived process into its parent.
  - *None:* Do not aggregate any short-lived process.
  - *Without Sockets:* Aggregate short-lived processes unless those processes have sockets.

Set the following **Collection** preferences:

- **Enable Collection.** Select this option to enable collection using the collector group specified in the following field.
- **Collection Poller.** Select the name of collector group you want to use for collection on this device.
- **Collection Type.** Select the type of collection you want to use on this device. Your options include *Standard* or *DHCP*.

Set the following **Monitoring** preferences:

- **SNMP Read.** Select the community string for read-only access to SNMP information on the device.
- **SNMP Write.** Select the community string for read-and-write access to SNMP information on the device.
- **Availability Protocol.** Select the protocol to monitor that determines if the device is available.
- **Availability Port.** Select the port to monitor that determines if the device is available.
- **Latency Protocol.** Select the protocol to monitor that determines latency for the device.
- **Latency Port.** Select the port to monitor that determines latency for the device.
- **Auto-Update.** This checkbox specifies whether or not you want SL1 to perform a nightly discovery of the device and update records with changes to the device. If this field is unchecked, SL1 will not perform nightly discovery. Changes to the device, including newly opened ports, will not be recorded by SL1.
- **Scan All IPs.** If the device uses multiple IP Addresses, SL1 will scan for open ports on all IPs during initial discovery and nightly discovery.

Set the following **User Maintenance** preferences:

- **Enable User Maintenance.** Specifies whether the device is in user maintenance mode. User maintenance is an option that allows a user to manually put a device in to "maintenance mode". During maintenance mode, for the selected devices, SL1 generate only events with a severity less than the system-wide **Maintenance Minimum Severity** setting. If you select *Enabled*, the device is put in user maintenance mode, and the device will remain in this state until you or another user disables user maintenance mode.
- **Enable Collection During Maintenance .** Specifies whether SL1 will poll the device when user maintenance mode is enabled. If you select *Enabled*, SL1 will continue to poll and collect data from this device during user maintenance mode.

Set the following **Alerts and Events** preferences:

- **Event Mask.** Specify the time frame for masking events. When a device uses the Event Mask setting, SL1 groups together events that occur on that device within the specified span of time.
- **Always Create Latency Alert.** Select this option to generate two alerts when availability and latency checks fail. Deselect to generate only an availability alert and suppress latency alerts.
- **Allow Events to Auto-Clear.** Deselect this option to override an event policy's auto-clear setting for this device.
- **Critical Ping.** Pings the device and creates an event if the device does not respond. When enabled you can select between 5 and 120 seconds.

Set the following **Other** device preferences:

- **Accept All Logs.** This checkbox specifies whether or not you want to keep and save all logs for this device. If you want to retain only logs associated with events, uncheck this field.
- **Daily Port Scans.** This checkbox specifies whether or not you want SL1 to perform a daily scan of the device for open ports.
- **Preserve Device Name.** If selected, the name of the device in SL1 will remain the same, even if the name of the actual device is changed. If unselected, the SL1 name for the device will be updated if the name of the actual device is changed.
- **Disable Asset Update.** If selected, SL1 will not automatically create a new asset record for the device or update the existing asset record for the device. For the single device, this checkbox over-rides any settings defined in the **Asset Automation** page (System > Settings > Assets).
- **Bypass Interface Inventory.** Specifies whether or not the discovery session should discover network interfaces. Your options include:
  - *Selected.* SL1 will not attempt to discover interfaces for this device during re-discovery and nightly auto-discovery.
  - *Not Selected.* SL1 will attempt to discover network interfaces for this device during re-discovery and nightly auto-discovery using the **Interface Inventory Timeout** value and **Maximum Allowed Interfaces** value specified in the **Device Thresholds** page.
- **Dynamic Discovery.** If selected, SL1 will automatically assign the appropriate dynamic applications to the device during discovery.

## The Attributes Tab

On the **[Attributes]** tab of the **Device Investigator**, you can view a list of list of custom attributes that are already aligned with that device, and you can also add and remove extended custom attributes for the device:

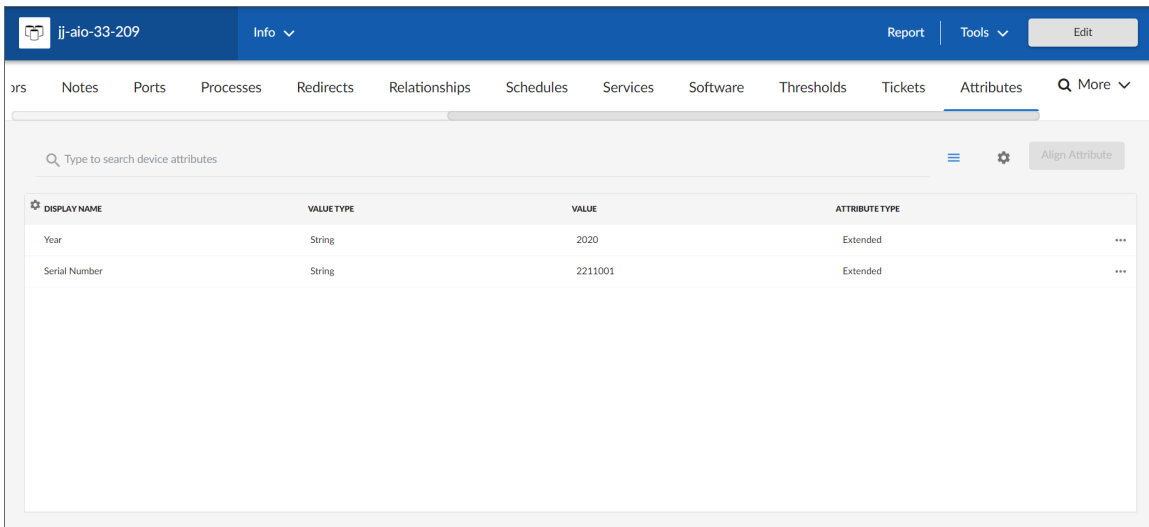

**NOTE:** For more information about this tab, see the section on [Adding Custom Attributes for a Device](#).

## The Collections Tab

On the **[Collections]** tab of the **Device Investigator**, you can view a list of the Dynamic Applications associated with the device:

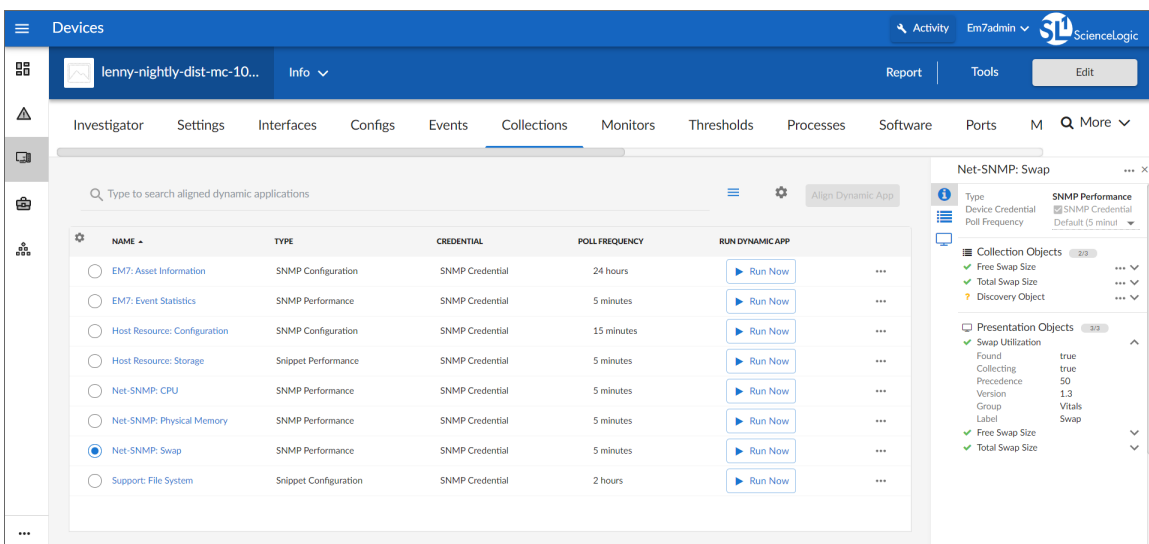



**NOTE:** For more information about this tab, see the section on [Managing the Dynamic Applications Associated with a Device](#).

## The Configs Tab

On the **[Configs]** tab of the **Device Investigator**, you can view configuration information that has been collected from the device by Dynamic Applications:

The screenshot shows the Cisco Device Investigator interface for a device named 7609S-NPE3.cisco.com. The 'Configs' tab is active, displaying a sidebar with various configuration categories and a main content area with three sections:

- Cisco: VLAN Configuration - VLAN Information**: A table listing VLANs with columns for MTU, Name, Type, State, and ID.
- Cisco: VLAN Configuration - VTP Statistics**: A table showing VTP statistics with columns for digest errors, revision numbers, and advertisement counts.
- Cisco: FRU Control Configuration - Module Status**: A table showing the status of hardware modules with columns for model name, name, admin status, operation status, state change reason, transition time, and serial number.

All objects of type "config" are included on the **[Configs]** tab. Usually, "config" objects contain static information about hardware and configuration settings, such as serial numbers, version numbers, and hardware status.

**NOTE:** For more information about this tab, see the chapter on "Viewing Configuration & Journal Data" in the *Monitoring Infrastructure Health* manual.

## The Events Tab

On the **[Events]** tab of the **Device Investigator**, you can view a list of events associated with the device:

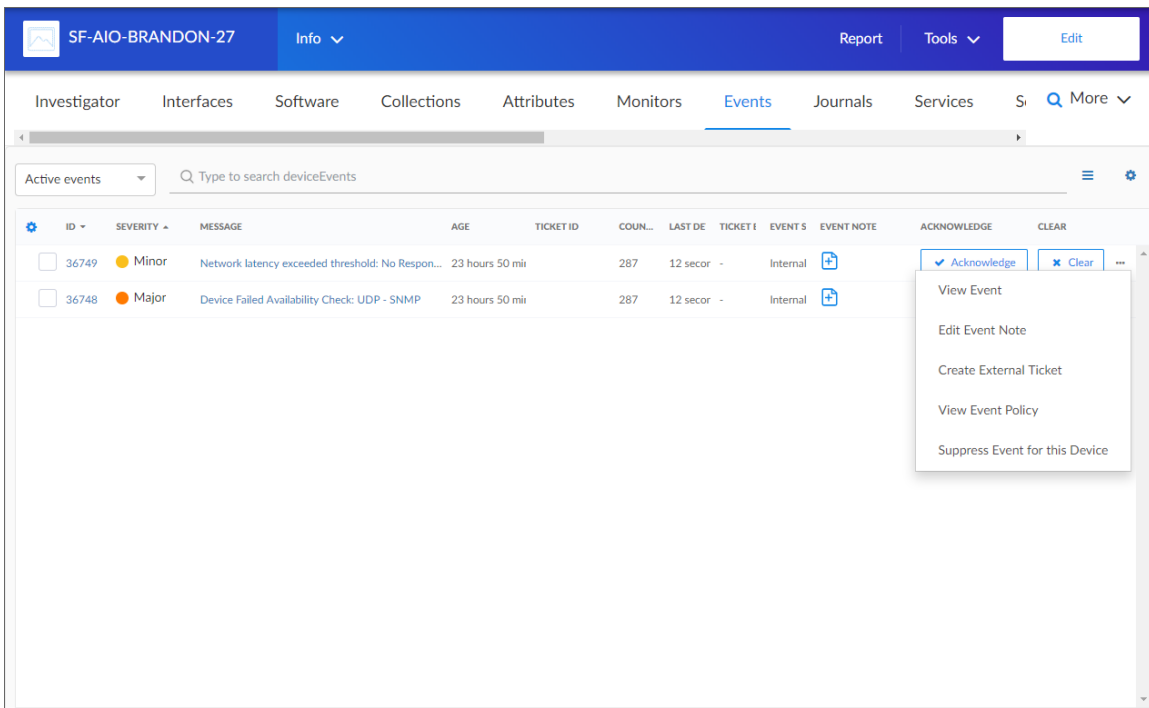



For each event, the **[Events]** tab displays the following information:

- **ID**. The unique ID for the event, generated by SL1. The ID appears as a hyperlink. To view the **Event Investigator** page for the event, click the **ID** hyperlink. For more information about the **Event Investigator** page, see the **Events** manual.
- **Severity**. The severity of the event. Possible values are:
  - *Critical*
  - *Major*
  - *Minor*
  - *Notice*
  - *Healthy*
- **Message**. The message generated for the event. The message appears as a hyperlink. To view the **Event Investigator** page for the event, click the **Message** hyperlink. For more information about the **Event Investigator** page, see the **Events** manual.
- **Age**. The amount of time (in days, hours, and minutes) since the event first occurred or since its last occurrence without having been cleared.
- **Ticket ID**. If a ticket has been created for the event, this column displays the ticket ID of that ticket.
- **Count**. The number of times this event has occurred, the number of child events associated with the event, or the number of masked events associated with the event.
- **Last Detected**. The date and time at which the event last occurred on the device.

- **Ticket External Reference.** The numeric ID associated with a ticket from an external ticketing system (that is, a ticket that was not created in SL1). If this field displays a value, you can click on that value to spawn a new window and view the external ticket.

**NOTE:** To link an external ticket to an event, you must create a custom Run Book Automation policy and a custom Run Book Action or use the ScienceLogic APIs. For help with these tasks, contact ScienceLogic Customer Care.

- **Event Source.** The system or application that generated this event. Possible values are:
  - *Syslog.* Event was generated from a system log generated by a device.
  - *Email.* Event was generated by an email from an external agent. For example, Microsoft Operations Manager (MOM).
  - *Internal.* Event was generated by SL1.
  - *Trap.* Event was generated by an SNMP trap.
  - *Dynamic.* Event was generated by a Dynamic Application collecting data from the device.
  - *API.* Event was generated by a snippet Run Book Action, a snippet Dynamic Application, a request to the ScienceLogic API, or by an external system.
  - *SL1 agent.* Message is generated by log file messages collected by the SL1 agent. For more information about creating Log File Monitoring Policies to monitor log file messages collected by the agent, see the **Monitoring Device Infrastructure Health** manual.
- **Event Note.** A user-defined note to accompany the event. To create or edit a note, click the **Note** icon (  ). The **Edit Event Note** window appears, where you can create or edit a note and save your changes.
- **Acknowledge.** If the event has been acknowledged, this column displays a check mark and the username of the user who acknowledged the event. If the event has not yet been acknowledged, this column displays an **[Acknowledge]** button; click the **[Acknowledge]** button to acknowledge the event. When you **acknowledge** an event, you let other users know that you are aware of that event and are working on a response.
- **Clear.** Click the **[Clear]** button to clear the event. When you **clear** an event, you let other users know that this event has been addressed. Clearing an event removes a single instance of the event from the **[Events]** tab. If the same event occurs again on the same device, it will reappear in the **[Events]** tab, even if you have previously cleared that event.

**TIP:** To rearrange the columns in the List View, click and drag the column name to a new location. You can adjust the width of a column with by clicking and dragging the right edge of the column. You can click the **Select Columns** icon (  ) to add or remove columns, or to reset columns to their default settings.

You can toggle between *Active events* and *Cleared events* by using the drop-down to the left of the **Search** field. On this tab, you can also acknowledge and clear an event if you have permission for those actions.

Clicking the **Actions** menu (  ) next to an event gives you the following options, based on your permissions:

- *View Event*. Navigates to the **Event Investigator** page for that event.
- *Edit Event Note*. Lets you update the Note associated with this event.
- *Edit Ticket*. Opens the Ticket Editor in SL1 if you are using SL1 for your ticketing.
- *Create External Ticket*. Creates a new ticket for the event if you are using an external ticketing system instead of SL1.
- *View Event Policy*. Opens the **Event Policy** page for the policy aligned with this event.
- *Suppress Event for this Device*. Suppresses the current event on the current device. When you suppress an event, you are specifying that in the future, if this event occurs again on the same device, the event will not appear in
- *View Automation Actions*. Displays a log of automations that have occurred for that event. This option is hidden if the event does not have any automation actions aligned to it.

## The Interfaces Tab

On the **[Interfaces]** tab of the **Device Investigator**, you can view information about the various interfaces used by the device, including Port, Hardware Description, MAC Address, Connection Speed, and other details for each interface:

The screenshot shows the 'Interfaces' tab in the Device Investigator interface. The top navigation bar includes 'Report', 'Tools', and 'Edit'. Below the navigation bar, there is a search bar with the text 'Type to search device interfaces'. The main content area displays a table with the following columns: NAME, ALIAS, HARDWARE..., PORT, MACADDRESS..., CONNECTIO..., COLLECTION..., ADMIN STAT..., OPERATION..., COLLECTION..., COLLECT ERR..., COLLECT DIS..., ALERTS, ROLLOVERA..., and INDEX. The table contains one row of data for the interface 'ens32'.

NAME	ALIAS	HARDWARE...	PORT	MACADDRESS...	CONNECTIO...	COLLECTION...	ADMIN STAT...	OPERATION...	COLLECTION...	COLLECT ERR...	COLLECT DIS...	ALERTS	ROLOVERA...	INDEX
ens32	-	ens32	2	00:50:56:85:...	1000000000	Enabled	Up	Up	5	Disabled	Disabled	Enabled	Disabled	2

**NOTE:** For more information about this tab, see the chapter on "Monitoring Network Interfaces" in the *Monitoring Infrastructure Health* manual.

## The Journals Tab

On the **[Journals]** tab of the **Device Investigator**, you can view journal entry information that has been collected from the device by journal Dynamic Applications:

Name	PID	State	Collected On
1 powershell	4548	Open	2020-09-13 16:29:08
2 winrsHost	4276	Open	2020-09-13 16:29:08
3 MyCmdRun	2348	Open	2020-09-13 16:29:08
4 winrsHost	3760	Closed	2020-09-11 04:27:02
5 conHost	4076	Closed	2020-09-11 04:27:02
6 MyCmdRun	1952	Closed	2020-09-11 04:27:01
7 cmd	4468	Closed	2020-09-11 04:27:01
8 conHost	4152	Closed	2020-09-09 06:27:56
9 cmd	4116	Closed	2020-09-09 02:25:53
10 MyCmdRun	4880	Closed	2020-09-09 02:25:53
11 WinMProSE	5076	Closed	2020-09-09 02:25:53
12 powershell	3136	Closed	2020-09-09 02:25:53
13 winrsHost	5068	Open	2020-09-09 02:25:53
14 conHost	4712	Closed	2020-09-09 02:25:53
15 winrsHost	4796	Closed	2020-09-09 02:25:52

**NOTE:** For more information about this tab, see the chapter on "Viewing Configuration & Journal Data" in the *Monitoring Infrastructure Health* manual.

## The Machine Learning Tab

On the [Machine Learning] tab of the Device Investigator, you can view a list of machine learning metrics that are enabled for the device:

METRIC	DATE UPDATED	LAST UPDATED BY	ANOMALY DETECTION
CPU	May 5, 2020, 3:07 PM	em7admin	Enabled
Average Task Time - 0	May 5, 2020, 3:15 PM	em7admin	Enabled
% Storage Used - /var	May 5, 2020, 3:07 PM	em7admin	Enabled
Storage Used - /	May 5, 2020, 2:57 PM	em7admin	Enabled
Activity Log - 0	May 5, 2020, 3:14 PM	em7admin	Enabled

**NOTE:** For more information about machine learning and anomaly detection, see the *Anomaly Detection* manual. For more information about this tab, see the chapter on "Enabling Machine Learning-based Anomaly Detection" in that manual.

## The Map Tab

On the **[Map]** tab in the **Device Investigator**, you can view a map of the selected device and all of the devices with which the device has relationships:

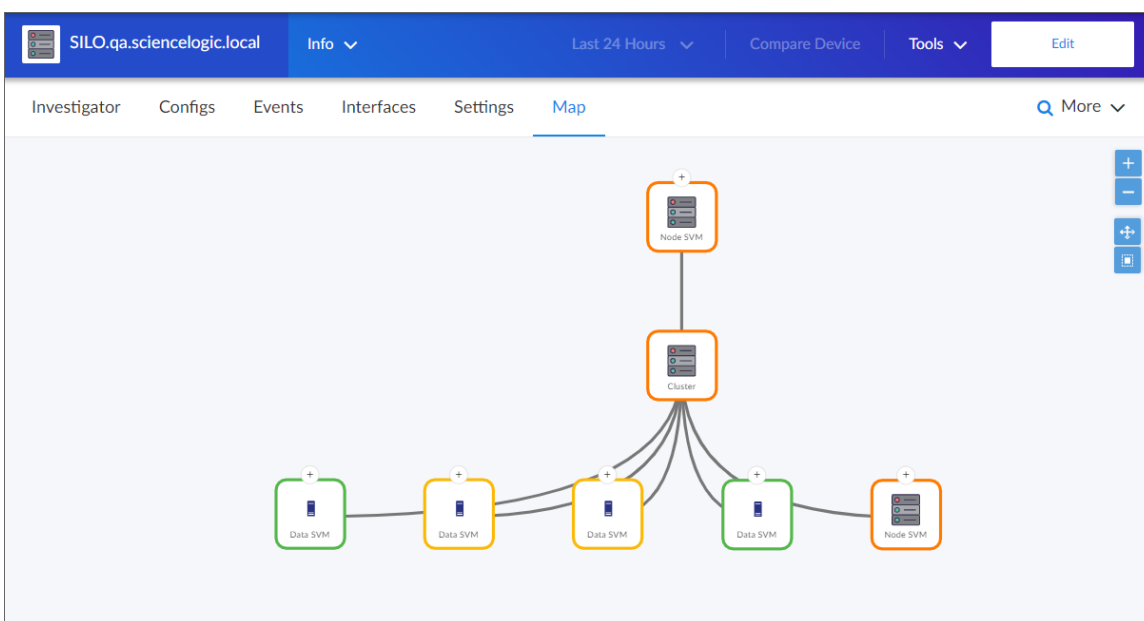

For more information about this tab, see the section on [Viewing Device Topology Maps](#).

For more information about maps, see the *Maps* manual.

## The Monitors Tab

On the **[Monitors]** tab of the **Device Investigator**, you can define monitoring policies for a device.

The **Monitoring Policies** page allows you to define policies that monitor:

- **System processes.** Monitors the device and look for the specified system process.
- **Domain-name availability and lookup speed.** Monitors the availability and lookup time for a specific domain-name server and a specific record on a domain name server.
- **Email round-trip speed.** Monitor the amount of time it takes to send an email message from SL1 to an external mail server and then back to SL1.

- **SOAP and XML transaction speeds.** Monitors any server-to-server transactions that use HTTP and can post files or forms. (for example, SOAP/XML, email, or RSS feeds). Periodically, SL1 sends a request and some data and then examines the result of the transaction and compares it to a specified expression match.
- **TCP/IP port availability.** Monitors ports for availability every 5 minutes. If a port is not available, SL1 creates an event. The data gathered by the port policy is used to create port-availability reports.
- **Web-content availability.** Monitors a website for specific content. SL1 will periodically check the website for specified content. If the content cannot be found on the website, SL1 will generate an event.
- **Windows services.** Monitors the device and look for the specified service.

**NOTE:** All these monitoring policies can generate events. SL1 uses the data collected by these policies to create performance reports and graphs.

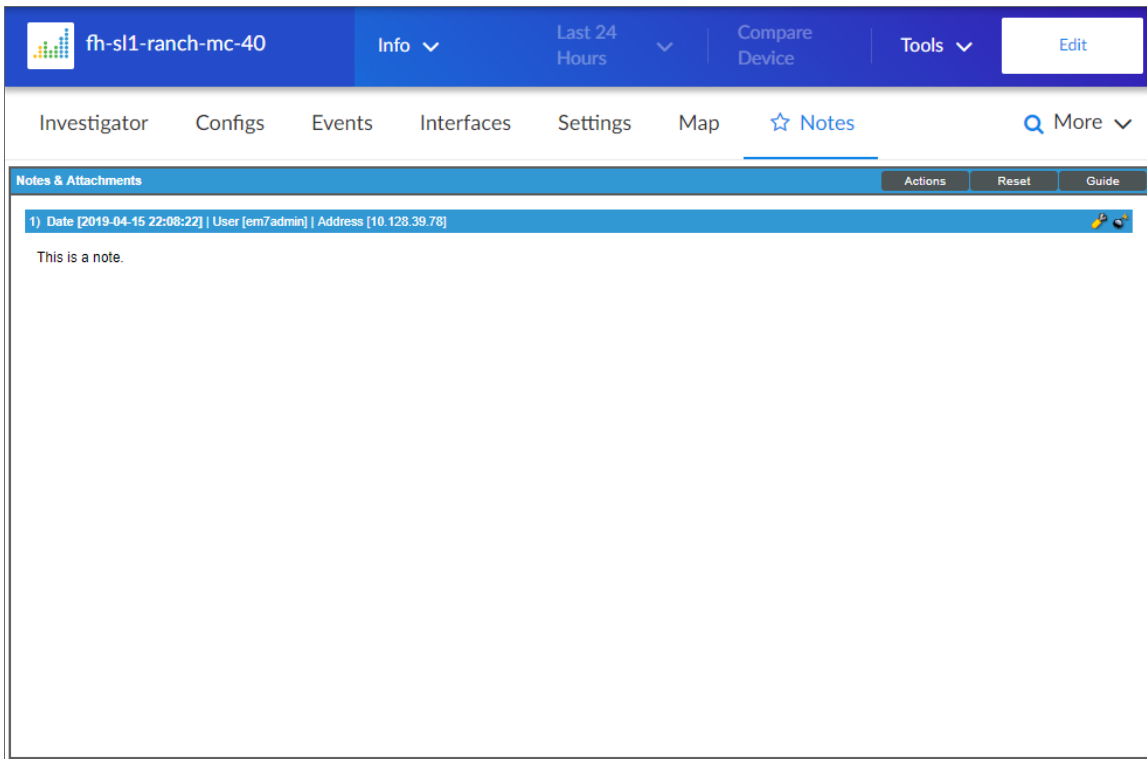

## The Notes Tab

On the **[Notes]** tab of the **Device Investigator**, you can add and view notes and other attachments associated with the device:



To add a note to a device:

1. Go to the **[Notes]** tab of the **Device Investigator**.
2. Click the **[Actions]** button and then select *Notepad Editor*. The **Notepad Editor** modal page appears.

3. In the **Notepad Editor** modal page , you can enter notes or comments about the device.
  - You can format the text and include links, images, and videos in the note.
  - You can also include a document template (System > Customize > Document Templates) in the field.
4. When you are finished adding content to the note, click **[Save]**. The note will appear in the **[Notes]** tab, along with any other notes about the device. Each note includes the username, date and time, and text of the comment. You can perform the following on each note entry:
  - **To view a note's attachment**, click the paperclip icon (  ).
  - **To edit the content of a note**, click the wrench icon (  ). The **Notepad Editor** modal page appears. You can update the note; format the text; insert content from a saved template; and add an attachment, image, or video to the note. Click the **[Save ]** button to save your changes.
  - **To delete a note**, click its bomb icon (  ).

**NOTE:** For information about adding a note to a device in the classic SL1 user interface, see the section on [Adding a Note in the Device Administration Panel](#).

## The Ports Tab

On the **[Ports]** tab of the **Device Investigator**, you can view a list of all open ports on a device:

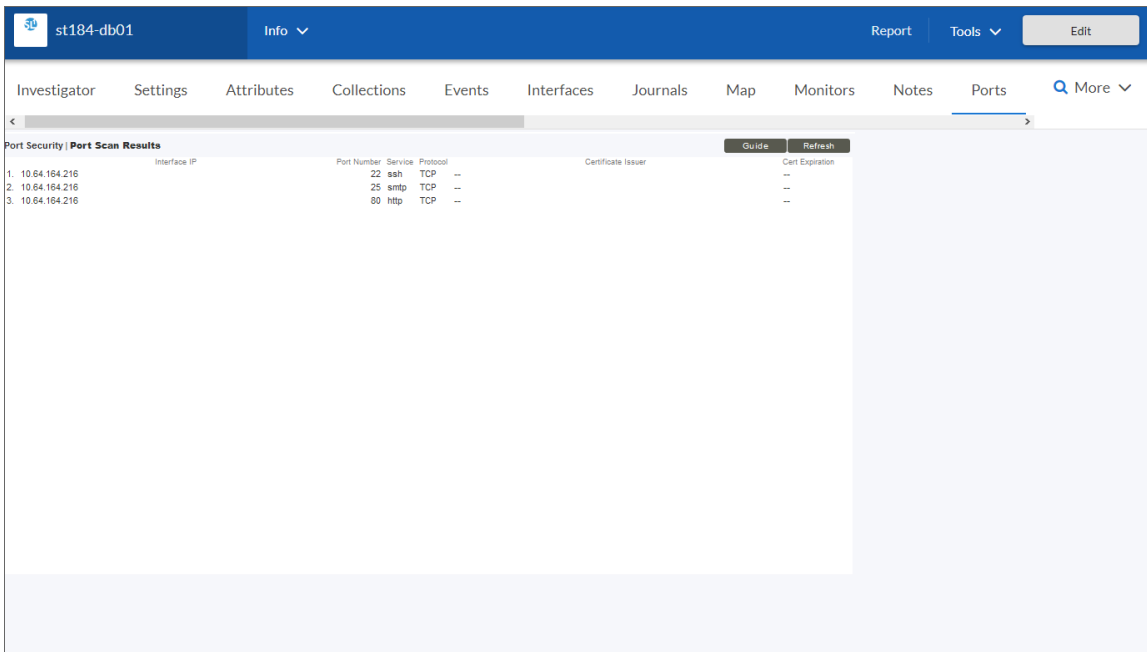



Every night, SL1 scans all the ports of each managed device. If any new ports are opened, SL1 adds the port to the list in the **Port Security** page.

For more information about this tab, see the chapter on "Monitoring Ports" in the *Monitoring Infrastructure Health* manual.

## The Processes Tab

On the **[Processes]** tab of the **Device Investigator**, you can view information about the processes running on the device.

A **process** is a program that is currently running on a monitored device or has been run in the past and is currently idle. Sometimes a process is called a task.

To keep your device running efficiently and to maintain security, the **[Processes]** tab helps you manage processes on your device. The **[Processes]** tab allows you to easily view details about each process running on the device.

## The Redirects Tab

On the **[Redirects]** tab of the **Device Investigator**, you can redirect log entries from one IP-based device to another IP-based device, or from an IP-based device to a virtual device.

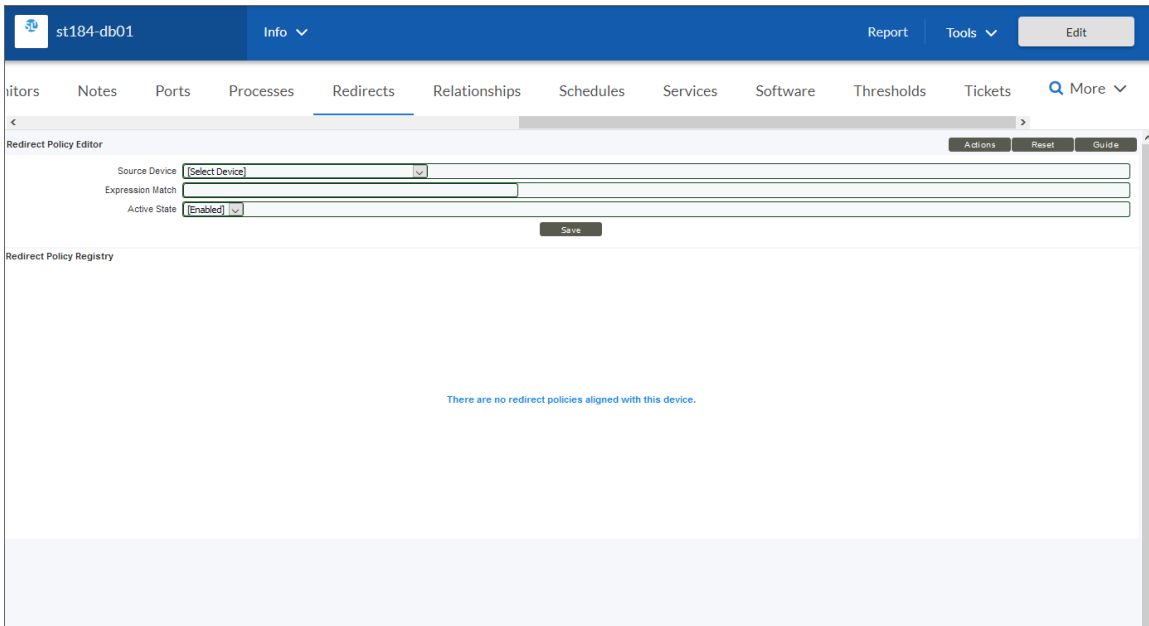

The **[Redirects]** tab allows you to move log entries generated by inbound SNMP Trap, Syslog, or Email messages from one device to another. However, there are a few things to note:

- Log entries that are redirected to a virtual or IP-based device will no longer appear in the log files for the original IP-based device.

- Log entries that are redirected to a virtual or IP-based device are no longer associated with the IP address of the original device.
- Log entries with a **Source** of *Internal*, *Dynamic*, or *API* that match a redirect policy are not moved from the IP-based device to the current device.

To move SNMP Trap, Syslog, or Email log messages from an IP-based device to the current device, provide values in each of the following fields:

- **Source Device**. This is the IP-based device from which you want to redirect log messages. Data from this device will be moved to the virtual or second IP-based device. Select from a drop-down list of all IP-based devices discovered by SL1.
- **Expression Match**. A regular expression used to locate the log entry to redirect. Can be any combination of alphanumeric and multi-byte characters, up to 64 characters in length. SL1's expression matching is case-sensitive. For details on the regular-expression syntax allowed by SL1, see <http://www.python.org/doc/howto/>.
- **Active State**. Specifies whether or not SL1 will execute the redirection policy. The choices are:
  - *Enabled*. SL1 will execute the redirection policy.
  - *Disabled*. SL1 will not execute the redirection policy.

When you are finished, click **[Save]**. You can repeat this process to redirect data to the virtual or IP-based device from more than one device or from more than one type of log message.

## The Relationships Tab

On the **[Relationships]** tab of the **Device Investigator**, you can view information about parent-child relationships between the selected device and other devices.

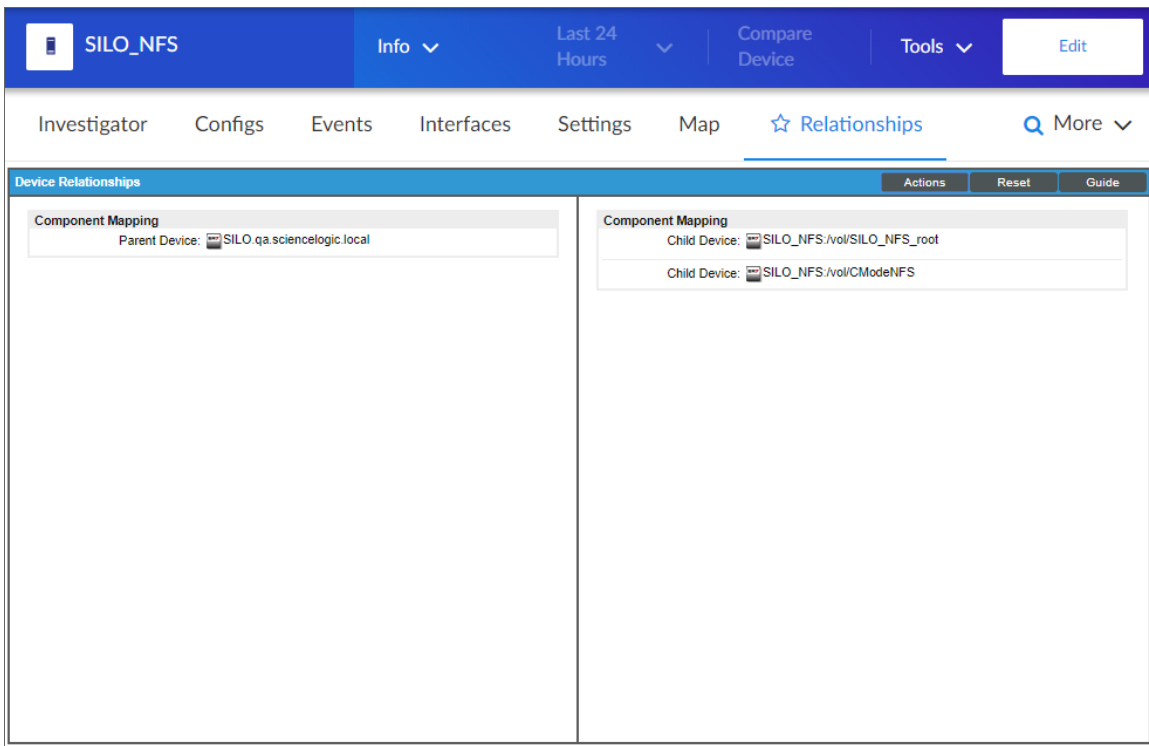

For more information about this tab, see the section on [Viewing Relationships for a Single Device](#).

## The Schedules Tab

On the **[Schedules]** tab of the **Device Investigator**, you can manage all the scheduled process you have defined in your system. You can define scheduled tasks for a number of things, such as backup management, dashboards, devices, and Run Book Automation policies.

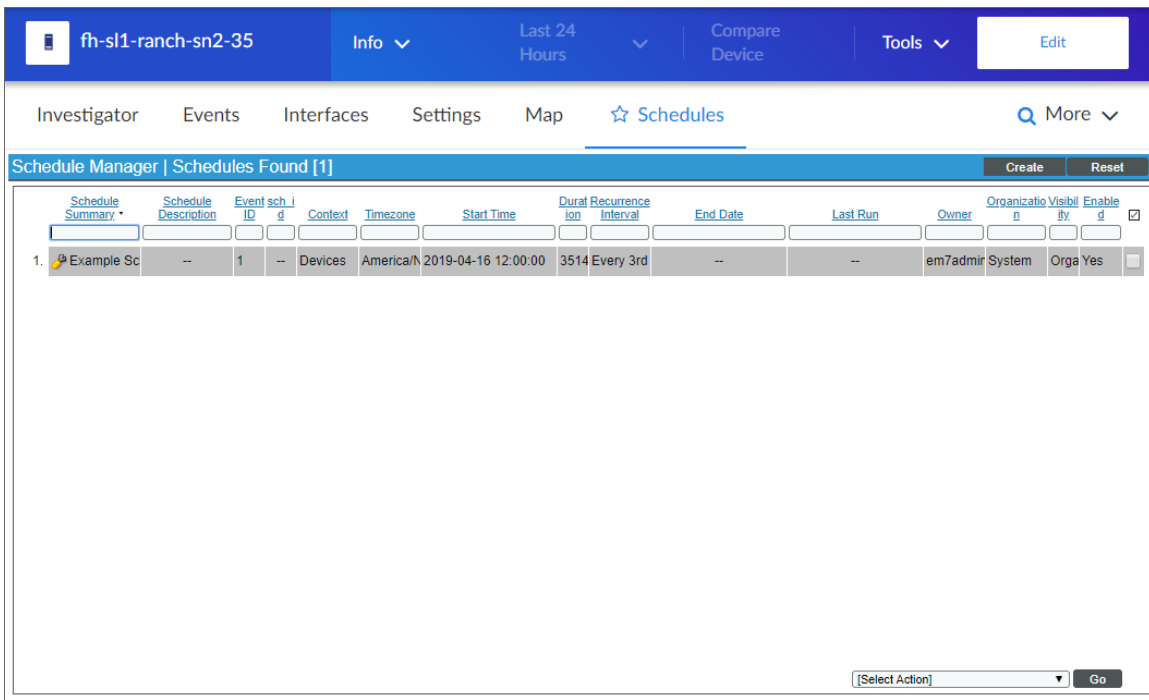

## The Services Tab

On the [Services] tab of the **Device Investigator**, you can view a list of all Windows services enabled on the device:

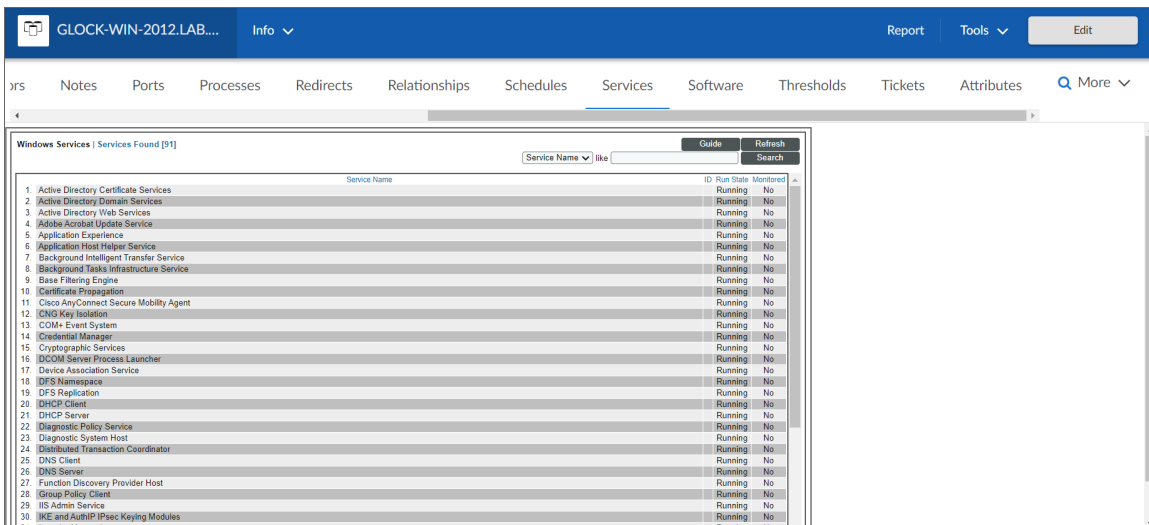

For more information about this tab, see the chapter on "Monitoring Windows Services" in the **Monitoring Infrastructure Health** manual.

## The Software Tab

On the **[Software]** tab of the **Device Investigator**, you can view a list of all the software installed on the device:

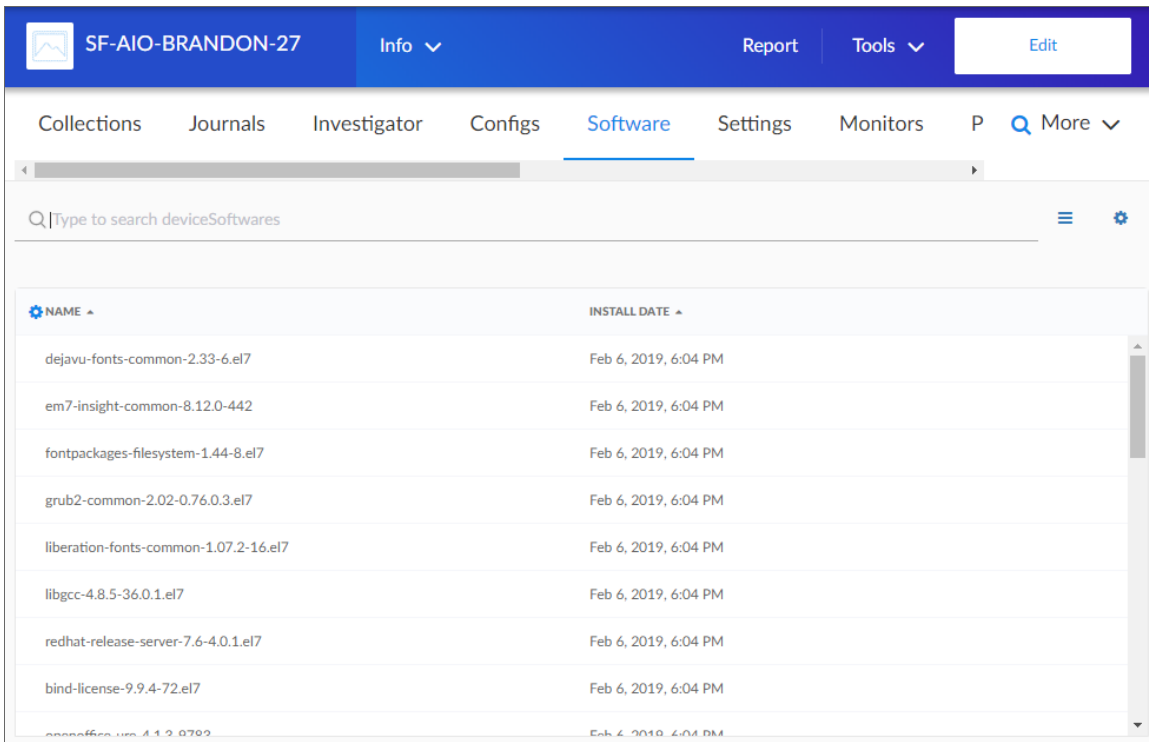

The screenshot shows the 'Software' tab in the Device Investigator interface. The top navigation bar includes 'Info', 'Report', 'Tools', and 'Edit'. Below the navigation bar, there are tabs for 'Collections', 'Journals', 'Investigator', 'Configs', 'Software' (selected), 'Settings', and 'Monitors'. A search bar is present with the placeholder text 'Type to search deviceSoftwares'. The main content area displays a table of installed software packages.

NAME	INSTALL DATE
dejavu-fonts-common-2.33-6.el7	Feb 6, 2019, 6:04 PM
em7-insight-common-8.12.0-442	Feb 6, 2019, 6:04 PM
fontpackages-filesystem-1.44-8.el7	Feb 6, 2019, 6:04 PM
grub2-common-2.02-0.76.0.3.el7	Feb 6, 2019, 6:04 PM
liberation-fonts-common-1.07.2-16.el7	Feb 6, 2019, 6:04 PM
libgcc-4.8.5-36.0.1.el7	Feb 6, 2019, 6:04 PM
redhat-release-server-7.6-4.0.1.el7	Feb 6, 2019, 6:04 PM
bind-license-9.9.4-72.el7	Feb 6, 2019, 6:04 PM
gnomeffice-usr-4.12.0-9792	Feb 6, 2019, 6:04 PM

For more information about this tab, see the chapter on "Monitoring Hardware and Software" in the **Monitoring Infrastructure Health** manual.

## The Thresholds Tab

On the **[Thresholds]** tab of the **Device Investigator**, you can define usage and performance thresholds and data retention thresholds for a device:

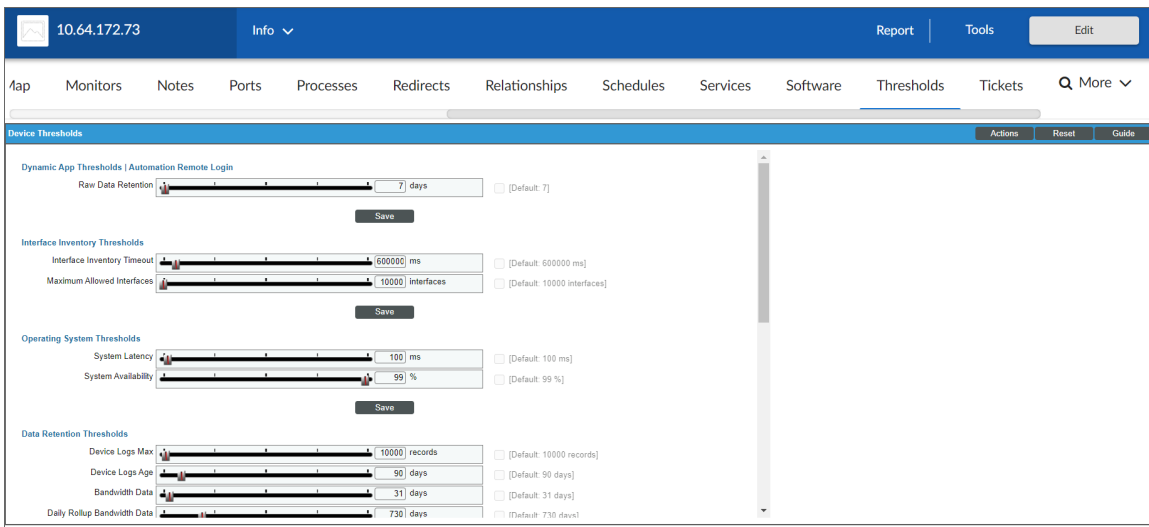



When performance thresholds are exceeded, SL1 will generate an event for the device. When space thresholds are exceeded, SL1 will remove the oldest data from the database. For each of these thresholds, SL1 defines a default value. You can edit the thresholds to meet your needs.

For more information about this tab, see the section on [Device Thresholds](#).

## The Tickets Tab

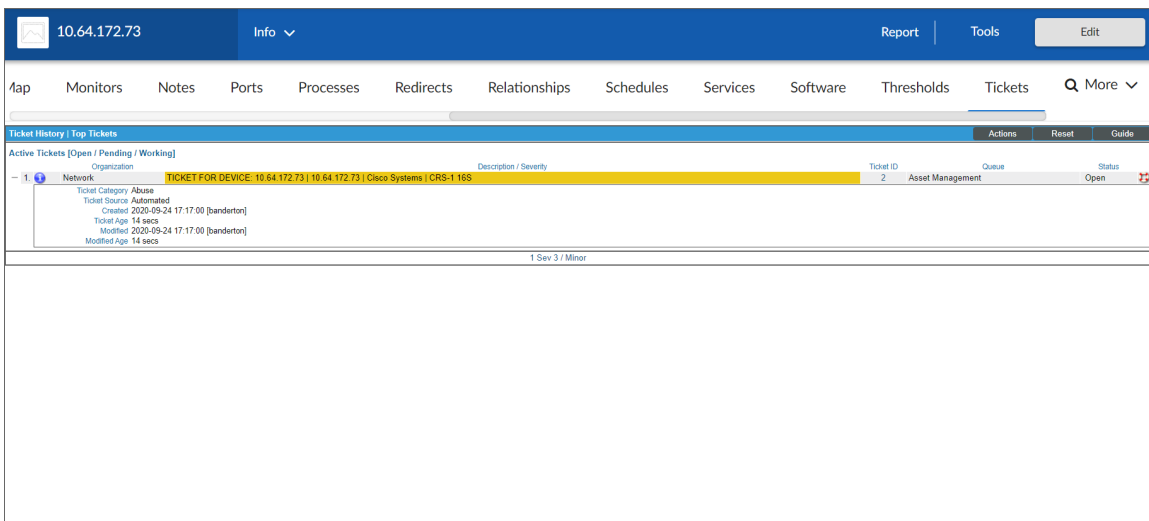
On the **[Tickets]** tab of the **Device Investigator**, you can view all tickets associated with the device and create new tickets to associate with the device:



The **[Tickets]** tab displays critical information about each ticket. If you require more detail, you can access the **Ticket Editor** from this page by clicking on the ticketing icon (  ).

You can also create a new ticket from this page.

To create a new ticket for a device:

1. Go to the **[Tickets]** tab of the **Device Investigator**.
2. Click the **[Actions]** button and then select *Create a Ticket*. The **Ticket Editor** page appears.
3. On the **Ticket Editor** page that appears, define the basic parameters for the ticket. For information about the fields on this page, see the chapter on "Creating and Editing Tickets" in the ***Ticketing*** manual.

**NOTE:** The **Description** and **Element** fields are automatically populated with information about the device.

4. When you are finished, click **[Save]**.

**NOTE:** For information about creating a ticket for a device in the classic SL1 user interface, see the section on [Creating a Ticket About a Device](#).

## Using the Device Manager Page



---

### Overview

After running discovery for the first time, you can view the list of discovered devices on the **Device Manager** page (Devices > Device Manager).

**NOTE:** The list of devices on the **Device Manager** page matches the list of devices on the **Devices** page, but the **Device Manager** page includes additional functionality, which will be covered in this chapter.

Use the following menu options to navigate the SL1 user interface:

- To view a pop-out list of menu options, click the menu icon (.
- To view a page containing all of the menu options, click the Advanced menu icon (.

This chapter includes the following topics:

<b>Viewing the List of All Devices</b> .....	<b>57</b>
<i>Device Manager Preferences</i> .....	60
<i>Filtering the List of Devices</i> .....	60
<i>Special Characters</i> .....	62
<i>Using the Advanced Filter with the List of Devices</i> .....	65
<b>Generating a Report for Multiple Devices</b> .....	<b>67</b>
<b>Generating a Report for a Single Device</b> .....	<b>69</b>
<b>Viewing the List of Component Devices</b> .....	<b>71</b>
<i>Availability for Component Devices</i> .....	74



Viewing Children Devices .....	75
Filtering the List of Component Devices .....	75
Using the Advanced Filter with the List of Component Devices .....	76
<b>Bulk Actions in the Device Management Page .....</b>	<b>78</b>
<b>Bulk Actions for Component Devices .....</b>	<b>79</b>
<b>Bulk Merging and Unmerging of Devices .....</b>	<b>81</b>
Performing a Bulk Device Merge .....	82
Performing a Bulk Device Unmerge .....	84

## Viewing the List of All Devices

After running discovery for the first time, you can view the list of discovered devices in the **Device Manager** page. To access the **Device Manager** page, go to Devices > Device Manager (or Registry > Devices > Device Manager in the classic user interface):

Device Name	IP Address	Device Category	Device Class   Sub-class	DID	Organization	Current Status	Collection Status	Collection Error	SNMP Credentials	SNMP Version	SL Agent
10-64-171-130-CDB	10.64.171.130	System:EM7	ScienceLogic, Inc.   EM7 Database	1	System	Minor	CUJG	Active	EM7 Default V2	V2	No
78009-NPE3-cisco.com	10.20.7.31	Network.Router	Cisco Systems   78009	2	System	Minor	CUJG	Active	Cisco SNMPv2 - EV2	EV2	No
AA-AIO-33-177	192.168.33.177	System:EM7	ScienceLogic, Inc.   EM7 All-in-One	13	System	Critical	CUJG	Active	EM7 Default V3	V3	No
asupekar-aioc-92	10.2.15.92	System:EM7	ScienceLogic, Inc.   EM7 All-in-One	20	System	Minor	CUJG	Active	EM7 Default V2	V2	No
Automation-system1-110	10.2.15.110	System:EM7	ScienceLogic, Inc.   EM7 All-in-One	72	System	Minor	CUJG	Unavailable	EM7 Default V2	V2	No
Automation_GM_Sc_10215111	10.2.15.111	System:EM7	ScienceLogic, Inc.   EM7 All-in-One	73	System	Minor	CUJG	Unavailable	EM7 Default V2	V2	No
ayoung-dist-ou-251	127.0.0.1	System:EM7	ScienceLogic, Inc.   EM7 Data Collector	88	System	Minor	CUJG	Active	EM7 Default V3	V3	No
CB-8.4AIO.33.205	192.168.33.205	System:EM7	ScienceLogic, Inc.   EM7 All-in-One	25	System	Minor	CUJG	Active	EM7 Default V3	V3	No
CB-8.5AIO.33.204	192.168.33.204	System:EM7	ScienceLogic, Inc.   EM7 All-in-One	24	System	Minor	CUJG	Active	EM7 Default V3	V3	No
cg-aioc	192.168.33.101	System:EM7	ScienceLogic, Inc.   EM7 All-in-One	8	System	Minor	CUJG	Active	EM7 Default V3	V3	No
CUJCM10-01.qa.scienceologic.local	10.0.13.20	UC Device	Cisco Systems   CUJCM Server	3	System	Minor	CUJG	Active	SNMP Public V2	V2	No
DB1	192.168.33.211	System:EM7	ScienceLogic, Inc.   EM7 Database	23	System	Minor	CUJG	Unavailable	EM7 Default V3	V3	No
DB2	192.168.33.222	System:EM7	ScienceLogic, Inc.   EM7 Database	41	System	Minor	CUJG	Unavailable	EM7 Default V3	V3	No
EM7-HADR-CUJG	192.168.33.147	System:EM7	ScienceLogic, Inc.   EM7 Data Collector	88	System	Minor	CUJG	Active	EM7 Default V3	V3	No
em7-hadr-db1	192.168.33.141	System:EM7	ScienceLogic, Inc.   EM7 Database	84	System	Minor	CUJG	Active	EM7 Default V3	V3	No
em7-hadr-db2	192.168.33.146	System:EM7	ScienceLogic, Inc.   EM7 Database	85	System	Minor	CUJG	Active	EM7 Default V3	V3	No
em7taio	192.168.33.180	System:EM7	ScienceLogic, Inc.   EM7 All-in-One	10	System	Critical	CUJG	Active	EM7 Default V3	V3	No
em7taoc	10.64.60.16	System:EM7	ScienceLogic, Inc.   EM7 All-in-One	87	System	Minor	CUJG	Active	EM7 Default V3	V3	No
garydb990	192.168.33.129	System:EM7	ScienceLogic, Inc.   EM7 Database	81	System	Minor	CUJG	Active	EM7 Default V3	V3	No
gmstacd01	10.2.15.100	System:EM7	ScienceLogic, Inc.   EM7 All-in-One	60	West Coast	Minor	CUJG	Unavailable	EM7 Default V2	V2	No
gmstacd02	10.2.15.101	System:EM7	ScienceLogic, Inc.   EM7 All-in-One	50	East Coast	Minor	CUJG	Unavailable	EM7 Default V2	V2	No
gmstacd03	10.2.15.102	System:EM7	ScienceLogic, Inc.   EM7 All-in-One	62	System	Minor	CUJG	Unavailable	EM7 Default V2	V2	No
gmstacd04	10.2.15.103	System:EM7	ScienceLogic, Inc.   EM7 All-in-One	61	System	Minor	CUJG	Unavailable	EM7 Default V2	V2	No
gmstacd05	10.2.15.104	System:EM7	ScienceLogic, Inc.   EM7 All-in-One	63	System	Minor	CUJG	Unavailable	EM7 Default V2	V2	No

The **Device Manager** page displays the following information about each device:

**TIP:** To sort the list of devices, click on a column heading. The list will be sorted by the column value, in ascending order. To sort the list by descending order, click the column heading again.









- **Device Name.** Name of the device. For devices running SNMP or with DNS entries, the name is discovered automatically. For devices without SNMP or DNS entries, the device's IP address will appear in this field.
- **Device Hostname.** For devices that are discovered and managed by hostname (instead of IP address), this field displays the fully qualified hostname for the device.
- **IP Address.** The IP address of the device.

- **Device Category.** The category assigned to the device. Categories include servers, routers, switches, firewalls, and printers, among others. The category is automatically assigned during discovery, at the same time as the as Device Class/Sub-Class.
- **Device Class/Device Sub-Class.** The manufacturer (device class) and type of device (sub-class). The Device Class/Sub-Class is automatically assigned during discovery, at the same time as the Category.
- **DID.** Device ID. This is a unique number automatically assigned to the device by SL1 .
- **Organization.** The Organization to which the device is assigned.
- **Current State.** Condition of the device, based upon events generated by the device. Condition can be one of the following:
  - *Critical.* Device has a serious problem that requires immediate attention.
  - *Major.* Device has a problem that requires immediate attention.
  - *Minor.* Device has a less-serious problem.
  - *Notice.* Device has an informational event associated with it.
  - *Healthy.* Device is running with no problems.

**NOTE:** The appearance of the **Current State** field depends upon value in the **Show Severity Badges** field in your user preferences. If the **Show Severity Badges** field is enabled, the value in the **Current State** column will be displayed as a color-coded badge. If the **Show Severity Badges** field is not enabled, the value in the **Device Name** column and the value in the **Current State** column will be painted with the severity color.

- **Collection Group.** Specifies the collector group to which the device belongs. Collector Groups are defined in the **Collector Group Management** page (System > Settings > Collector Groups) and specify a primary Data Collector and an optional failover collector. A Data Collector server is the appliance that gathers data from the device. For All-In-One Appliances, this field displays only the built-in Collector Group (and any virtual Collector Groups).
- **Collection State.** Collection state can be one of the following:
  - *Active.* SL1 is collecting data from the device.
  - *Unavailable.* SL1 cannot connect to the device, and will not collect data from the device until the device becomes available.
  - *Disabled.* SL1 is not currently collecting data from the device.
  - *Component Vanished.* The component device has vanished, i.e. is not currently being reported by its root device. SL1 cannot collect data from the device at this time.
- **SNMP Credential.** Primary credential used by SL1 to retrieve SNMP information about the device.

**NOTE:** Your organization membership(s) might affect the display in the **SNMP Credential** column. For details, see the **Discovery and Credentials** manual.

- **SNMP Version.** The version of SNMP used by the **SNMP Credential**.
- **SL Agent.** Indicates if the SL1 agent is installed on the device. If the agent is installed on the device, see SL Agent column displays a gear icon that can be used to access agent settings. For more information about editing Agent settings, see the **Monitoring Using the Agent** manual. The **SL Agent** column does not appear on the **Device Manager** page by default. For more information about adding or removing columns on the **Device Manager** page, see the **Device Manager Preferences** section.
- **Tools.** Displays icons for managing devices. The choices are:
  - **Device Administration** (). Leads to the **Device Properties** page, where you can define basic device parameters and parameters for discovery. From the **Device Properties** page, you can also access the other pages in the **Device Administration** tools.
  - **Device Management** (). Leads to the **Device Summary** page, where you can see reports and logs related to the device. From the **Device Summary** page, you can also access the other pages in the **Device Reports** panel. For details on Device Reports, see the manual **Monitoring Device Infrastructure Health**.
  - **Root Device** (). Indicates that the device is a **component device**. Leads to the **Device Properties** page of the root device for the component device. In SL1, the **root device** is the physical device that hosts the system that manages the component device.
  - **Parent Device** (). Indicates that the device is a **component device**. Leads to the **Device Properties** page of the parent device for the component device. In SL1, the **parent device** can be either another component device or a physical device. A parent device can be either: a the component device between the current component device and the next layer in the component-device hierarchy or a root device.
  - **Interfaces** (). Leads to the **Interfaces Found** page, where you can view details about each network interface on the device. For details on device interfaces, see the **Device Management** manual.
  - **Print Report** (). Generates a report for the selected icon. Spawns the **Report Selector** page, where you can specify the information to include in the report (Full Report, Status, Config, Hardware, Notes, Software, Processes, Network, Events, and Health) and the format in which the report will be generated (Create Report as HTML Document, Create Report as PDF Document, Create Report as MS Word Document, or Create Report as MS Excel Document).
  - **Create Ticket** (). Leads to the **Ticket Editor** page, where you can define and file a new ticket for the device. For details on creating tickets, see the manual **Ticketing**.
  - **View Asset Record** (). This icon appears if an asset record has already been defined for the device. This icon leads to the **Asset Properties** page, where you can view the asset record for the device.
  - **Create Asset Record** (). This icon appears if an asset record has not been defined for the device. This icon leads to the **Asset Properties** page, where you can create an asset record for the device.
  - **Checkbox** (). Applies the action in the **Select Action** drop-down to the device. To select all checkboxes (i.e., to select all devices), select the large red check icon.

## Device Manager Preferences

The **Device Manager Preferences** page allows you to customize the display and behavior of the **Device Manager** page. To access this page, go to the **Device Manager** page, select the **[Actions]** menu, and then choose *Device Manager Preferences*.

In the **Device Manager Preferences** page, you can customize the following:

- **Device Manager Columns.** In this list, you can select the default columns to be displayed in the **Device Manager** page.

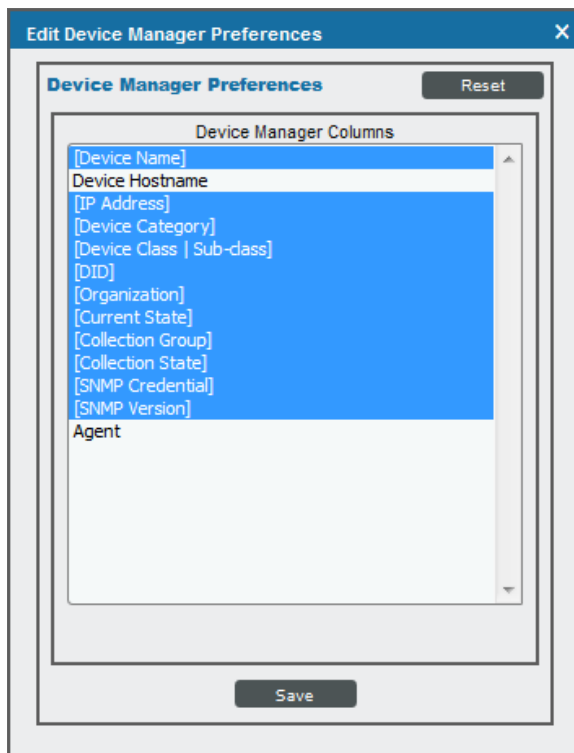

**NOTE:** When you edit the list of columns in the **Device Manager Columns** field, the selected list of columns in the **Account Preferences** page is automatically updated. When you edit the list of columns in the **Account Preferences** page, the selected list of columns in this page is updated.

## Filtering the List of Devices

You can filter the list on the **Device Manager** page by one or more parameters. Only devices that meet all the filter criteria will be displayed in the **Device Manager** page.

To filter by each parameter except **Current State**, enter text into the desired filter-while-you-type field. The **Device Manager** page searches for devices that match the text, including partial matches. By default, the cursor is placed in the left-most filter-while-you-type field. You can use the <Tab> key or your mouse to move your cursor through the fields. The list of devices is dynamically updated as you type. Text matches are not case-sensitive.

You can also use special characters to filter each parameter.

Filter the list by one or more of the following parameters:

- **Device Name**. You can enter text to match, including special characters, and the **Device Manager** page will display only devices that have a matching device name.
- **Device Hostname**. You can enter text to match, including special characters, and the **Device Manager** page will display only devices that have a matching hostname.
- **IP Address**. You can enter text to match, including special characters, and the **Device Manager** page will display only devices that have a matching IP address.
- **Device Category**. You can enter text to match, including special characters, and the **Device Manager** page will display only devices that have a matching device category.
- **Device Class**. You can enter text to match, including special characters, and the **Device Manager** page will display only devices that have a matching device class.
- **DID**. You can enter text to match, including special characters, and the **Device Manager** page will display only devices that have a matching device ID.
- **Organization**. You can enter text to match, including special characters, and the **Device Manager** page will display only devices that have a matching organization.
- **Current State >=**. Specifies the device's current state. Only those devices that match all the previously selected fields and have the specified condition will be displayed. A device's condition is determined by its most severe, outstanding event. The choices are:
  - **>=Healthy**. Include devices with a condition of "Healthy" or greater. This will include all devices.
  - **>=Notice**. Include devices with a condition of "Notice" or greater. This means, include devices with a condition of "Notice", "Minor", "Major", and "Critical".
  - **>=Minor**. Include devices with a condition of "Minor" or greater. This means, include devices with a condition of "Minor", "Major", and "Critical".
  - **>=Major**. Include devices with a condition of "Major" or greater. This means, include devices with a condition of "Major" and "Critical".
  - **>=Critical**. Include devices with a condition of "Critical" or greater. This means, include devices with a condition of "Critical", because there is no "greater" condition.
- **Collection Group**. You can enter text to match, including special characters, and the **Device Manager** page will display only devices that have a matching Collector Group.
- **Collection State**. You can enter text to match, including special characters, and the **Device Manager** page will display only devices that have a matching Collection State.
- **SNMP Credential**. You can enter text to match, including special characters, and the **Device Manager** page will display only devices that have a matching SNMP credential.

- **SNMP Version.** You can enter text to match, including special characters, and the **Device Manager** page will display only devices that have a matching SNMP version.

**TIP:** To return to the default list of events, select the **[Reset]** button.

## Special Characters

You can include the following special characters to filter by each column except those that display date and time:

**NOTE:** When searching for a string, SL1 will match substrings by default, even if you do not include any special characters. For example, searching for "hel" will match both "hello" and "helicopter". When searching for a numeric value, SL1 will not match a substring unless you use a special character.

### String and Numeric

- , (comma). Specifies an "OR" operation. Works for string and numeric values. For example:  
"dell, micro" matches all values that contain the string "dell" OR the string "micro".
- & (ampersand). Specifies an "AND" operation. Works for string and numeric values. For example:  
"dell & micro" matches all values that contain both the string "dell" AND the string "micro", in any order.
- ! (exclamation point). Specifies a "not" operation. Works for string and numeric values. For example:  
"!dell" matches all values that do not contain the string "dell".  
"! ^ micro" would match all values that do not start with "micro".  
"!fer\$" would match all values that do not end with "fer".  
"! ^ \$" would match all values that are not null.  
"! ^" would match null values.  
"!\$" would match null values.  
"!\*" would match null values.  
"happy, !dell" would match values that contain "happy" OR values that do not contain "dell".

**NOTE:** You can also use the "!" character in combination with the arithmetic special characters (min-max, >, <, >=, <=, =) described below.

- \* (asterisk). Specifies a "match zero or more" operation. Works for string and numeric values. For a string, matches any string that matches the text before and after the asterisk. For a number, matches any number that contains the text. For example:

"hel\*er" would match "helpers" and "helicopter" but not "hello".

"325\*" would match "325", "32561", and "325000".

"\*000" would match "1000", "25000", and "10500000".

- ? (question mark). Specifies "match any one character". Works for string and numeric values. For example:

"l?ver" would match the strings "oliver", "levers", and "lover", but not "believer".

"135?" would match the numbers "1350", "1354", and "1359", but not "135" or "13502"

### String

- ^ (caret). For strings only. Specifies "match the beginning". Matches any string that begins with the specified string. For example:

"^sci" would match "scientific" and "sciencelogic", but not "conscious".

"^happy\$" would match only the string "happy", with no characters before or after.

"!^micro" would match all values that do not start with "micro".

"!^\$" would match all values that are not null.

"!^" would match null values.

- \$ (dollar sign). For strings only. Specifies "match the ending". Matches any string that ends with the specified string. For example:

"ter\$" would match the string "renter" but not the string "terrific".

"^happy\$" would match only the string "happy", with no characters before or after.

"!fer\$" would match all values that do not end with "fer".

"!^\$" would match all values that are not null.

"!\$" would match null values.

**NOTE:** You can use both ^ and \$ if you want to match an entire string and only that string. For example, "^tern\$" would match the strings "tern" or "Tern" or "TERN"; it would not match the strings "terne" or "cistern".

## Numeric

- min-max. Matches numeric values only. Specifies any value between the minimum value and the maximum value, including the minimum and the maximum. For example:

"1-5" would match 1, 2, 3, 4, and 5.

- - (dash). Matches numeric values only. A "half open" range. Specifies values including the minimum and greater or including the maximum and lesser. For example:

"1-" matches 1 and greater. So would match 1, 2, 6, 345, etc.

"-5" matches 5 and less. So would match 5, 3, 1, 0, etc.

- > (greater than). Matches numeric values only. Specifies any value "greater than". For example:

">7" would match all values greater than 7.

- < (less than). Matches numeric values only. Specifies any value "less than". For example:

"<12" would match all values less than 12.

- >= (greater than or equal to). Matches numeric values only. Specifies any value "greater than or equal to". For example:

">=7" would match all values 7 and greater.

- <= (less than or equal to). Matches numeric values only. Specifies any value "less than or equal to". For example:

"<=12" would match all values 12 and less.

- = (equal). Matches numeric values only. For numeric values, allows you to match a negative value. For example:

"=-5" would match "-5" instead of being evaluated as the "half open range" as described above.

## Additional Examples

- "aio\$". Matches only text that ends with "aio".
- "^shu". Matches only text that begins with "shu".
- "^silo\$". Matches only the text "silo", with no characters before or after.
- "!silo". Matches only text that does not contain the characters "silo".
- "!^silo". Matches only text that does not start with "silo".
- "!O\$". Matches only text that does not end with "O".
- "!^silo\$". Matches only text that is not the exact text "silo", with no characters before or after.
- "!. Matches null values, typically represented as "--" in most pages.
- "!. Matches null values, typically represented as "--" in most pages.



- "!"^\$". Matches all text that is not null.
- "silo, !aggr". Matches text that contains the characters "silo" and also text that does not contain "aggr".
- "silo, 02, !aggr". Matches text that contains "silo" and also text that contains "02" and also text that does not contain "aggr".
- "silo, 02, !aggr, !01". Matches text that contains "silo" and also text that contains "02" and also text that does not contain "aggr" and also text that does not contain "01".
- "^s\*i!\*o\$". Matches text that contains the letter "s", "i", "l", "o", in that order. Other letters might lie between these letters. For example "sXiXo" would match.
- "!^s\*i!\*o\$". Matches all text that does not that contains the letter "s", "i", "l", "o", in that order. Other letters might lie between these letters. For example "sXiXo" would not match.
- "!vol&!silo". Matches text that does not contain "vol" AND also does not contain "silo". For example, "volume" would match, because it contains "vol" but not "silo".
- "!vol&02". Matches text that does not contain "vol" AND also contains "02". For example, "happy02" would match, because it does not contain "vol" and it does contain "02".
- "aggr, !vol&02". Matches text that contains "aggr" OR text that does not contain "vol" AND also contains "02".
- "aggr, !vol&!infra". Matches text that contains "aggr" OR text that does not contain "vol" AND does not contain "infra".
- "\*". Matches all text.
- "!\*". Matches null values, typically represented as "--" in most pages.
- "silo". Matches text that contains "silo".
- "!silo". Matches text that does not contain "silo".
- "!^silo\$". Matches all text except the text "silo", with no characters before or after.
- "-3,7-8,11,24,50-". Matches numbers 1, 2, 3, 7, 8, 11, 24, 50, and all numbers greater than 50.
- "-3,7-8,11,24,50-,a". Matches numbers 1, 2, 3, 7, 8, 11, 24, 50, and all numbers greater than 50, and text that includes "a".
- "?n". Matches text that contains any single character and the character "n". For example, this string would match "an", "bn", "cn", "1n", and "2n".
- "n\*SAN". Matches text the contains "n", zero or any number of any characters and then "SAN". For example, the string would match "nSAN", and "nhamburgerSAN".
- "^?n\*SAN\$". Matches text that begins with any single character, is following by "n", and then zero or any number of any characters, and ends in "SAN".

## Using the Advanced Filter with the List of Devices

In the **Device Manager** page, you can specify one or more parameters to filter the display of devices. Only devices that meet all the filter criteria will be displayed.

The Advanced Filter Tool allows you to make selections instead of manually typing in a string to filter on.

**TIP:** To select multiple entries in the Advanced Filter Tool, hold down the <Ctrl> key and left-click the entries.

After selecting all filters, select the **[Apply]** button to apply the filters to the list of devices.

To reset each field and apply no filters, select the **[Reset]** button.

To access the Advanced Filter Tool:

1. Go to the **Device Manager** page.
2. Click on the funnel icon (  ).
3. The Advanced Filter Tool will display advanced filters for each column in the page.

**NOTE:** Unlike the "find while you type" feature, the Advanced Filter Tool is not applied to the list of devices until you select the **[Apply]** button.

4. In the Advanced Filter Tool, you can filter by one or more of the following filters.
  - **Device Name.** In the *Match Any* fields, you can enter one or more text strings to match, including special characters. The **Device Manager** page will display only devices that have a matching device name.
  - **Device Hostname.** In the *Match Any* fields, you can enter one or more text strings to match, including special characters. The **Device Manager** page will display only devices that have a matching hostname.
  - **IP Address.** In the *Match Any* fields, you can enter one or more text strings to match, including special characters. The **Device Manager** page will display only devices that have a matching IP address.
  - **Device Category.** Select from a list of device categories that have member devices. The **Device Manager** page will display only devices that have a matching device category.
  - **Device Class | Sub-class.** In the *Match Any* fields, you can enter one or more text strings to match, including special characters. The **Device Manager** page will display only devices that have a matching device class or sub-class.
  - **DID.** In the *From* and *To* field, you can specify a range of device IDs. The **Device Manager** page will display only devices that fall within that range of device IDs.
  - **Organization.** Select from a list of organizations that have member devices. The **Device Manager** page will display only devices that have a matching organization.
  - **Current State.** You can select from a list of device states. The **Device Manager** page will display only devices that have a matching state.
  - **Collection Group.** Select from a list of collection groups that have member devices. The **Device Manager** page will display only devices that have a matching collection group.

- **Collection State.** Select from a list of collection states that have member devices. The **Device Manager** page will display only devices that have a matching collection state.
- **SNMP Credential.** Select from a list of SNMP credentials that have member devices. The **Device Manager** page will display only devices that have a matching SNMP credential.
- **SNMP Version.** Select from a list of SNMP versions that have member devices. The **Device Manager** page will display only devices that have a matching SNMP version.
- **SL Agent.** Select either Yes or No. Yes indicates that the agent is installed on the device. No indicates that the agent is not installed on the device. The **Device Management** page will display only devices that either have or do not have the agent installed.

5. After selecting all filters, select the **[Apply]** button to apply the filters to the list of devices.
6. To reset each field and apply no filters, select the **[Reset]** button.

**TIP:** You can perform an advanced filter and then perform a second advanced filter on the results of the first advanced filter. You can continue to modify and apply an advanced filter multiple times.

## Generating a Report for Multiple Devices

From the **Device Manager** page (Devices > Device Manager), you can generate a report on all devices in SL1 or on multiple devices in SL1. The report will be in .xlsx format and will contain all the information displayed in the **Device Manager** page.

Device Manager Report generated by banderton on 2015-04-17 03:51:54

	Device Name	IP Address	Device Category	Device Class	Sub-class	DID	Organization	State	Col Group	Collection	SNMP Credential	SNMP Version
0	ivolresboot01blankun.lun		Storage.LUN	NetApp	LUN C-Mode	12977	SILO	Healthy	CUG	Unavailable	SNMP Public V2	V2
1	ivolresboot01_B2_esxi		Storage.LUN	NetApp	LUN C-Mode	12975	SILO	Healthy	CUG	Unavailable	SNMP Public V2	V2
2	ivolresboot01_B3_esxi		Storage.LUN	NetApp	LUN C-Mode	12987	SILO	Healthy	CUG	Unavailable	SNMP Public V2	V2
3	ivolresboot02_B5_esxi		Storage.LUN	NetApp	LUN C-Mode	12970	SILO	Healthy	CUG	Unavailable	SNMP Public V2	V2
4	ivolresboot02_B6_esxi		Storage.LUN	NetApp	LUN C-Mode	12972	SILO	Healthy	CUG	Unavailable	SNMP Public V2	V2
5	ivolresboot02_B7_esxi		Storage.LUN	NetApp	LUN C-Mode	12976	SILO	Healthy	CUG	Unavailable	SNMP Public V2	V2
6	ivolresboot02_S1_esxi		Storage.LUN	NetApp	LUN C-Mode	12973	SILO	Healthy	CUG	Unavailable	SNMP Public V2	V2
7	ivolresxi_shared_dsShared_DS		Storage.LUN	NetApp	LUN C-Mode	12962	SILO	Healthy	CUG	Unavailable	SNMP Public V2	V2
8	ivolresxi_shared_dsShared_DS_clone	040314_163750	Storage.LUN	NetApp	LUN C-Mode	12960	SILO	Healthy	CUG	Unavailable	SNMP Public V2	V2
9	ivolresxi_shared_dsVDR_Lun		Storage.LUN	NetApp	LUN C-Mode	12958	SILO	Healthy	CUG	Unavailable	SNMP Public V2	V2
10	ivolresxi_shared_lun_volresxi_shared_lun		Storage.LUN	NetApp	LUN C-Mode	12961	SILO	Healthy	CUG	Unavailable	SNMP Public V2	V2
11	ivolHA_SANha_san.lun		Storage.LUN	NetApp	LUN C-Mode	12978	SILO	Healthy	CUG	Unavailable	SNMP Public V2	V2
12	ivolresxi_shared_2_ds_volresxi_shared_2_ds		Storage.LUN	NetApp	LUN C-Mode	12965	SILO	Healthy	CUG	Unavailable	SNMP Public V2	V2
13	ivolresxi/flexc1.lun		Storage.LUN	NetApp	LUN C-Mode	12957	SILO	Healthy	CUG	Unavailable	SNMP Public V2	V2
14	ivolresnetapp_em7netapp_em7.lun		Storage.LUN	NetApp	LUN C-Mode	12964	SILO	Healthy	CUG	Unavailable	SNMP Public V2	V2
15	ivolresNew_Shared_DS_volresxi_shared_DS		Storage.LUN	NetApp	LUN C-Mode	12974	SILO	Healthy	CUG	Unavailable	SNMP Public V2	V2
16	ivolvol0lun0		Storage.LUN	NetApp	LUN	14073	Cloud-Hosting	Healthy	CUG	Active	SNMP Public V2	V2
17	ivolvol1lun0		Storage.LUN	NetApp	LUN	14072	Cloud-Hosting	Healthy	CUG	Active	SNMP Public V2	V2
18	ivolvol1lun0		Storage.LUN	NetApp	LUN	14070	Cloud-Hosting	Healthy	CUG	Active	SNMP Public V2	V2
19	ivolvol1lun0		Storage.LUN	NetApp	LUN	14068	Cloud-Hosting	Healthy	CUG	Active	SNMP Public V2	V2
20	ivolvol1lun0		Storage.LUN	NetApp	LUN	14071	Cloud-Hosting	Healthy	CUG	Active	SNMP Public V2	V2
21	ivolvol1lun0		Storage.LUN	NetApp	LUN	14069	Cloud-Hosting	Healthy	CUG	Active	SNMP Public V2	V2
22	ivolvol2lun0		Storage.LUN	NetApp	LUN	14075	Cloud-Hosting	Healthy	CUG	Active	SNMP Public V2	V2
23	ivolvol2lun0		Storage.LUN	NetApp	LUN	14074	Cloud-Hosting	Healthy	CUG	Active	SNMP Public V2	V2
24	10.0.13.20-CTIManager		UC Service	Cisco Systems	CTI Manager Service	14509	HQ Data Center	Healthy	CUG	Active	SNMP Public V2	V2
25	10.0.13.20-Extension Mobility		UC Service	Cisco Systems	Extension Mobility Service	14510	HQ Data Center	Healthy	CUG	Active	SNMP Public V2	V2
26	10.0.13.20-1flp		UC Service	Cisco Systems	1 TFP Service	14507	HQ Data Center	Healthy	CUG	Active	SNMP Public V2	V2
27	10.0.13.20-Tomcat		UC Service	Cisco Systems	Tomcat	14511	HQ Data Center	Healthy	CUG	Active	SNMP Public V2	V2
28	10.0.13.20-WebDialer Web Service		UC Service	Cisco Systems	Cisco WebDialer Service	14508	HQ Data Center	Healthy	CUG	Active	SNMP Public V2	V2
29	10.0.13.21-CTIManager		UC Service	Cisco Systems	CTI Manager Service	14519	HQ Data Center	Healthy	CUG	Active	SNMP Public V2	V2
30	10.0.13.21-Extension Mobility		UC Service	Cisco Systems	Extension Mobility Service	14522	HQ Data Center	Healthy	CUG	Active	SNMP Public V2	V2
31	10.0.13.21-1flp		UC Service	Cisco Systems	1 TFP Service	14518	HQ Data Center	Major	CUG	Active	SNMP Public V2	V2
32	10.0.13.21-Tomcat		UC Service	Cisco Systems	Tomcat	14521	HQ Data Center	Healthy	CUG	Active	SNMP Public V2	V2
33	10.0.13.21-WebDialer Web Service		UC Service	Cisco Systems	Cisco WebDialer Service	14520	HQ Data Center	Healthy	CUG	Active	SNMP Public V2	V2
34	10.0.13.22-CTIManager		UC Service	Cisco Systems	CTI Manager Service	14526	HQ Data Center	Healthy	CUG	Active	SNMP Public V2	V2
35	10.0.13.22-Extension Mobility		UC Service	Cisco Systems	Extension Mobility Service	14529	HQ Data Center	Healthy	CUG	Active	SNMP Public V2	V2
36	10.0.13.22-1flp		UC Service	Cisco Systems	1 TFP Service	14525	HQ Data Center	Major	CUG	Active	SNMP Public V2	V2
37	10.0.13.22-Tomcat		UC Service	Cisco Systems	Tomcat	14528	HQ Data Center	Healthy	CUG	Active	SNMP Public V2	V2
38	10.0.13.22-WebDialer Web Service		UC Service	Cisco Systems	Cisco WebDialer Service	14527	HQ Data Center	Healthy	CUG	Active	SNMP Public V2	V2
39	10.168.37.35		UC Device	Cisco Systems	H323 Trunk	14504	Enterprise Video	Healthy	CUG	Unavailable	SNMP Public V2	V2
40	192.168.40.196	192.168.40.196	Pingable	Linux	ICMP	12612	HQ Data Center	Healthy	CUG	Active	-	-
41	192.168.53.245-CTIManager		UC Service	Cisco Systems	CTI Manager Service	14378	HQ Data Center	Healthy	CUG	Unavailable	SNMP Public V2	V2
42	192.168.53.245-Extension Mobility		UC Service	Cisco Systems	Extension Mobility Service	14382	HQ Data Center	Healthy	CUG	Unavailable	SNMP Public V2	V2
43	192.168.53.245-1flp		UC Service	Cisco Systems	1 TFP Service	14379	HQ Data Center	Healthy	CUG	Unavailable	SNMP Public V2	V2
44	192.168.53.245-Tomcat		UC Service	Cisco Systems	Tomcat	14381	HQ Data Center	Healthy	CUG	Unavailable	SNMP Public V2	V2
45	192.168.53.245-WebDialer Web Service		UC Service	Cisco Systems	Cisco WebDialer Service	14380	HQ Data Center	Healthy	CUG	Unavailable	SNMP Public V2	V2
46	192.168.54.120		Servers.VMware	VMware	Host Server	13054	SILO	Healthy	CUG	Unavailable	-	-
47	192.168.54.121		Servers.VMware	VMware	Host Server	13053	SILO	Healthy	CUG	Unavailable	-	-
48	192.168.54.122		Servers.VMware	VMware	Host Server	12991	SILO	Healthy	CUG	Unavailable	-	-
49	192.168.54.123		Servers.VMware	VMware	Host Server	13025	SILO	Healthy	CUG	Unavailable	-	-
50	192.168.54.124		Servers.VMware	VMware	Host Server	12990	SILO	Healthy	CUG	Unavailable	-	-
51	192.168.54.125		Servers.VMware	VMware	Host Server	12994	SILO	Healthy	CUG	Unavailable	-	-
52	192.168.54.126		Servers.VMware	VMware	Host Server	12995	SILO	Healthy	CUG	Unavailable	-	-
53	20_Po13_Flexpod - Nexus_a		OEM	Cisco Systems	Nexus vPC	14655	SILO	Healthy	CUG	Unavailable	Cisco SNMPV2 -	V2
54	20_Po13_Flexpod - Nexus_b		OEM	Cisco Systems	Nexus vPC	14658	SILO	Healthy	CUG	Unavailable	SNMP Public V2	V2

Page 1

**NOTE:** If you want to include only specific devices in the report, use the "search as you type" fields at the top of each column. You can filter the list of devices by one or more column values. You can then generate the report, and only the devices displayed in the **Device Manager** page will appear in the report.

To generate a report about all or multiple devices:

1. Log in to SL1.
2. Go to the **Device Manager** page (Devices > Device Manager).

Device Manager | Devices Found [88] TRIAL LICENSE: 30 DAYS REMAINING

Device Name	IP Address	Device Category	Device Class / Sub-class	OID	Organization	Current State	Collection Group	Collection State	SNMP Credential	SNMP Service	SL Agent
10-64-171-130-CDB	10.64.171.130	System-EM7	ScenoeLogic, Inc   EM7 Database	1	System	Map	CUG	Active	EM7 Default V2	V2	No
7809S-NPE3-cisco.com	10.20.7.31	Network-Router	Cisco Systems   7809S	2	System	Map	CUG	Active	Cisco SNMP V2 - EV2	V2	No
AA-AIO-35-177	192.168.33.177	System-EM7	ScenoeLogic, Inc   EM7 All-in-One	13	System	Critical	CUG	Active	EM7 Default V3	V3	No
tsupekar-ai-o-62	10.2.15.92	System-EM7	ScenoeLogic, Inc   EM7 All-in-One	20	System	Map	CUG	Active	EM7 Default V2	V2	No
Automation-system1-110	10.2.15.110	System-EM7	ScenoeLogic, Inc   EM7 All-in-One	72	System	Map	CUG	Unavailable	EM7 Default V2	V2	No
Automation_GM_Br_10215111	10.2.15.111	System-EM7	ScenoeLogic, Inc   EM7 All-in-One	73	System	Map	CUG	Unavailable	EM7 Default V2	V2	No
syyoung-dist-cv-251	127.0.0.1	System-EM7	ScenoeLogic, Inc   EM7 Data Collector	88	System	Map	CUG	Active	EM7 Default V3	V3	No
CB-8.4AIO.33.205	192.168.33.205	System-EM7	ScenoeLogic, Inc   EM7 All-in-One	25	System	Map	CUG	Active	EM7 Default V3	V3	No
CB-8.5AIO.33.204	192.168.33.204	System-EM7	ScenoeLogic, Inc   EM7 All-in-One	24	System	Map	CUG	Active	EM7 Default V3	V3	No
cg-ai-o	192.168.33.181	System-EM7	ScenoeLogic, Inc   EM7 All-in-One	8	System	Map	CUG	Active	EM7 Default V3	V3	No
CUOM110-01 qa.scenoeologic.local	10.0.13.20	UC Device	Cisco Systems   CUOM Server	3	System	Map	CUG	Active	SNMP Public V2	V2	No
DB1	192.168.33.211	System-EM7	ScenoeLogic, Inc   EM7 Database	23	System	Map	CUG	Unavailable	EM7 Default V3	V3	No
DB2	192.168.33.222	System-EM7	ScenoeLogic, Inc   EM7 Database	41	System	Map	CUG	Unavailable	EM7 Default V3	V3	No
EM7-HADR-CUO	192.168.33.147	System-EM7	ScenoeLogic, Inc   EM7 Data Collector	86	System	Map	CUG	Active	EM7 Default V3	V3	No
em7-hadr-db1	192.168.33.141	System-EM7	ScenoeLogic, Inc   EM7 Database	84	System	Map	CUG	Active	EM7 Default V3	V3	No
em7-hadr-db2	192.168.33.146	System-EM7	ScenoeLogic, Inc   EM7 Database	85	System	Map	CUG	Active	EM7 Default V3	V3	No
em7-ai-o	192.168.33.180	System-EM7	ScenoeLogic, Inc   EM7 All-in-One	19	System	Critical	CUG	Active	EM7 Default V3	V3	No
em7-ai-o	10.64.98.16	System-EM7	ScenoeLogic, Inc   EM7 All-in-One	87	System	Map	CUG	Active	EM7 Default V3	V3	No
gsyrb080	192.168.33.129	System-EM7	ScenoeLogic, Inc   EM7 Database	61	System	Map	CUG	Active	EM7 Default V3	V3	No
gmstack01	10.2.15.100	System-EM7	ScenoeLogic, Inc   EM7 All-in-One	80	West Coast	Map	CUG	Unavailable	EM7 Default V2	V2	No
gmstack02	10.2.15.101	System-EM7	ScenoeLogic, Inc   EM7 All-in-One	59	East Coast	Map	CUG	Unavailable	EM7 Default V2	V2	No
gmstack03	10.2.15.102	System-EM7	ScenoeLogic, Inc   EM7 All-in-One	02	System	Map	CUG	Unavailable	EM7 Default V2	V2	No
gmstack04	10.2.15.103	System-EM7	ScenoeLogic, Inc   EM7 All-in-One	61	System	Map	CUG	Unavailable	EM7 Default V2	V2	No

3. To filter the list of devices, use the "search as you type" fields at the top of each column. You can filter the list of devices by one or more column values.
4. Click the **[Report]** button.
5. When prompted, specify the output format for the report and if you want to save the report.

# Generating a Report for a Single Device

From the **Device Manager** page (Devices > Device Manager), you can generate a detailed report on a single device. You can specify the information to include in the report (Full Report, Status, Config, Hardware, Notes, Software, Processes, Network, Events, Health) and the format in which the report will be generated (Create Report as HTML Document, Create Report as PDF Document, Create Report as MS Word Document, Create Report as MS Excel Document).

ScienceLogic		Device Report For: EM7-HADR-CU0		February 20, 2019, 10:22 am		Print Report	
<b>Device Information</b>							
Device	EM7-HADR-CU0 [86]						
IP Address	192.168.33.147 [Static address]						
SNMP Credentials	Read: EM7 Default V3						
Availability Port	UDP / 161						
Collection Time	2019-02-20 10:19:00						
Uptime	132 days, 16:08:14						
Device Category & Class	ScienceLogic, Inc. EM7 Data Collector						
Description	ScienceLogic EM7 G3 - Data Collector						
<b>Device Status</b>							
Current Health	Minor						
Current Availability	Okay						
Current Latency	0.1430 ms						
Collection Mode	Active						
24 Hr. Avail.	100.00% [Threshold: 99%]						
24 Hr. Latency	0.51 ms [Threshold: 100 ms]						
Events	Active: 1   Cleared: 1520						
Log Files	10,184						
<b>Active Events</b>							
	Event Message	Severity	Last Occurance	Count			
	Net-SNMP: CPU Has Exceeded Threshold: (80%) Currently (94.4703418457%)	Minor	2019-02-20 10:20:55	15544			
<b>Device Feature Preferences</b>							
Accept All Logs Feature	Enable						
Auto-Update Feature	Enable						
Auto-Clear Feature	Enable						
Daily Port Scan Feature	Enable						
Critical Ping Feature	Disable						
Preserve Hostname Feature	Enable						
Asset Update Feature	Disable						
<b>Device Thresholds</b>							
System Availability	99%						
System Latency	100 ms						
Rollover Percent	20%						
Out-of-order Percent	50%						
Device Logs Max	10,000 records						
Device Logs Age	90 days						
Bandwidth Data	31 days						
Normalized Band Data	730 days						
Performance Data	7 days						
Normalized Perf Data	730 days						
<b>Device Monitors</b>							
TCP-IP Ports	1						
System Processes	181						
Software Titles	543						
<b>Dynamic Application™ Collection</b>							
Host Resource: Configuration	Active						
EM7: Asset Information	Active						
Support: File System	Active						

To generate a detailed report on a single device:

1. Log in to SL1.

- Go to the **Device Manager** page (Devices > Device Manager).

Device Name	IP Address	Device Category	Device Class / Sub-class	DID	Organization	Current State	Collection State	Collection Size	SNMP Credential	SNMP Version	SL Agent
10-64-171-130-CDB	10.64.171.130	System:EM7	ScienceLogic, Inc   EM7 Database	1	System	Minor	CUG	Active	EM7 Default V2	V2	No
70095-NPE3.cisco.com	10.20.7.31	Network:Router	Cisco Systems   70095	2	System	Minor	CUG	Active	Cisco SNMPv2 - EV2		No
AA-AIO-33-177	192.168.33.177	System:EM7	ScienceLogic, Inc   EM7 All-in-One	13	System	Critical	CUG	Active	EM7 Default V3	V3	No
tsupekar-ai-o-92	10.2.15.92	System:EM7	ScienceLogic, Inc   EM7 All-in-One	29	System	Minor	CUG	Active	EM7 Default V2	V2	No
Automation-system1-110	10.2.15.110	System:EM7	ScienceLogic, Inc   EM7 All-in-One	72	System	Minor	CUG	Unavailable	EM7 Default V2	V2	No
Automation_GM_Sv_10215111	10.2.15.111	System:EM7	ScienceLogic, Inc   EM7 All-in-One	73	System	Minor	CUG	Unavailable	EM7 Default V2	V2	No
zyoung-dist-cu-251	127.0.0.1	System:EM7	ScienceLogic, Inc   EM7 Data Collector	88	System	Minor	CUG	Active	EM7 Default V3	V3	No
CB-6.4AIO.33.205	192.168.33.205	System:EM7	ScienceLogic, Inc   EM7 All-in-One	25	System	Minor	CUG	Active	EM7 Default V3	V3	No
CB-6.5AIO.33.204	192.168.33.204	System:EM7	ScienceLogic, Inc   EM7 All-in-One	24	System	Minor	CUG	Active	EM7 Default V3	V3	No
cg-ai-o	192.168.33.181	System:EM7	ScienceLogic, Inc   EM7 All-in-One	8	System	Minor	CUG	Active	EM7 Default V3	V3	No
CUCM10-01.qa.sciencelogic.local	10.0.13.20	UC:Device	Cisco Systems   CUCM Server	3	System	Minor	CUG	Active	SNMP Public V2	V2	No
DB1	192.168.33.211	System:EM7	ScienceLogic, Inc   EM7 Database	23	System	Minor	CUG	Unavailable	EM7 Default V3	V3	No
DB2	192.168.33.222	System:EM7	ScienceLogic, Inc   EM7 Database	41	System	Minor	CUG	Unavailable	EM7 Default V3	V3	No
EM7-HADR-CU0	192.168.33.147	System:EM7	ScienceLogic, Inc   EM7 Data Collector	86	System	Minor	CUG	Active	EM7 Default V3	V3	No
em7-hadr-dt1	192.168.33.141	System:EM7	ScienceLogic, Inc   EM7 Database	84	System	Minor	CUG	Active	EM7 Default V3	V3	No
em7-hadr-dt2	192.168.33.146	System:EM7	ScienceLogic, Inc   EM7 Database	85	System	Minor	CUG	Active	EM7 Default V3	V3	No
em7-ao	192.168.33.180	System:EM7	ScienceLogic, Inc   EM7 All-in-One	19	System	Critical	CUG	Active	EM7 Default V3	V3	No
em7-ao	10.64.88.16	System:EM7	ScienceLogic, Inc   EM7 All-in-One	87	System	Minor	CUG	Active	EM7 Default V3	V3	No
em7-ao	192.168.33.129	System:EM7	ScienceLogic, Inc   EM7 Database	81	System	Minor	CUG	Active	EM7 Default V3	V3	No
em7-ao	10.2.15.100	System:EM7	ScienceLogic, Inc   EM7 All-in-One	80	West Coast	Minor	CUG	Unavailable	EM7 Default V2	V2	No
em7-ao	10.2.15.101	System:EM7	ScienceLogic, Inc   EM7 All-in-One	59	East Coast	Minor	CUG	Unavailable	EM7 Default V2	V2	No
em7-ao	10.2.15.102	System:EM7	ScienceLogic, Inc   EM7 All-in-One	62	System	Minor	CUG	Unavailable	EM7 Default V2	V2	No
em7-ao	10.2.15.103	System:EM7	ScienceLogic, Inc   EM7 All-in-One	61	System	Minor	CUG	Unavailable	EM7 Default V2	V2	No

- In the **Device Manager** page, find the device for which you want to generate a detailed report. Select the printer icon () for that device.
- The **Report Creator** modal page appears. In the **Report Creator** modal page, you can specify which information to include in the device report and the format in which the report will be generated.

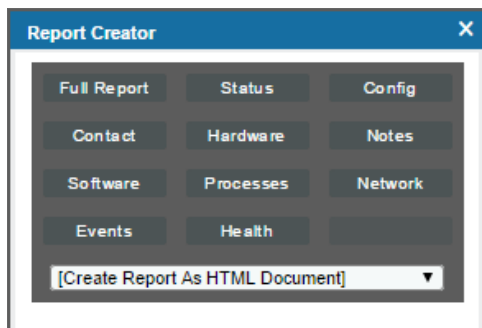

- Select one of the following to specify the information to include in the device report:
  - [Full Report]**. Includes information about device status, status of all device policies, status of all monitors, status of hardware components, status of all thresholds defined for the device, a list of all active events associated with the device, and information about the last collection time and last entry to the device log.
  - [Status]**. Includes information about device status, status of all monitors, status of hardware components, status of all thresholds defined for the device, and information about the last collection time and last entry to the device log.
  - [Config]**. Includes status of all monitors, status of all thresholds defined for the device, and information about the last collection time and last entry to the device log.

- **[Contacts]**. Includes contact information for the device's organization and contact information for all vendors and warranty/support accounts.
- **[Hardware]**. Includes overview of hardware components for the device.
- **[Notes]**. Includes all notes created in the **Notepad Editor** page.
- **[Software]**. Displays a list of software installed on the device.
- **[Processes]**. Displays a list of all processes running on the device.
- **[Network]**. Includes information about network ports and network configuration.
- **[Events]**. Includes a list of all active events associated with the device.
- **[Health]**. Includes information about device status, status of all monitors, status of all Dynamic Applications associated with the device, status of all thresholds defined for the device, and a list of all active events associated with the device.

6. Select from the following list of formats in which the report can be generated:

- Create Report as HTML Document
- Create Report as PDF Document
- Create Report as MS Word Document
- Create Report as MS Excel Document
- CSV - Comma Separated Values

---

## Viewing the List of Component Devices

You can view the list of component devices from the **Device Components** page. To view the list of component devices:

1. Go to the **Device Components** page (Devices > Device Components).



2. The **Device Components** page displays the following about each device:





Device Components   Devices Found [35]										
Device Name *	IP Address	Device Category	Device Class   Sub-class	DID	Organization	Current State	Collection Group	Collection State		
172.16.243.29	172.16.243.29	ContactCenter	Cisco Systems   Voice Portal (CVP)	131	RNG	Healthy	CUG	Active		
172.16.243.38	172.16.243.38	ContactCenter	Cisco Systems   Voice Portal (CVP)	133	RNG	Minor	CUG	Active		
172.16.243.39	172.16.243.39	ContactCenter	Cisco Systems   Voice Portal (CVP)	134	RNG	Minor	CUG	Active		
198.18.133.201:common	--	Infrastructure	Cisco Systems   ACI Tenant	1328	Cisco_ACI_Regression_Test	Healthy	CUG	Active		
198.18.133.201:infra	--	Infrastructure	Cisco Systems   ACI Tenant	1322	Cisco_ACI_Regression_Test	Healthy	CUG	Active		
198.18.133.202:common	--	Infrastructure	Cisco Systems   ACI Tenant	1333	Cisco_ACI_Regression_Test	Healthy	CUG	Active		
198.18.133.202:infra	--	Infrastructure	Cisco Systems   ACI Tenant	1339	Cisco_ACI_Regression_Test	Healthy	CUG	Active		
Amazon	--	Service	Service   AWS Service	1628	AWS Elana	Healthy	CUG	Active		
apic1	198.18.133.200	Utility	Cisco Systems   ACI	1557	Cisco_ACI_Regression_Test	Minor	CUG	Active		
apic1:common	--	Infrastructure	Cisco Systems   ACI Tenant	339	Cisco_ACI_Regression_Test	Minor	CUG	Active		
apic1:infra	--	Infrastructure	Cisco Systems   ACI Tenant	337	Cisco_ACI_Regression_Test	Minor	CUG	Active		
AZURE CLASSIC SSH	--	Service	Microsoft   Azure Services Classic	4594	Azure CLASSIC SSH	Healthy	CUG	Active		
CUCM10-01 qa.sciencelogic.local	10.0.13.20	Cluster	Cisco Systems   CUCM Cluster	169	RNG	Minor	CUG	Active		
cucm8	10.168.44.22	Cluster	Cisco Systems   CUCM Cluster	1276	System	Healthy	CUG	User-Disabled		
CUCM9-01 qa.sciencelogic.local	10.64.160.10	Cluster	Cisco Systems   CUCM Cluster	168	RNG	Minor	CUG	Active		
CUCM10-diduid.cisco.com	10.2.10.76	ContactCenter	Cisco Systems   Contact Center (CCE)	1274	System	Minor	CUG	Unavailable		
dc2aCUCM01.corp.sciencelogic.net	10.128.11.32	Cluster	Cisco Systems   CUCM Cluster	1275	System	Minor	CUG	Active		
fxepoc1b1	10.5.100.20	Pingable	Linux   ICMP	410	UCS	Notice	CUG	Active		
ms-082-dcqa1	10.1.0.140	Servers	Microsoft   Windows Server 2008 R2	5614	RS_PowershellDevices	Minor	CUG	Active		
ms-082-lync	10.1.0.139	Servers	Microsoft   Windows Server 2008 R2	5615	RS_PowershellDevices	Minor	CUG	Active		
ms12c-dc-qa14	10.1.0.137	Servers	Microsoft   Windows Server 2012 R2	5611	RS_PowershellDevices	Minor	CUG	Active		
ms12c-lync13	10.1.0.142	Servers	Microsoft   Windows Server 2012 R2	5613	RS_PowershellDevices	Minor	CUG	Active		
Office365_MSDN	--	Account	Microsoft   Office 365 Account	1086	RS_Office365	Healthy	CUG	Active		
POD7-AW1.caasdemo.com	172.16.243.37	ContactCenter	Cisco Systems   Contact Center (CCE)	135	RNG	Healthy	CUG	Active		
POD7-PG1A.caasdemo.com	172.16.243.23	ContactCenter	Cisco Systems   Contact Center (CCE)	128	RNG	Healthy	CUG	Active		

**TIP:** To sort the list of devices, click on a column heading. The list will be sorted by the column value, in ascending order. To sort by descending order, click the column heading again.

- **Plus-sign icon** ( + ). Clicking on this icon expands the device and displays the children devices underneath the device. Each device that displays a plus-sign icon has children devices.
- **Minus-sign icon** ( - ). Clicking on this icon collapses the device and hides the children devices for this device. Each device that displays a minus-sign icon has children devices.
- **Device Name.** Name of the device. For devices running SNMP, component devices, or devices with DNS entries, the name is discovered automatically. For root devices without SNMP or DNS entries, the device's IP address will appear in this field.
- **IP Address.** The IP address of the device. Appears only for physical devices.
- **Device Category.** The category assigned to the device. Categories include servers, routers, switches, firewalls, printers, etc. The category is automatically assigned during discovery, at the same time as the as Device-Class/Sub-Class.
- **Device-Class/Device Sub-Class.** The manufacturer (device class) and type of device (sub-class). The Device-Class/Sub-Class is automatically assigned during discovery, at the same time as the as Category.
- **DID.** Device ID. This is a unique number automatically assigned to the device by SL 1 .
- **Organization.** The Organization to which the device is assigned.
- **Current State.** Condition of the device, based upon events generated by the device. Condition can be one of the following:
  - *Critical.* Device has serious problem that requires immediate attention.



- *Major*. Device has problem that requires immediate attention.
  - *Minor*. Device has less-serious problem.
  - *Notice*. Device has an informational event associated with it.
  - *Healthy*. Device is running with no problems.
- **Collector Group**. Specifies the collector group to which the device belongs. Collector Groups are defined in System > Settings > Collector Groups and specify one or more Data Collectors. A Data Collector is the appliance that gathers data from the device. For All-In-One Appliances, this field displays only the built-in Collector Group (and any virtual Collector Groups)
  - **Collection State**. Collection state can be one of the following:
    - *Active*. SL1 is currently collecting data from the device.
    - *User-Disabled*. Collection has been manually disabled for this device by a user. SL1 will not collect data from the device until a user manually re-enables collection.
    - *Unavailable*. The device is currently unavailable, so SL1 cannot collect data from the device at this time.
    - *Component Vanished*. The component device has vanished, i.e. is not currently being reported by its root device. SL1 cannot collect data from the device at this time.
  - **Tools**. Displays icons for managing devices. The choices are:
    - *Device Administration* (): Leads to the **Device Properties** page, where you can define basic device parameters and parameters for auto-discovery. From the **Device Properties** page, you can also access the other pages in the Device Administration tools
    - *Device Management* (): Leads to the **Device Summary** page, where you can see reports and logs related to the device. From the **Device Summary** page, you can also access the other pages in the Device Management tools.
    - *Interfaces* (). Leads to the **Interfaces Found** page, where you can view details about each network interface on the device.

- *Print Report* (). Generates a report for the selected device. Opens the **Report Selector** modal page, where you can specify the information to include in the report (Full Report, Status, Config, Hardware, Notes, Software, Processes, Network, Events, Health) and the format in which the report will be generated (HTML Document, PDF Document, MS Word Document, MS Excel Document, CSV File).
- *Create Ticket* (). Leads to the **Ticket Editor** page, where you can define and file a new ticket for the device.
- *View Asset Record* (). This icon appears if an asset record has already been defined for the device. This icon leads to the **Asset Properties** page, where you can view the asset record for the device.
- *Create Asset Record* (). This icon appears if an asset record has not been defined for the device. This icon leads to the **Asset Properties** page, where you can create an asset record for the device.
- *Checkbox* (). Applies the action in the **[Select Action]** drop-down to the device. To select all the checkboxes, select the large red check icon.

## Availability for Component Devices

The following rules apply to the availability state for component devices:

- Component devices can use a Component Identifier to monitor availability. However, in a tree of component devices, some component devices might have a component identifier for availability and others might not. For example, suppose a component device has a component identifier for availability, and SL1 considers that component device "unavailable". All the descendents of that component device that do not have their own component identifier for availability will be considered unavailable. As soon as SL1 finds a descendent with its own component identifier for availability, SL1 stops checking that descendent and its descendents for availability. Component devices without their own component identifier for availability inherit their availability from their nearest ancestor that has a component identifier for availability.
- For trees that include merged devices, so include both hardware devices and component devices, SL1 skips over the hardware devices and allows them to use a network-based protocol to determine availability. For example, suppose you have a tree like this:
  - Grandparent device is a component device with a component identifier for availability. SL1 has determined that the grandparent device is unavailable.
  - Child device is a hardware device that uses ICMP and ping to determine availability. When SL1 evaluates the grandparent's component identifier, SL1 skips over this device. ICMP and ping determine the availability of this device.
  - Grandchild device is a component device that does not have its own component identifier for availability. When SL1 evaluates the grandparent's component identifier, SL1 assigns the grandparent's availability to this grandchild device.
- If all the hosts in a cluster are powered off or unavailable in a VMware system, both the hardware-based hosts and the associated component devices will display the value *Unavailable* in the **Collection State** column. When at least one host in the cluster becomes available, some or all of the associated component devices will also become available.

## Viewing Children Devices

You can view component child devices of a root device in the **Device Components** page. If that child device also serves as a root device, you can also view its component child devices, and so forth. To view component children devices for root devices:

1. Go to the **Device Components** page (Devices > Device Components).
2. In the **Device Components** page, find the root device for which you want to view its component children. Select its plus sign icon ( **+** ).
3. The device will be expanded to display the component children devices below the root device.

The screenshot shows a table titled "Device Components | Devices Found [35]". The table has columns for Device Name, IP Address, Device Category, Device Class | Sub-class, DID, Organization, Current State, Collection Group, and Collection State. The table is organized into expandable sections. The first section is expanded, showing a root device (172.16.243.29) and its children (H323.2, ICM.4, IWR.3, SIP.1, VXML.5). The second section is also expanded, showing a root device (172.16.243.38) and its child (Reporting.1). The third section is expanded, showing a root device (172.16.243.39) and its children (H323.2, ICM.4, IWR.3, SIP.1, VXML.5). The fourth section is expanded, showing a root device (198.18.133.201-common) and its child (default). The fifth section is expanded, showing a root device (198.18.133.201-infra) and its child (default). Each device has a plus sign icon to expand and a minus sign icon to collapse. The table also includes a search bar and a "Viewing Page: 1" indicator.

Device Name	IP Address	Device Category	Device Class   Sub-class	DID	Organization	Current State	Collection Group	Collection State
172.16.243.29	172.16.243.29	ContactCenter	Cisco Systems   Voice Portal (CVP)	131	RNG	Notice	CUG	Active
Device Name * IP Address Device Category Device Class   Sub-class DID Organization Current State Collection Group Collection State								
172.16.243.29	--	ContactCenter	Cisco Systems   CVP H323 Instance	141	RNG	Major	CUG	Active
ICM.4	--	ContactCenter	Cisco Systems   CVP ICM Instance	143	RNG	Healthy	CUG	Active
IWR.3	--	ContactCenter	Cisco Systems   CVP IWR Instance	142	RNG	Healthy	CUG	Active
SIP.1	--	ContactCenter	Cisco Systems   CVP SIP Instance	140	RNG	Healthy	CUG	Active
VXML.5	--	ContactCenter	Cisco Systems   CVP VXML Instance	144	RNG	Major	CUG	Active
172.16.243.38	172.16.243.38	ContactCenter	Cisco Systems   Voice Portal (CVP)	133	RNG	Major	CUG	Active
Device Name * IP Address Device Category Device Class   Sub-class DID Organization Current State Collection Group Collection State								
172.16.243.38	--	ContactCenter	Cisco Systems   CVP Reporting Instance	145	RNG	Healthy	CUG	Active
172.16.243.39	172.16.243.39	ContactCenter	Cisco Systems   Voice Portal (CVP)	134	RNG	Minor	CUG	Active
Device Name * IP Address Device Category Device Class   Sub-class DID Organization Current State Collection Group Collection State								
172.16.243.39	--	ContactCenter	Cisco Systems   CVP H323 Instance	147	RNG	Major	CUG	Active
ICM.4	--	ContactCenter	Cisco Systems   CVP ICM Instance	148	RNG	Healthy	CUG	Active
IWR.3	--	ContactCenter	Cisco Systems   CVP IWR Instance	149	RNG	Healthy	CUG	Active
SIP.1	--	ContactCenter	Cisco Systems   CVP SIP Instance	146	RNG	Healthy	CUG	Active
VXML.5	--	ContactCenter	Cisco Systems   CVP VXML Instance	150	RNG	Major	CUG	Active
198.18.133.201-common	--	Infrastructure	Cisco Systems   ACI Tenant	1328	Cisco_ACI_Regression_Test	Healthy	CUG	Active
Device Name * IP Address Device Category Device Class   Sub-class DID Organization Current State Collection Group Collection State								
198.18.133.201-common	--	Infrastructure	Cisco Systems   ACI Application Network Profile	1338	Cisco_ACI_Regression_Test	Healthy	CUG	Active
198.18.133.201-infra	--	Infrastructure	Cisco Systems   ACI Tenant	1322	Cisco_ACI_Regression_Test	Healthy	CUG	Active

4. You can select the plus sign icon for each component child device that also serves as a root device. To collapse the component child devices, select their minus sign icon ( **-** ).

## Filtering the List of Component Devices

You can filter the list on the **Device Components** page by one or more parameters. Only component devices that meet all the filter criteria will be displayed in the **Device Components** page.

To filter by each parameter except **Current State**, enter text into the desired filter-while-you-type field. The **Device Components** page searches for component devices that match the text, including partial matches. By default, the cursor is placed in the left-most filter-while-you-type field. You can use the <Tab> key or your mouse to move your cursor through the fields. The list is dynamically updated as you type. Text matches are not case-sensitive.

You can also use special characters to filter each parameter.

Filter the list by one or more of the following parameters:

- **Device Name.** You can enter text to match, including special characters, and the **Device Components** page will display only devices that have a matching device name.
- **IP Address.** You can enter text to match, including special characters, and the **Device Components** page will display only devices that have a matching IP address.
- **Device Category.** You can enter text to match, including special characters, and the **Device Components** page will display only devices that have a matching device category.
- **Device Class | Sub-Class.** You can enter text to match, including special characters, and the **Device Components** page will display only devices that have a matching device class.
- **DID.** You can enter text to match, including special characters, and the **Device Components** page will display only devices that have a matching device ID.
- **Organization.** You can enter text to match, including special characters, and the **Device Components** page will display only devices that have a matching organization.
- **Current State >=.** Specifies the device's current state. Only those devices that match all the previously selected fields and have the specified condition will be displayed. A device's condition is determined by its most severe, outstanding event. The choices are:
  - **>=Healthy.** Include devices with a condition of "Healthy" or greater. This will include all devices.
  - **>=Notice.** Include devices with a condition of "Notice" or greater. This means, include devices with a condition of "Notice", "Minor", "Major", and "Critical".
  - **>=Minor.** Include devices with a condition of "Minor" or greater. This means, include devices with a condition of "Minor", "Major", and "Critical".
  - **>=Major.** Include devices with a condition of "Major" or greater. This means, include devices with a condition of "Major" and "Critical".
  - **>=Critical.** Include devices with a condition of "Critical" or greater. This means, include devices with a condition of "Critical", because there is no "greater" condition.
- **Collection Group.** You can enter text to match, including special characters, and the **Device Components** page will display only devices that have a matching Collector Group.
- **Collection State.** You can enter text to match, including special characters, and the **Device Components** page will display only devices that have a matching Collection State.

**TIP:** To return to the default list of events, select the **[Reset]** button.

## Using the Advanced Filter with the List of Component Devices

You can use the Advanced Filter tool to select one or more parameters to filter the display of devices in the **Device Components** page. Only devices that meet all the filter criteria will be displayed.

- TIP:** To select multiple entries in the Advanced Filter tool, hold down the <Ctrl> key and left-click the entries.
- After selecting all filters, select the **[Apply]** button to apply the filters to the list of devices.
  - To reset each field and apply no filters, select the Reset button.

To access the Advanced Filter tool:

1. Go to the **Device Components** page (Devices > Device Components).
2. Click on the funnel icon (  ).
3. The Advanced Filter Tool will display advanced filters for each column in the page. You can filter by one or more of the following parameters:

**NOTE:** Unlike the "*filter-while-you-type*" feature, the Advanced Filter tool is not applied to the list of devices until you select the **Apply** button

- **Device Name.** In the *Match Any* fields, you can enter one or more text strings to match, including special characters. The **Device Components** page will display only devices that have a matching device name.
  - **IP Address.** In the *Match Any* fields, you can enter one or more text strings to match, including special characters. The **Device Components** page will display only devices that have a matching IP address.
  - **Device Category.** Select from a list of device categories that have member devices. The **Device Components** page will display only devices that have a matching device category.
  - **Device Class | Sub-class.** In the *Match Any* fields, you can enter one or more text strings to match, including special characters. The **Device Components** page will display only devices that have a matching device class or sub-class.
  - **DID.** In the *From* and *To* field, you can specify a range of device IDs. The **Device Components** page will display only devices that fall within that range of device IDs.
  - **Organization.** Select from a list of organizations that have member devices. The **Device Components** page will display only devices that have a matching organization.
  - **Current State.** You can select from a list of device states. The **Device Components** page will display only devices that have a matching state.
  - **Collection Group.** Select from a list of collection groups that have member devices. The **Device Components** page will display only devices that have a matching collection group.
  - **Collection State.** Select from a list of collection states that have member devices. The **Device Components** page will display only devices that have a matching collection state.
4. After selecting the desired filters, click the **[Apply]** button to filter the list of devices.
  5. To reset each field and apply no filters, click the **[Reset]** button.

**TIP:** You can perform an advanced filter and then perform a second advanced filter on the results of the first advanced filter. You can continue to modify and apply an advanced filter multiple times.

## Bulk Actions in the Device Management Page

The **Device Manager** page (Devices > Device Manager) contains a drop-down field in the lower right called **Select Action**. This field allows you to apply an action to multiple devices at once.

To apply an action to multiple devices:

1. In the **Device Manager** page, select the checkbox for each device you want to apply the action to. To select all checkboxes for all devices, select the red checkbox (☑) at the top of the page.

The screenshot shows the 'Device Manager' page with a table of 24 devices. At the top right of the table, there is a 'Select Action' dropdown menu. The table columns include: Device Name, IP Address, Device Category, Device Class / Sub-class, DUID, Organization, Current Status, Collection Status, Collection Date, SNMP Credentials, and Bulk Action. The 'Bulk Action' column contains a red checkbox (☑) at the top, indicating that all devices are selected. The 'Current Status' column shows various statuses like 'Active', 'Unavailable', and 'Critical'.

2. In the **Select Action** drop-down list, select one of the following actions:

- **Delete Devices.** Deletes all selected devices from SL1. Tickets associated with the device are unlinked from the device, but are not deleted.
- **Modify by Template.** Displays the **Applying Template to Device** page, where you can apply the settings in a device template to all selected devices. You can also make one-time changes to the template, and those changes will be applied only to the selected devices. For details on using device templates, see the manual **Device Groups and Device Templates**.
- **Clear Device Logs.** Deletes data from the device's log files. For details on device logs, see the manual **Monitoring Device Infrastructure Health**.
- **Create Asset Record.** Creates an asset record for each selected device. For details on asset records, see the **Asset Management** manual.

- **Schedule Maintenance.** Leads to the **Maintenance Schedule** page. In this page you can specify a date and time to put each selected device into "maintenance mode". During maintenance mode, SL1 will not generate events about the selected devices. You can choose to disable or enable polling during maintenance mode. Even if polling is enabled, SL1 will collect information from the selected devices but will not generate events for the devices. For details on scheduling maintenance, see the section on [Maintenance](#).
- **Find Collection Label Duplicates.** Leads to the **Duplicates** page. In this page, you can view a list of devices where the Collection Labels have more than one possible presentation object aligned. From this page, you can manually align a single presentation object with a Collection label for a device. For more information on Collection Labels, see the manual **Monitoring Device Infrastructure Health**.
- **Change Collection State.** Changes the status of the device in SL1. The choices are:
  - *Active.* SL1 polls the device on a regular basis and updates the data displayed in SL1.
  - *Disabled.* SL1 does not poll the device. Data displayed in SL1 is not updated.
- **Change User Maintenance Mode.** Changes the user maintenance mode setting for the selected devices. For details on user maintenance mode, see the section on [Maintenance](#).
- **Change Collector Group:** Changes the Data Collector(s) used to collect data from the device. Choose from the list of all Collector Groups in SL1. When you select one of the collector groups, each selected device will be polled by the collectors in the collector group. This option does not appear for All-In-One Appliances. For details on collector groups and their relationships to devices, see the manual **System Administration**.
- **Move To Organization:** Associates a device with an organization. The list of choices will include all organizations in SL1. For details on organizations in SL1, see the manual **Organizations and Users**.
- **Align SNMP Read Credential.** This option applies the selected credential to all selected devices. The selected devices will use the selected credential as their primary credential. Secondary credentials will remain unchanged. Choose from a list of all SNMP Read credentials in SL1 (defined in the **Credential Management** page [System > Manage > Credentials]). For more details on Credentials, see the manual on **Credentials and Discovery**.
- **Add to Device Group.** This option aligns the selected devices with the selected device group. The selected devices will then appear in Device Group Views and will inherit the properties of the device group, including scheduling, access, and visibility.
- **Align to Device Dashboard.** This option aligns the selected device dashboard with the selected device group. Choose from a list of all device dashboards in SL1 (defined in the **Device Dashboards** page [System > Customize > Device Dashboards]). For more details on Device Dashboards, see the [Device Dashboards](#) section.

---

## Bulk Actions for Component Devices

The **Device Components** page (Devices > Device Components) contains a drop-down field in the lower right called **Select Action**. This field allows you to apply an action to multiple devices at once.

To apply an action to multiple devices:

1. In the **Device Components** page, select the checkbox for each device you want to apply the action to. To select all checkboxes for all devices, select the red checkbox (☑) at the top of the page.
2. In the **Select Action** drop-down list, select one of the following actions:
  - **Delete Selected Devices**. Deletes all selected devices from SL1. Tickets associated with the device are unlinked from the device, but are not deleted.

**NOTE:** To delete a root device and its associated component devices, use the option **Delete Selected Devices (recursive)**.

- **Delete Selected Devices (recursive)**. Deletes all selected devices from SL1. If one or more of the selected devices is a root device with one or more component devices as children, this option deletes the root device and the component devices. Tickets associated with the deleted device are unlinked from the device, but are not deleted.
- **Modify by Template**. Displays the **Applying Template to Device** page, where you can apply the settings in a device templates to all selected devices. You can also make one-time changes to the template, that will be applied only to the selected devices.
- **Clear Device Logs**. Deletes data from the device's log files.
- **Schedule Maintenance**. Leads to the **Maintenance Schedule** page. In this page, you can specify a date and time to put each selected device into "maintenance mode". During maintenance mode, SL1 will not generate events about the selected devices. You can choose to enable or disable polling during maintenance mode. Even if polling is enabled, SL1 will collect information from the selected devices but will not generate events for the devices.
- **Create Asset Record**. Automatically creates an asset record for the device. SL1 automatically populates as many fields as possible, using retrieved data.
- **Change Collection State**. Changes the status of the device in SL1. The choices are:
  - *Active*. SL1 polls the device on a regular basis and updates the data displayed in SL1.
  - *Active (recursive)*. SL1 polls the device on a regular basis and updates the data displayed in SL1. SL1 also polls all children devices (of the selected device) on a regular basis and updates their data.
  - *Disabled*. SL1 does not poll the device. Data displayed in SL1 is not updated.
  - *Disabled (recursive)*. SL1 does not poll the device. SL1 does not update data about the device. SL1 also does not poll any children devices (of the selected device) and does not update data about the children devices.
- **Change Collector Group**. Changes the collector group used to collect data from the device. Choose from the list of all collector groups and virtual collector groups in SL1. When you select one of the collector groups, each selected device will be polled by the collectors in the collector group. For All-In-One Appliances, you can select only the built-in Collector Group and any virtual Collector Groups.
  - If you align a device with a virtual Collector Group, SL1 will store all historical data from all aligned devices, but will no longer perform collection on those devices or trigger events for these devices.



- **Move to Organization.** Associates a device with an organization. The list of choices will include all organizations in SL1.
- **Align SNMP Read Credential.** This option applies the selected credential to all selected devices. The selected devices will use the selected credential as their primary credential. Secondary credentials will remain unchanged. Choose from a list of all SNMP Read credentials in SL1 (defined in System > Manage > Credentials).
- **Add to Device Group.** This option aligns the selected devices with the selected device group. The selected devices will then appear in **Device Group Views** and will inherit the properties of the device group, including scheduling, access, and visibility.

3. Select the **[Go]** button. SL1 will apply the selected option to the selected devices.

---

## Bulk Merging and Unmerging of Devices

If your SL1 system includes a physical device and a component device, you can merge those device records into a single record for easier monitoring. Merging consolidates the devices and their data—device fields, values, graphs, behaviors, and other user interface elements—providing you with a single set of data for the device. Additionally, merged devices consume only a single device license.

Merging does not remove, replace, or add any data; merging simply groups data together. When you merge a physical device and a component device, the device record for the component device no longer displays in the user interface, while the device record for the physical device displays in user interface pages that previously displayed the component device. For example, the physical device is displayed instead of the component device in the **Device Components** page and the **Component Map** page. All existing and future data for both devices will be associated with the record for the physical device.

Merged devices can be unmerged back into individual device records, if needed.

The **Device Manager** page (Devices > Device Manager) contains options for the bulk merging or unmerging of multiple pairs of physical and component devices. These features are convenient if you have a large number of devices you want to merge or unmerge in a single session.

**NOTE:** You can merge only two individual devices together into a single merged device. To do so, you must have user permissions that allow merging and unmerging on both devices.

**NOTE:** When you merge devices, active events associated with the component device will be set to "cleared." The cleared events will not be associated with the physical device. If the devices are unmerged, the cleared events cannot be moved back to the component device.

**CAUTION:** Merging devices also merges the log data from each device. The log data cannot later be unmerged.

# Performing a Bulk Device Merge

If you have a large number of devices to merge, you can perform a bulk device merge, which is more efficient than merging device pairs individually. A bulk device merge enables you to select from multiple pairs of devices—particularly those with matching IP addresses or device names—and choose the pairs to merge.

**NOTE:** If you have a small number of physical and component devices that you want to merge, you can merge each pair individually. For more information, see the [Merging Individual Devices](#) section.

To perform a bulk device merge:

1. Go to the **Device Manager** page (Devices > Device Manager).
2. Select the **[Actions]** menu and then choose **Merge Devices**.

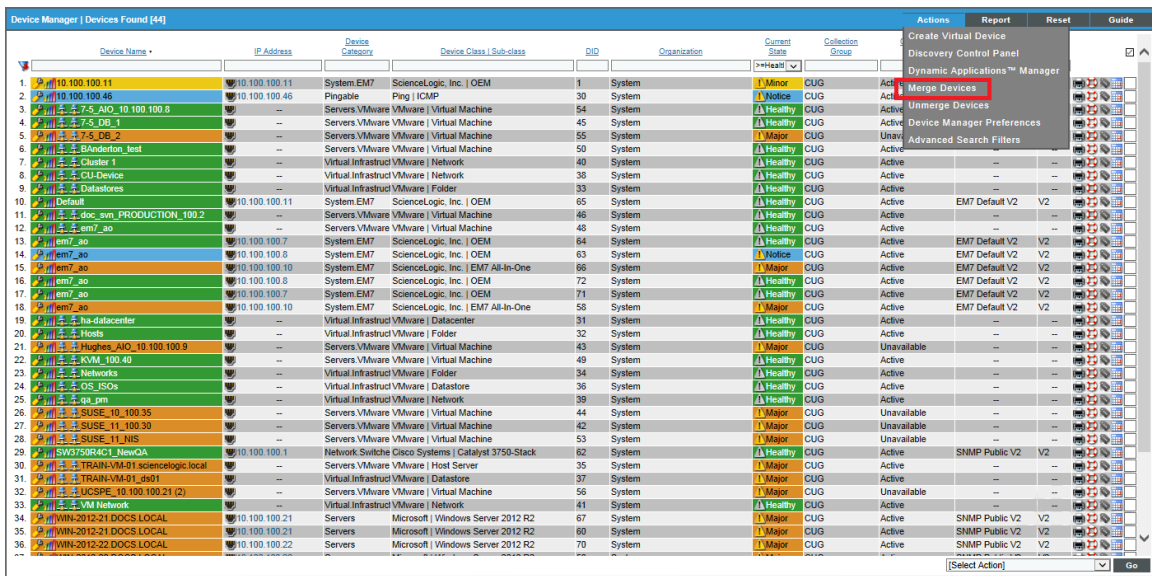

**TIP:** Because of the potentially large number of devices that could be merged, no results display when the **Device Bulk Merge** page initially displays. You must select one of the checkboxes or begin typing a name in the **Names Contain** field for results to display on the page.

3. On the **Device Bulk Merge** page:

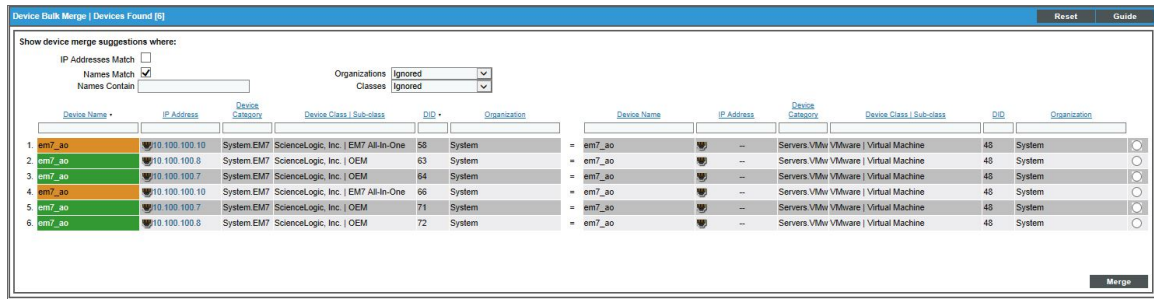

- Select the **IP Addresses Match** checkbox if you want the page to display a list of devices where the physical device and the component device have matching IP addresses.
- Select the **Names Match** checkbox if you want the page to display a list of devices where the physical device and the component device have matching Device Names.
- If you want the page to display a list of devices that could be merged where the Device Names of the physical device and the component device contain the same character(s), enter those characters in the **Names Contain** field.
- In the **Organizations** field:
  - Select *Ignored* if you do not want to filter the list of devices based on the Organizations assigned to the physical device and the component device.
  - Select *Match* if you want to filter the list of devices to include only physical devices and component devices that have matching Organizations.
  - Select *Don't Match* if you want to filter the list of devices to include only physical devices and component devices that do not have matching Organizations.
- In the **Classes** field:
  - Select *Ignored* if you do not want to filter the list of devices based on the Device Classes assigned to the physical device and the component device.
  - Select *Match* if you want to filter the list of devices to include only physical devices and component devices that are assigned matching Device Classes.
  - Select *Don't Match* if you want to filter the list of devices to include only physical devices and component devices that are assigned non-matching Device Classes.

**NOTE:** You can make selections in the **Organizations** and **Classes** fields only after you make a selection or entry in the **IP Addresses Match**, **Names Match**, and/or **Names Contain** fields.

The **Device Bulk Merge** page displays a list of physical device and component device pairs that match your search criteria. Each numbered row indicates a pair of devices that could be merged.

4. Select the radio button(s) in the last column of each row of device pairs that you want to merge, then select the **[Merge]** button. The radio buttons are grouped per physical device, i.e., you can select only one row for each physical device.

**NOTE:** You can select each component device only once for merging. If you attempt to select the same component device in multiple rows, you will receive an error message when you select the **[Merge]** button.

5. A modal window displays that asks you to confirm the merge. Select the **[Yes]** button.

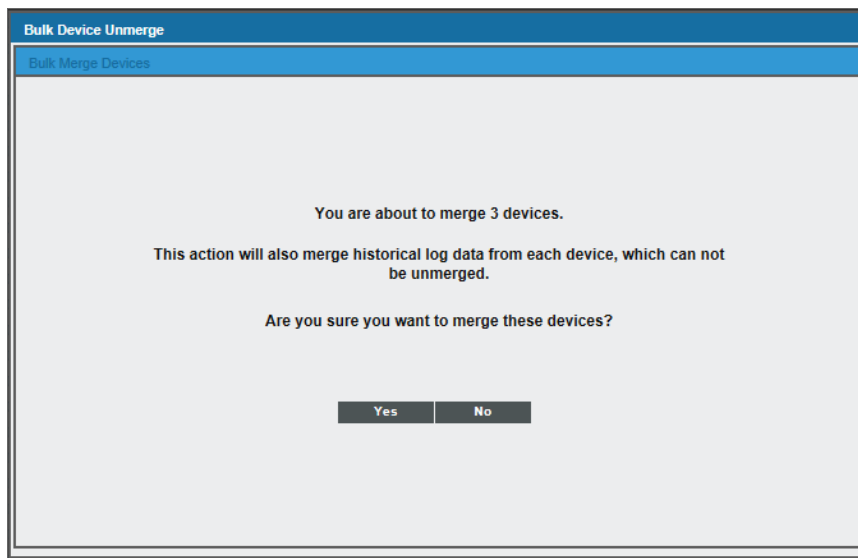

6. SL1 begins merging the selected devices. When the message, "Device Bulk Merge complete" displays, select the **[Close/Esc]** button.

**NOTE:** To view an updated list of devices that includes your merged devices, select the **[Reset]** button on the **Device Manager** page.

## Performing a Bulk Device Unmerge

If you have a large number of devices to unmerge, you can perform a bulk device unmerge, which is more efficient than unmerging device pairs individually. A bulk device unmerge enables you to view a list of merged devices and select all of the devices you want to unmerge.

**NOTE:** If you have a small number of devices that you want to unmerge, you can unmerge each pair individually. For more information, see the [Unmerging Individual Devices](#) section.

**NOTE:** For details on unmerging a vanished device, see the chapter in this manual on *Vanishing & Purging Devices*.

To unmerge multiple devices:

1. Go to the **Device Manager** page (Devices > Device Manager).
2. Select the **[Actions]** menu and then choose **Unmerge Devices**.

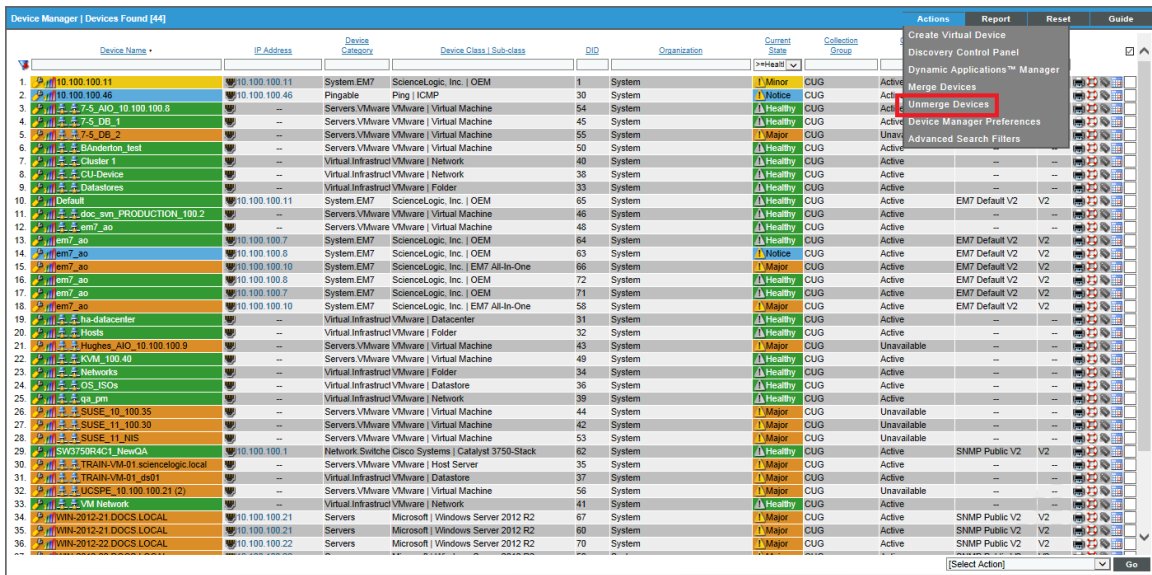

3. The **Device Bulk Unmerge** page displays a list of merged devices. Each numbered row indicates a pair of merged devices that can be unmerged. Select the checkboxes in the last column of each row of devices that you want to unmerge, then select the **[Unmerge]** button.

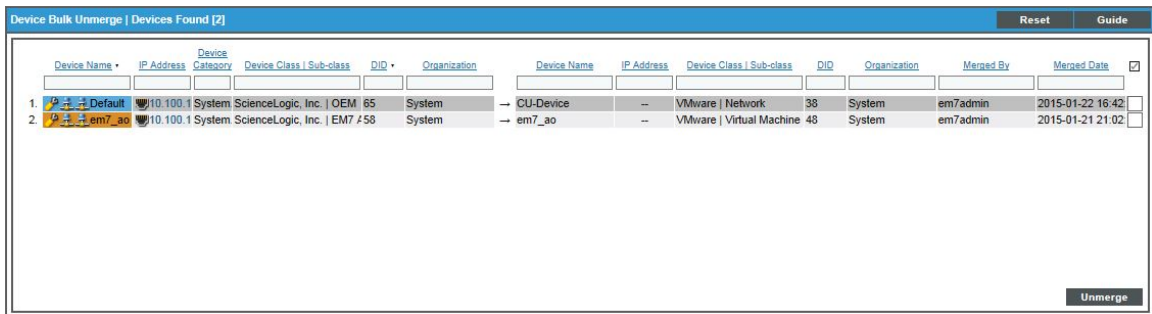

4. A modal window displays that asks you to confirm the unmerging. Select the **[Unmerge]** button.

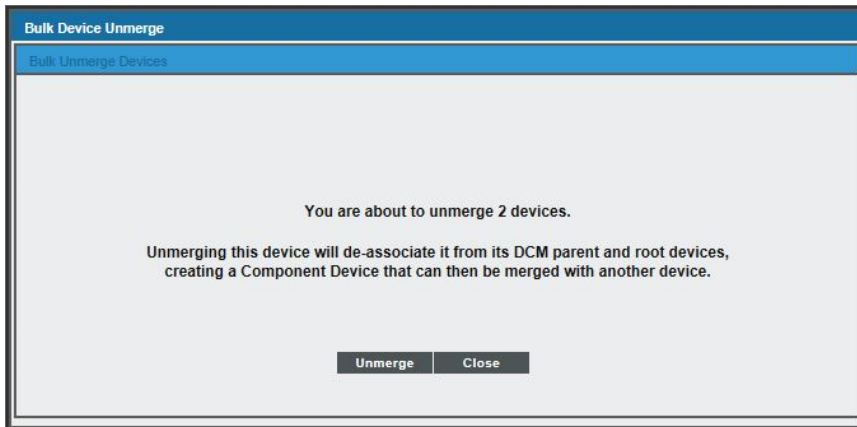

5. When the message, "Device Bulk Unmerge complete" displays, select the **[Close/Esc]** button.

**NOTE:** To view an updated list of devices that includes your unmerged devices, select the **[Reset]** button on the **Device Manager** page.

---

# Chapter

# 5



## Managing a Single Device with the Device Administration Panel

---

### Overview

This chapter describes how to use the Device Administration Panel in SL1.

Use the following menu options to navigate the SL1 user interface:

- To view a pop-out list of menu options, click the menu icon (.
- To view a page containing all of the menu options, click the Advanced menu icon (  ).

This chapter includes the following topics:

<i>What is the Device Administration Panel?</i> .....	88
<i>Actions Menu</i> .....	90
<i>Device Properties</i> .....	94
<i>Viewing Read-Only Information About the Device</i> .....	95
<i>Editing Device Settings</i> .....	96
<i>Identification</i> .....	97
<i>Monitoring &amp; Management</i> .....	97
<i>Preferences</i> .....	101
<i>Adding an IP Address to a Device</i> .....	102
<i>Removing an IP Address from a Device</i> .....	104
<i>Managing Device IPs</i> .....	105
<i>Clearing the Device Cache</i> .....	108

- Aligning a Secondary Credential ..... 109
- Adding the Device to a Device Group ..... 112
- Creating a Ticket About the Device ..... 114
- Adding a Note to a Device ..... 116
- Aligning Custom Attributes with a Device ..... 119
  - Creating a New Extended Custom Attribute ..... 120
  - Deleting an Extended Custom Attribute from a Device ..... 122
- Associating a Product SKU with the Device ..... 123
- Merging Devices ..... 124
  - Merging Individual Devices ..... 125
  - Unmerging Individual Devices ..... 127
- Performing Administrative Tasks for One or More Devices ..... 129
- Shortcut Keys for Device Administration panel ..... 130

## What is the Device Administration Panel?

The **Device Administration** panel allows you to define how SL1 will interact with a device. This includes defining the data that will be retrieved, the frequency with which SL1 will poll the device, and policies and thresholds that will generate events for the device.

To access the **Device Administration** panel for a device:

1. Go to the **Device Manager** page (Devices > Device Manager).

Device Name	Device Hostname	IP Address	Device Class	Device Class / Subclass	CID	Organization	Current State	Collocate Group	Collection Rate	SNMP Credential	Report	Reset	Queue
10.100.100.40	...	10.100.100.40	Pinable	FreeBSD / ICMP	274	System	Healthy	CUG	...	User-Disabled	...	...	...
10.100.100.46	...	10.100.100.46	Pinable	FreeBSD / ICMP	294	John	CUG	...	...	User-Disabled	...	...	...
10.10.7.11.186	...	...	Network App FS Networks, Inc.	BIG-PLTM Node	2779	System	Healthy	CUG	Active	SNMP Public V2	V2	...	...
10.10.7.11.186	...	...	Network App FS Networks, Inc.	BIG-PLTM Node	2193	System	Healthy	CUG	Active	SNMP Public V2	V2	...	...
10.10.7.11.186	...	...	Network App FS Networks, Inc.	BIG-PLTM Node	2228	System	Notice	CUG	Active	SNMP Public V2	V2	...	...
10.10.7.11.186	...	...	Network App FS Networks, Inc.	BIG-PLTM Node	1430	System	Healthy	CUG	Active	SNMP Public V2	V2	...	...
10.10.7.11.186	...	...	Network App FS Networks, Inc.	BIG-PLTM Node	1204	System	Healthy	CUG	Active	SNMP Public V2	V2	...	...
10.10.7.11.186	...	...	Network App FS Networks, Inc.	BIG-PLTM Node	1951	System	Healthy	CUG	Active	SNMP Public V2	V2	...	...
10.10.7.11.187	...	...	Network App FS Networks, Inc.	BIG-PLTM Node	2486	System	Healthy	CUG	Active	SNMP Public V2	V2	...	...
10.10.7.11.187	...	...	Network App FS Networks, Inc.	BIG-PLTM Node	2391	System	Healthy	CUG	Active	SNMP Public V2	V2	...	...
10.10.7.11.187	...	...	Network App FS Networks, Inc.	BIG-PLTM Node	2840	System	Healthy	CUG	Active	SNMP Public V2	V2	...	...
10.10.7.11.187	...	...	Network App FS Networks, Inc.	BIG-PLTM Node	1952	System	Healthy	CUG	Active	SNMP Public V2	V2	...	...
10.10.7.11.187	...	...	Network App FS Networks, Inc.	BIG-PLTM Node	1206	System	Healthy	CUG	Active	SNMP Public V2	V2	...	...
10.10.7.11.187	...	...	Network App FS Networks, Inc.	BIG-PLTM Node	1431	System	Healthy	CUG	Active	SNMP Public V2	V2	...	...
10.10.7.11.187	...	...	Network App FS Networks, Inc.	BIG-PLTM Node	2080	System	Healthy	CUG	Active	SNMP Public V2	V2	...	...
10.10.7.11.189	...	...	Network App FS Networks, Inc.	BIG-PLTM Node	2002	System	Notice	CUG	Active	SNMP Public V2	V2	...	...
10.10.7.11.189	...	...	Network App FS Networks, Inc.	BIG-PLTM Node	1058	System	Notice	CUG	Active	SNMP Public V2	V2	...	...
10.10.7.11.189	...	...	Network App FS Networks, Inc.	BIG-PLTM Node	2102	System	Healthy	CUG	Active	SNMP Public V2	V2	...	...
10.10.7.11.189	...	...	Network App FS Networks, Inc.	BIG-PLTM Node	1931	System	Healthy	CUG	Active	SNMP Public V2	V2	...	...
10.10.7.11.189	...	...	Network App FS Networks, Inc.	BIG-PLTM Node	855	System	Healthy	CUG	Active	SNMP Public V2	V2	...	...
10.10.7.11.189	...	...	Network App FS Networks, Inc.	BIG-PLTM Node	2032	System	Notice	CUG	Active	SNMP Public V2	V2	...	...
10.10.7.11.237	...	...	Network App FS Networks, Inc.	BIG-PLTM Node	1423	System	Healthy	CUG	Active	SNMP Public V2	V2	...	...
10.7.12.125	...	...	Network App FS Networks, Inc.	BIG-PLTM Node	2333	System	Notice	CUG	Active	SNMP Public V2	V2	...	...
10.7.12.125	...	...	Network App FS Networks, Inc.	BIG-PLTM Node	2179	System	Healthy	CUG	Active	SNMP Public V2	V2	...	...
10.7.12.125	...	...	Network App FS Networks, Inc.	BIG-PLTM Node	2138	System	Healthy	CUG	Active	SNMP Public V2	V2	...	...
10.7.12.125	...	...	Network App FS Networks, Inc.	BIG-PLTM Node	2714	System	Healthy	CUG	Active	SNMP Public V2	V2	...	...
10.7.12.125	...	...	Network App FS Networks, Inc.	BIG-PLTM Node	2681	System	Healthy	CUG	Active	SNMP Public V2	V2	...	...
10.7.12.125	...	...	Network App FS Networks, Inc.	BIG-PLTM Node	1979	System	Healthy	CUG	Active	SNMP Public V2	V2	...	...
10.7.12.125	...	...	Network App FS Networks, Inc.	BIG-PLTM Node	2429	System	Healthy	CUG	Active	SNMP Public V2	V2	...	...
10.7.12.125	...	...	Network App FS Networks, Inc.	BIG-PLTM Node	2291	System	Healthy	CUG	Active	SNMP Public V2	V2	...	...
10.7.12.125	...	...	Network App FS Networks, Inc.	BIG-PLTM Node	2441	System	Healthy	CUG	Active	SNMP Public V2	V2	...	...
10.7.12.125	...	...	Network App FS Networks, Inc.	BIG-PLTM Node	2062	System	Healthy	CUG	Active	SNMP Public V2	V2	...	...
10.7.12.125	...	...	Network App FS Networks, Inc.	BIG-PLTM Node	2371	System	Healthy	CUG	Active	SNMP Public V2	V2	...	...
10.7.12.125	...	...	Network App FS Networks, Inc.	BIG-PLTM Node	2754	System	Healthy	CUG	Active	SNMP Public V2	V2	...	...
10.7.12.125	...	...	Network App FS Networks, Inc.	BIG-PLTM Node	2878	System	Notice	CUG	Active	SNMP Public V2	V2	...	...
10.7.12.125	...	...	Network App FS Networks, Inc.	BIG-PLTM Node	3053	System	Healthy	CUG	Active	SNMP Public V2	V2	...	...
10.7.12.125	...	...	Network App FS Networks, Inc.	BIG-PLTM Node	2115	System	Healthy	CUG	Active	SNMP Public V2	V2	...	...
10.7.12.125	...	...	Network App FS Networks, Inc.	BIG-PLTM Node	1008	System	Healthy	CUG	Active	SNMP Public V2	V2	...	...
10.7.12.125	...	...	Network App FS Networks, Inc.	BIG-PLTM Node	2389	System	Healthy	CUG	Active	SNMP Public V2	V2	...	...
10.7.12.125	...	...	Network App FS Networks, Inc.	BIG-PLTM Node	2790	System	Healthy	CUG	Active	SNMP Public V2	V2	...	...
10.7.12.125	...	...	Network App FS Networks, Inc.	BIG-PLTM Node	2842	System	Notice	CUG	Active	SNMP Public V2	V2	...	...
10.7.12.125	...	...	Network App FS Networks, Inc.	BIG-PLTM Node	3208	System	Healthy	CUG	Active	SNMP Public V2	V2	...	...
10.7.12.125	...	...	Network App FS Networks, Inc.	BIG-PLTM Node	2385	System	Notice	CUG	Active	SNMP Public V2	V2	...	...



- In the **Device Manager** page, find the device for which you want to access the **Device Administration** panel. Select its wrench icon (🔧). The **Device Properties** page is displayed. From this page, you can access all the pages in the **Device Administration** panel.
- The **Device Administration** tools include the following tabs and pages:

The screenshot displays the 'Device Properties' page for a device named 'em7\_ao'. At the top, there are navigation tabs: Close, Properties (selected), Thresholds, Collections, Monitors, Schedule, and Logs. Below these are sub-tabs: Tool box, Interfaces, Relationships, Tickets, Redirects, Notes, and Attributes. The main content area is divided into several sections:

- Device Information:** Fields for Device Name (em7\_ao), IP Address (10.100.100.7 | 677), Class (ScienceLogic, Inc.), Organization (System), Collection Mode (Unavailable), Description (ScienceLogic EM7 G3 - All-In-One), Device Hostname, Managed Type (Physical Device), Category (System EM7), Sub-Class (OEM), Uptime (5 days, 02:06:30), Collection Time (2015-08-26 11:00:00), and Group / Collector (CUG | em7\_ao).
- Device Properties:** A blue header with 'Organization' and 'Asset' dropdowns, and 'Actions', 'Reset', and 'Guide' buttons.
- Identification:** Fields for Device Name (em7\_ao), IP Address ([10.100.100.7 - verified]), and Organization ([System]).
- Monitoring & Management:** A large section with various settings:
  - Device Class: ScienceLogic, Inc. OEM
  - SNMP Read/Write: [EM7 Default V2] / [None]
  - Availability Port: [UDP] / [161 - SNMP]
  - Latency Port: [ICMP] / [ICMP]
  - Avail+Latency Alert: [Disable]
  - User Maintenance: [Disabled] / [Maintenance Collection Enabled]
  - Collection: [Enabled] / [CUG]
  - Coll. Type: [Standard]
  - Critical Ping: [Disabled]
  - Dashboard: [None]
  - Event Mask: [Group in blocks every 10 minutes]
- Preferences:** A sidebar with checkboxes:
  - Auto-Clear Events:
  - Accept All Logs:
  - Daily Port Scans:
  - Auto-Update:
  - Scan All IP's:
  - Dynamic Discovery:
  - Preserve Hostname:
  - Disable Asset Update:
  - Bypass Interface Inventory:

Tab	Description
Properties	In the <b>Device Properties</b> page, you can edit parameters that affect how SL1 "sees" the device and monitors the device.
Thresholds	The <b>Device Thresholds</b> page allows you to define usage and performance thresholds and data retention thresholds for a device. When these thresholds are exceeded, SL1 will generate an event for the device.
Collections	<p>The <b>Dynamic Application Collections</b> page displays all the Dynamic Applications associated with the device. For Dynamic Applications of type "performance," the page displays report policies for each Dynamic Application. For Dynamic Applications of type "configuration," the page displays objects monitored by each Dynamic Application.</p> <p>You can specify a credential for use with the Dynamic Application for the specific device only.</p> <p>You can enable or disable one or more report policies for the specific device only.</p> <p>You can enable or disable monitoring of one or more objects for the specific device only.</p>

Tab	Description
Monitors	<p>The <b>Monitoring Policies</b> page allows you to define monitoring policies for a device.</p> <p>The <b>Monitoring Policies</b> page allows you to define policies that monitor: system processes, domain-name availability and lookup speed, email round-trip speed, SOAP and XML transaction speeds, TCP/IP port availability, web-content availability, and Windows services.</p> <div style="border: 1px solid black; padding: 5px; margin-top: 10px;"> <p><b>NOTE:</b> All these monitoring policies can generate events. SL1 uses the data collected by these policies to create performance reports and graphs.</p> </div>
Schedule	In the <b>Maintenance Schedule</b> page you can view, edit, and schedule downtimes for the device.
Logs	The <b>Device Logs &amp; Messages</b> page displays all the messages SL1 has collected from the device and from SL1 about the device.
Toolbox	The <b>Device Toolbox</b> page provides access to common network tools. The list of tools available depends upon the type of device and the configuration of the device. This page allows you to access and run diagnostics on a device without leaving the user interface session.
Interfaces	The <b>Device Interfaces</b> page displays detailed information about each network interface on the device. From this page, you can view details about each individual interface and define bandwidth monitoring for the interface.
Relationships	The <b>Device Relationships</b> page displays information about parent-child relationships between devices. From this page, you can view details on the relationships between on layer-2 and layer-3 devices, hypervisors and their virtual machines, and other relationships.
Tickets	The <b>Ticket History</b> page displays all tickets associated with the device. This page displays critical information about each ticket. If you require more detail, you can access the <b>Ticket Editor</b> from this page.
Redirects	The <b>Redirection</b> page appears only for virtual devices. This page allows you to redirect logs entries from an IP-based device to a virtual device.
Notes	The <b>Notes &amp; Attachments</b> page displays a list of all comments and attachments associated with the device properties. When you select the <i>Notepad Editor</i> option in the <b>Device Properties</b> page, the notes appear in this page.
Attributes	The <b>Attributes</b> page displays a list of custom attributes that are already aligned with the device. Additionally, the <b>Attributes</b> page enables you to assign a value to those custom attributes, create and align a new extended custom attribute with the device, or delete a custom attribute from a device.

## Actions Menu

The pages in the **Device Administration** panel each include the **[Actions]** menu. The **[Actions]** menu allows you to perform many device-related tasks without requiring you to leave the current page. The **[Actions]** menu looks like a button and is located in the upper right of the page.

Close	Properties	Thresholds	Collections	Monitors	Schedule	Logs
Togbox	Interfaces	Relationships	Tickets	Redirects	Notes	Attributes
Device Name	em7_ao	Managed Type	Physical Device			
IP Address / ID	10.100.100.7   677	Category	System.EM7			
Class	ScienceLogic, Inc.	Sub-Class	OEM			
Organization	System	Uptime	5 days, 02:06:30			
Collection Mode	Unavailable	Collection Time	2015-08-26 11:00:00			
Description	ScienceLogic EM7 G3 - All-In-One	Group / Collector	CUG   em7_ao			
Device Hostname						
Device Properties						
						<a href="#">Actions</a>
						<a href="#">Reset</a>
						<a href="#">Asset</a>
						<a href="#">Guide</a>
Identification						
Device Name	em7_ao	IP Address	[10.100.100.7 - verified]	Organization	[System]	
Monitoring & Management						
Device Class	ScienceLogic, Inc. OEM					
SNMP Read/Write	[EM7 Default V2]	[None]				
Availability Port	[UDP]	[161 - SNMP]				
Latency Port	[ICMP]	[ICMP]				
Avail+Latency Alert	[Disable]					
User Maintenance	[Disabled]	[Maintenance Collection Enabled]				
Collection	[Enabled]	[CUG]				
Coll. Type	[Standard]					
Critical Ping	[Disabled]					
Dashboard	[None]					
Event Mask	[Group in blocks every 10 minutes]					
<input type="button" value="Save"/>						
Preferences						
Auto-Clear Events	<input checked="" type="checkbox"/>					
Accept All Logs	<input checked="" type="checkbox"/>					
Daily Port Scans	<input checked="" type="checkbox"/>					
Auto-Update	<input checked="" type="checkbox"/>					
Scan All IP's	<input type="checkbox"/>					
Dynamic Discovery	<input checked="" type="checkbox"/>					
Preserve Hostname	<input checked="" type="checkbox"/>					
Disable Asset Update	<input type="checkbox"/>					
Bypass Interface Inventory	<input type="checkbox"/>					

The following entries in the **[Actions]** menu appear only in the **Device Properties** page:

- **Add IP Address.** Leads to the **Add IP Address** modal page, where you can define an additional IP address for the device. SL1 will continue to use the primary IP Address for communication with the device. For details, see the section on [Adding an IP Address to a Device](#).
- **Select Primary IP Addresses.** Leads to the **Select Primary IP Addresses** modal page, where you can define primary IP addresses and secondary IP addresses for the device. A primary IP address allows SL1 to align traps and syslog messages with the device. In the case of duplicate primary IP addresses, you can promote a secondary IP address to a primary IP address and demote the duplicated primary IP address.
- **Clear Device Cache.** Selecting this option clears data about this device from the cache. For details, see the section on [Clearing the Device Cache](#).
- **Device Class.** Leads to the **Device Class** modal page, where you can select a device class to associate with the device. For details, see the section on [Device Classes and Device Categories](#).
- **Secondary Credentials.** Leads to the **Secondary Credentials** modal page, where you can associate additional credentials with the device. SL1 will then use the primary credential and the additional credentials during discovery for the device. For details, see the section on [Aligning a Secondary Credential](#).

- **Merge Device.** Allows you to merge the data from a component device and a physical device into a single record. When you merge a physical device and a component device, the device record for the component device is no longer displayed in the user interface; the device record for the physical device is displayed in user interface pages that previously displayed the component device. For example, the physical device is displayed instead of the component device in the **Device Components** page and the **Component Map** page. All existing and future data for both devices will be associated with the physical device.
  - For *physical devices*, this option leads to the **Merge Devices** modal page, where you can view a list of component devices and select a component device to merge with the current physical device.
  - For *component devices*, this option leads to the **Merge Devices** modal page, where you can view a list of physical devices and select a physical device to merge with the current component device.

For details, see the section on [Merging Devices](#).

- **Unmerge Device.** Appears only in the **Device Properties** page for physical devices. Prompts you to unmerge the component device that has been previously merged with the physical device. For details, see the section on [Merging Devices](#).

**NOTE:** You can merge only one component device with a physical device.

**NOTE:** When you merge two devices, the historical device logs for those devices will be merged and are not unmerged when the **Unmerge Device** option is used.

**NOTE:** In Dashboard widgets, merged devices can be searched for and filtered by the device class or device category of the physical device or the device class or device category of the component device. If both device classes or device categories are selected, a merged device will appear twice in a single widget.

**NOTE:** When you merge two devices, active events associated with the component device will be set to "cleared". The cleared events will not be associated with the physical device. If the devices are unmerged, the cleared events cannot be moved back to the component device.

The following entry in the **[Actions]** menu appears only in the **Device Logs & Messages** page:

- **Export Logs.** Allows you to export the log entries to a file on your local computer. You can save the exported file or save and view the exported file.

The following entries in the **[Actions]** menu appear on each page in the **Device Administration** panel:

- **My Bookmarks.** Displays the **Administer Bookmarks** modal page, where you can access pre-defined bookmarks or save a new bookmark. For details, see the manual [Customizing User Experience](#).

- **Create a Ticket.** Leads to the **Ticket Editor** page, where you can define a new ticket about the device. For details, see the section on [Creating a Ticket About the Device](#).
- **Custom Navigation.** Leads to the **Custom Navigation** modal page, where you can define a custom tab for the device administration panel for the current device. The custom tab will contain a link to an outside URL. For details, see the section on [Customizing the Interface for a Device](#).
- **Device Children.** Leads to the **Device Children** modal page, where you can add children devices to the current device. The current device will be the parent device. For details, see the section on [Defining Device Relationships](#).
- **Device Groups.** Leads to the **Device Groups** modal page, where you can assign the device to a device group or remove a device from a device group. For details, see the section on [Adding a Device to a Device Group](#).
- **Notepad Editor.** Leads to the **Notepad Editor** modal page, where you can enter a note to include with the device. The note will appear in the **Notes & Attachments** page for the device. For details, see the section on [Adding a Note to a Device](#).
- **Product Catalog.** Leads to the **Product Catalog** modal page, where you can associate a product SKU with the device or disassociate the device from a product SKU. For details, see the section on [Associating a Product SKU with a Device](#).
- **Report Creator.** Leads to the **Report Creator** modal page, where you can define a device report, including the information to include in the report and the format in which to generate the report. For details, see the section on [Generating a Report for a Single Device](#).
- **Resource Usage.** Leads to the **Resource Usage** modal page, where you can view the list of device logs and device statistics gathered by SL1 and also view where the data is stored and how many bytes of data are being stored.

## Device Properties

The **Device Properties** page allows you to view basic, read-only information about a device and also to view and edit the device's parameters for discovery (collection).

The settings defined for the device in the **Device Properties** page override any system-wide settings.

Close	Properties	Thresholds	Collections	Monitors	Schedule	Logs		
Toolbox	Interfaces	Relationships	Tickets	Redirects	Notes	Attributes		
Device Name	em7_ao	Managed Type	Physical Device					
IP Address / ID	10.100.100.7   677	Category	System EM7					
Class	ScienceLogic, Inc.	Sub-Class	OEM					
Organization	System	Uptime	5 days, 02:06:30					
Collection Mode	Unavailable	Collection Time	2015-08-26 11:00:00					
Description	ScienceLogic EM7 G3 - All-In-One	Group / Collector	CUG   em7_ao					
Device Hostname								
<b>Device Properties</b>								
						Organization	Asset	
						Actions	Reset	Guide
<b>Identification</b>								
Device Name		IP Address		Organization				
em7_ao		[10.100.100.7 - verified]		[System]				
<b>Monitoring &amp; Management</b>								
Device Class: ScienceLogic, Inc. OEM								
SNMP Read/Write: [EM7 Default V2] [None]								
Availability Port: [UDP] [161 - SNMP]								
Latency Port: [ICMP] [ICMP]								
Avail+Latency Alert: [Disable]								
User Maintenance: [Disabled] [Maintenance Collection Enabled]								
Collection: [Enabled] [CUG]								
Coll. Type: [Standard]								
Critical Ping: [Disabled]								
Dashboard: [None]								
Event Mask: [Group in blocks every 10 minutes]								
<b>Save</b>								
<b>Preferences</b>								
Auto-Clear Events <input checked="" type="checkbox"/>								
Accept All Logs <input checked="" type="checkbox"/>								
Daily Port Scans <input checked="" type="checkbox"/>								
Auto-Update <input checked="" type="checkbox"/>								
Scan All IP's <input type="checkbox"/>								
Dynamic Discovery <input checked="" type="checkbox"/>								
Preserve Hostname <input checked="" type="checkbox"/>								
Disable Asset Update <input type="checkbox"/>								
Bypass Interface Inventory <input type="checkbox"/>								

From the **Device Properties** page, you can:

- **View Information about the Device.** This is described in the section on [Read-Only Information about the Device](#).
- **Edit the Discovery Parameters for the Device.** This is described in the section on [Editing Device Settings](#).
- **Edit the Device Class for the Device.** This is described in the section on [Device Classes](#).
- **Associate an Additional IP Address with the Device.** This is described in the section on [Adding an IP Address to a Device](#).
- **Remove an IP Address from the Device.** This is described in the section on [Removing an IP Address from a Device](#).
- **Manage Primary and Secondary IP Addresses for the Device.** This is described in the section on [Managing Device IPs](#).

- **Clear the Device Cache.** This is described in the section on [Clearing the Device Cache](#).
- **Define Child Devices.** This is described in the section on [Defining Device Relationships](#).
- **Associate a Secondary Credential with the Device.** This is described in the section on [Aligning a Secondary Credential](#).
- **Add the Device to a Device Group.** This is described in the section [Adding the Device to a Device Group](#).
- **Create a Ticket About the Device.** This is described in the section [Creating a Ticket About the Device](#).
- **Define Custom Navigation for the Device.** This is described in the section [Customizing the User Interface for a Device](#).
- **Add a Note to the Device.** This is described in the section [Adding a Note to a Device](#).
- **Associate a Product SKU with the Device.** This is described in the section [Associating a Product SKU with the Device](#).
- **Create or Edit an Asset Record for the Device.** This is described in the **Asset Management** manual.
- **View Resource Usage for the Device.** This is described in the manual **Monitoring Device Infrastructure Health**.
- **Create a Report About the Device.** This is described in the manual **Monitoring Device Infrastructure Health**.

## Viewing Read-Only Information About the Device

Each page in the **Device Administration** panel and the **Device Reports** panel displays the following read-only information about the device:

The screenshot displays the 'Device Properties' page for a device named 'em7\_a0'. The interface is divided into several sections:

- Properties Summary:** A table at the top provides key details:
 

Device Name	em7_a0	Managed Type	Physical Device
IP Address / ID	10.100.100.7   677	Category	System EM7
Class	ScienceLogic, Inc.	Sub-Class	OEM
Organization	System	Uptime	5 days, 02:06:30
Collection Mode	Unavailable	Collection Time	2015-08-26 11:00:00
Description	ScienceLogic EM7 G3 - All-In-One	Group / Collector	CUG   em7_a0
Device Hostname			
- Identification:** Fields for Device Name (em7\_a0), IP Address ([10.100.100.7 - verified]), and Organization ([System]).
- Monitoring & Management:** A large section with various configuration options:
  - Device Class: ScienceLogic, Inc. OEM
  - SNMP Read/Write: [EM7 Default V2] / [None]
  - Availability Port: [UDP] / [161 - SNMP]
  - Latency Port: [ICMP] / [ICMP]
  - Avail-Latency Alert: [Disable]
  - User Maintenance: [Disabled] / [Maintenance Collection Enabled]
  - Collection: [Enabled] / [CUG]
  - Coil Type: [Standard]
  - Critical Ping: [Disabled]
  - Dashboard: [None]
  - Event Mask: [Group in blocks every 10 minutes]
- Preferences:** A sidebar on the right with several checked options:
  - Auto-Clear Events
  - Accept All Logs
  - Daily Port Scans
  - Auto-Update
  - Scan All IPs
  - Dynamic Discovery
  - Preserve Hostname
  - Disable Asset Update
  - Bypass Interface Inventory

- **Device Name**. Name of the device. Clicking on this field displays the **Device Properties** page for the device.
- **IP Address /ID**. IP address of the device and the device ID of the device. The device ID is a unique numeric identifier, automatically assigned to the device by SL1. Clicking on this field displays the **Device Properties** page for the device.
- **Class**. Device class for the device. A [device class](#) usually describes the manufacturer of the device.
- **Organization**. Organization associated with the device. Clicking on this field leads to the **Organizational Summary** page for the device's organization.
- **Collection Mode**. Collection mode. Choices are "active", meaning SL1 is periodically collecting data from the device, or "inactive", meaning the SL1 is not currently collecting data from the device. Clicking on this field executes the Remote Port Scanner and displays the **Remote Port Scanner** modal page.
- **Description**. For SNMP devices, the SysDescr value as reported by the SNMP agent on the device. If a device does not support SNMP, this field appears blank.
- **Root Device**. For component devices, displays the device name or IP address of the physical device where the system that manages the device resides. Clicking on this value displays the **Device Properties** page for the root device.
- **Parent Device**. For component devices, displays the device name or IP address of the parent device. The parent device can be either another component device or a physical device. A parent device is the device between the current component device and the next layer in the component-device hierarchy. Clicking on this value displays the **Device Properties** page for the parent device.
- **Device Hostname**. For devices that are discovered and managed by hostname (instead of IP address), this field displays the fully qualified hostname for the device.
- **Managed Type**. Specifies the protocol used to discover the device and whether or not the device is a physical device or a virtual device. Clicking on this field executes an SNMP walk of the device's SNMP file and displays the **SNMP Walker** modal page.
- **Category**. The device category associated with the device. The [device category](#) usually describes the function of the hardware.
- **Sub-Class**. The device sub-class associated with the device. The sub-class usually described the model of a device.
- **Uptime**. The number of days, hours, minutes, and seconds that the device has been continuously up and communicating with SL1. Clicking on this field displays the System Vitals Summary report.
- **Collection Time**. The date and time that SL1 last collected data from the device.
- **Group/Collector**. The Collector Group and specific collector used to last collect data from the device. For All-In-One Appliances, this field will contain the name of the default, built-in Collector Group.

---

## Editing Device Settings

The fields in the **Device Properties** page affect how SL1 will discover and collect information about the device. Initially, SL1 uses system defaults, system-wide settings, and data retrieved during initial discovery of the device to populate these fields.





You can edit one or more of these fields for the device. The settings defined for the device in the **Device Properties** page override any system-wide settings (defined in the pages under System > Settings).

## Identification

- **Device Name.** The name of the device. If possible, SL1 retrieves the device name from the device. If the device is running SNMP or has a DNS entry, the name will be retrieved directly from the device. You can set the precedence for which of these names are used (SNMP system name or DNS entry) in the **Behavior Settings** page (System > Settings > Behavior). You can edit this name in the **Device Properties** page; however, the Device Name will not be changed on the actual device.
- **IP Address.** The IP address that SL1 uses to communicate with the device. You can add additional IP addresses for the device. To change the IP address SL1 uses to communicate with the device (called the **admin primary** address), select a different IP address in this field.
- **Organization.** Organization to which this device has been assigned. To assign this device to a different Organization, select an Organization from the drop-down list. To view details about the assigned organization, select the people icon () to the right of this field.

## Monitoring & Management

- **Device Class.** Displays the **Device Class**. To assign a different device class to the device, select the toolbox icon () to the right of this field. To edit the device's Device Class, select the pencil icon () to the right of this field.

**NOTE:** If you incorrectly change a device's Device Class, SL1's nightly update will override the new Device Class and assign the device to the correct Device Class.

- **SNMP Read.** The community string for read-only access to SNMP information on the device. The community string is a password that allows SL1 to gather SNMP information from the device. If this device has been aligned with a credential to which you do not have access, this field will display the value *Restricted Credential*. If you align the device with a different credential, the entry for *Restricted Credential* will be removed from the list in this field; you will not be able to re-align the device with the *Restricted Credential*.
- **SNMP Write.** The community string for read-and-write access to SNMP information on the device. The community string is a password that allows SL1 to gather SNMP information from the device and send SNMP information to the device. If this device has been aligned with a credential to which you do not have access, this field will display the value *Restricted Credential*. If you align the device with a different credential, the entry for *Restricted Credential* will be removed from the list in this field; you will not be able to re-align the device with the *Restricted Credential*.

**NOTE:** Devices that do not support SNMP ("pingable" devices) display the value *None* in both the **SNMP Read** field and the **SNMP Write** field.

**NOTE:** Your organization membership(s) might affect the list of credentials you can see in the **SNMP Read** field and the **SNMP Write** field. For details, see the **Discovery and Credentials** manual.

- **Availability Port.** Specifies the protocol and specific port SL1 should monitor to determine if the device is available. The list of ports will contain all the ports discovered by SL1 and the options *ICMP* and *SL1 agent*. For the *ICMP* option, SL1 performs a ping request. The data collected from this port or ping request will be used in device availability reports. The *SL1 agent* option allows you to specify that the platform should use information collected by the agent to determine port availability. The agent must be installed on the device to use this option.
  - If you select *ICMP* as the protocol, you can use the **ICMP Availability Thresholds** in the [Device Thresholds](#) page to further define how SL1 will test the device's availability.

**NOTE:** Component Devices use a Dynamic Application collection object to measure availability. For details, see the description of the **Component Identifier** field in the **Collection Objects** page. For details, see the manual **Monitoring Device Infrastructure Health**.

- **Run Availability Policy** (  ). When you select this icon, SL1 immediately checks the availability of the device, using the port and protocol specified in the **Availability Port** fields. SL1 displays a **Session Logs** modal page that displays a detailed description of each step of the availability policy. This information is helpful when troubleshooting availability problems with a device.

- **Latency Port.** Specifies the protocol and specific port SL1 should monitor to determine latency for the device. The list of ports will contain all the ports discovered by SL1 and the option *ICMP*, for which SL1 performs a ping request. The data collected from this port or ping request will be used in device latency reports.
  - If you select *ICMP* as the protocol, you can use the **ICMP Availability Thresholds** in the [Device Thresholds](#) page to further define how SL1 will test the device's latency.
- **Avail + Latency Alert.** Specifies how SL1 should respond when the device fails an availability check, when the device fails a latency check, and when the device fails both. These options allow you to create separate events when SNMP fails on a device and when a device is not up and running. Choices are:
  - *Enabled.* SL1 will create the following events:
    - **If the device fails the availability check,** generates the event "Device Failed Availability Check: UDP - SNMP".
    - **If the device fails the latency check,** generates the event "Network Latency Exceeded Threshold: No Response".
    - **If the device fails both the availability check and the latency check,** generates the event "Device Failed Availability and Latency checks".
  - *Disabled.* SL1 will create the following events:
    - **If the device fails the availability check,** generates the event "Device Failed Availability Check: UDP - SNMP".
    - **If the device fails the latency check,** generates the event "Network Latency Exceeded Threshold: No Response".
    - **If the device fails both the availability check and the latency check,** generates the event "Device Failed Availability Check: UDP - SNMP". The event "Network Latency Exceeded Threshold: No Response" is suppressed under the availability event.
- **User Maintenance.** Specifies whether the device will be put into "user maintenance" mode. By default, when a device is in "user maintenance", SL1 will not generate events about the device.

You can choose to enable or disable polling during "user maintenance" mode. If polling is enabled during "user maintenance", SL1 will collect information from the device but will generate only events of severity less than the severity specified in the system-wide **Maintenance Minimum Severity** setting. For more information about the **Maintenance Minimum Severity** setting, see the [Device Maintenance](#) section.

"User maintenance mode" is not scheduled. That is, a user must manually enable "user maintenance" to put a device into this mode and a user must manually disable "user maintenance" to turn off this mode for a device. "User maintenance mode" overrides scheduled maintenance for a device. Choices are:

- *Enabled.* Device will be set to "user maintenance" mode.
- *Disabled.* Device will not be set to "user maintenance" mode.

- **User Maintenance Collection.** Specifies whether SL1 should poll the device during the "user maintenance". During normal operation, SL1 polls each device as specified by each device's policies and aligned Dynamic Applications. Choices are:
  - *Enabled.* During "user maintenance" mode, SL1 will continue to poll the device.
  - *Disabled.* During "user maintenance" mode, SL1 will not poll the device.
- **Collection State.** Specifies if device will be monitored by SL1. To edit this field, select one of the following from the drop-down list:
  - *Enabled.* Device will be monitored by SL1.
  - *Disabled.* Device will not be monitored by SL1.
- **Collection Poller.** Specifies which Collector Group will perform discovery and gather data from the device. The drop-down list contains a list of available collector groups. For All-In-One Appliances, this field displays only the built-in Collector Group (and any virtual Collector Groups). For details on Collector Groups, see the **System Administration** manual.
- **Coll. Type.** Specifies how SL1 should perform collection. The choices are:
  - *Standard.* SL1 will perform discovery of each device based on the device's IP address. This method is appropriate for devices using standard DNS.
  - *DHCP.* SL1 will perform a DNS lookup for the device each time SL1 retrieves information from the device. This allows SL1 to get the latest IP address for the device.
- **Critical Ping.** Frequency with which SL1 should ping the device in addition to the five minute availability poll. If the device does not respond, SL1 creates an event. The choices are:
  - *Disabled.* SL1 will not ping the device in addition to the five minute availability poll.
  - *Intervals from every 120 seconds - every 5 seconds.*

**NOTE:** SL1 does not use this ping data to create device-availability reports. SL1 will continue to collect device availability data only every five minutes, as specified in the process "Data Collection:Availability" (in the **Process Manager** page). For more details on critical ping, see the manual **Monitoring Device Infrastructure Health**.

**NOTE:** Because high-frequency data pull occurs every 15 seconds, you might experience up to 15 seconds of latency between an unavailable alert and that alert appearing in the Database Server if you set **Critical Ping** to 5 seconds.

**NOTE:** You might experience some performance issues if you have a large number of devices using Internal Collections Dynamic Applications to monitor Critical Availability on a brief polling interval.

- **Dashboard.** Select a device dashboard from a list of all device dashboards in SL1. The selected device dashboard will appear by default in the **Device Summary** page for this device. This field is optional.
- **Event Mask.** Events that occur on a single device within the selected time-interval are grouped together. This allows related events that occur in quick succession on a single device to be rolled-up and posted together, under one event description. Select a time-span from the drop-down list:
  - *Disabled.* SL1 will not group events.
  - *Group in blocks at intervals from every 30 seconds - every 1 month*

By default, when events are masked, the **Events page** displays all events that occur on the device within the specified time-span under a single event, the one with the highest severity. The magnifying-glass icon () appears to the left of the event. When you click on the magnifying-glass icon, the **Suppression Group** modal page is displayed. This page displays details about all events that are masked under the displayed event.

**NOTE:** If an event has **Occurrence Count** and **Occurrence Time** set in its **Event Policy Editor** page, SL1 will use the very first logged occurrence of the event to calculate the **Event Mask**, even if that first occurrence did not appear in the **Events page** (due to the **Occurrence Count** and **Occurrence Time** fields).

For example, suppose an event, *event\_x*, has an **Occurrence Count** of "3" and an **Occurrence Time** of "10 minutes". This means that the event must occur on the same device at least three times within 10 minutes before the event appears in the **Events page**. Suppose the event, *event\_X*, occurs on *device\_A* at 15:51, 15:52, and 15:53. The event will appear in the **Events page** with a timestamp of "15:53", an age of "2 minutes" and a count of "3".

Suppose *device\_A* includes an **Event Mask** of "Group in blocks every 5 minutes". To calculate how to group *event\_x*, the **Event Mask** will use the timestamp of the first occurrence, 15:51, even though the event did not appear in the **Events page** at that time. The **Event Mask** will also use the time of the first occurrence, 15:51, to calculate the "Age/Elapsed" value for the event in the **Suppression Group** modal page.

## Preferences

- **Auto-Clear Events.** Auto Clear automatically removes an event from the Event Monitor if a specified succeeding event occurs. For example, suppose the event "Device not responding to ping" occurs. If the next polling session produces the event "Device now responding normally to ping", the Auto Clear feature could clear the event. If you do not want events to be cleared automatically, uncheck this field. For this specific device, this field overrides the global auto-clear settings in the **Event Policy Editor** page (Events > Event Manager > create or edit).
- **Accept All Logs.** This checkbox specifies whether or not you want to keep and save all logs for this device. If you want to retain only logs associated with events, uncheck this field.
- **Daily Port Scans.** This checkbox specifies whether or not you want SL1 to perform a daily scan of the device for open ports. Select this field to enable daily port scans.

- **Auto-Update.** This checkbox specifies whether or not you want SL1 to perform a nightly discovery of the device and update records with changes to the device. Check this box to enable nightly updates. If this field is unchecked, SL1 will not perform nightly discovery. Changes to the device, including newly opened ports, will not be recorded by SL1.
- **Scan All IPs.** If the device uses multiple IP Addresses, SL1 can scan for open ports on all IPs during nightly discovery. Check this box to enable scanning of all IP Addresses for open ports every night.
- **Dynamic Discovery.** If selected, SL1 will automatically assign the appropriate Dynamic Applications to the device during nightly discovery.
- **Preserve Hostname.** If selected, the name of the device in SL1 will remain the same, even if the name of the actual device is changed. If unselected, the name for the device will be updated if the name of the actual device is changed.
- **Disable Asset Update.** If selected, SL1 will **not** automatically update the asset record associated with the device. For a single device, this checkbox overrides any settings defined in the **Asset Automation** page (System > Settings > Assets).

---

## Adding an IP Address to a Device

If a device has multiple IP addresses, you can add those IP addresses in SL1. SL1 will continue to use the primary IP address for communication with the device. However, after you add an additional IP address to a device, you can change the primary IP address to the new IP address by selecting it in the **IP Address** field.

To define additional IP addresses for a device:

1. Go to the **Device Manager** page (Devices > Device Manager).
2. In the **Device Manager** page, find the device for which you want to define additional IP address. Select the wrench icon () for the device.
3. In the **Device Properties** page, find the **IP Address** field.

- To the right of the **IP Address** field, click on the plus-sign icon (+):

Close	Properties	Thresholds	Collections	Monitors	Schedule	Logs
Toolbox	Interfaces	Relationships	Tickets	Redirects	Notes	Attributes
Device Name	em7_ao	Managed Type	Physical Device			
IP Address / ID	10.100.100.7   677	Category	System EM7			
Class	ScienceLogic, Inc.	Sub-Class	OEM			
Organization	System	Uptime	5 days, 02:06:30			
Collection Mode	Unavailable	Collection Time	2015-08-26 11:00:00			
Description	ScienceLogic EM7 G3 - All-In-One	Group / Collector	CUG   em7_ao			
Device Hostname						

Device Properties		Organization	Asset		
		Actions	Reset	Guide	
<b>Identification</b>					
Device Name	em7_ao	IP Address	[10.100.100.7 - verified] +	Organization	[System]
<b>Monitoring &amp; Management</b>					
Device Class	ScienceLogic, Inc. OEM				
SNMP Read/Write	[EM7 Default V2]	[None]			
Availability Port	[UDP]	[161 - SNMP]			
Latency Port	[ICMP]	[ICMP]			
Avail+Latency Alert	[Disable]				
User Maintenance	[Disabled]	[Maintenance Collection Enabled]			
Collection	[Enabled]	[CUG]			
Coll. Type	[Standard]				
Critical Ping	[Disabled]				
Dashboard	None				
Event Mask	[Group in blocks every 10 minutes]				
<b>Save</b>					
<b>Preferences</b>					
Auto-Clear Events	<input checked="" type="checkbox"/>				
Accept All Logs	<input checked="" type="checkbox"/>				
Daily Port Scans	<input checked="" type="checkbox"/>				
Auto-Update	<input checked="" type="checkbox"/>				
Scan All IP's	<input type="checkbox"/>				
Dynamic Discovery	<input checked="" type="checkbox"/>				
Preserve Hostname	<input checked="" type="checkbox"/>				
Disable Asset Update	<input type="checkbox"/>				
Bypass Interface Inventory	<input type="checkbox"/>				

- Alternately, you can also select the **[Actions]** menu and choose **Add IP Address**.
- The **Add IP Address** modal page appears. The **Add IP Address** modal page allows you to define an additional IP address for the device.

### Add an IP Address

IP Address:

Subnet Mask:

**Add**

7. The **Add IP Address** modal page allows you to define an additional IP address for the device. SL1 will continue to use the Admin Primary IP address for communication with the device. However, SL1 will also collect data about the additional IP address(es). To associate an additional IP address with the device, supply values in the following fields:
  - **IP Address**. Supply the IP address, in standard dotted-decimal format.
  - **Subnet Mask**. Supply the subnet mask associated with the IP address. This field is optional.
8. Select the **[Add]** button.
9. In the **Device Properties** page, you will now see the additional IP address in the **IP Address** field. During auto-discovery, SL1 will verify that this IP address exists on the device and will append the label "verified" to the value in the **IP Address** field.

**NOTE:** After you manually rediscover the device or after SL1 runs nightly auto-discovery (whichever occurs first), the new IP address will appear in the **Network Browser** page.

---

## Removing an IP Address from a Device

If you have added an IP address to a device using the steps in the section on [Associating an Additional IP Address with the Device](#), you can also delete that IP address.

There are two exceptions to this ability:

- You cannot delete an IP address that is currently the **Admin Primary** IP address for the device.
- You cannot delete an IP address that is associated with a network interface.

To delete an IP address:

1. Go to the **Device Manager** page (Devices > Device Manager).
2. In the **Device Manager** page, find the device from which you want to delete an IP address. Select the wrench icon () for the device.
3. In the **Device Properties** page, find the **IP Address** field.



- To the right of the **IP Address** field, select the bomb icon (🧨). The **Remove IP Address** modal page displays:



- Select the checkbox for the IP address you want to delete.
- Select the **[Remove]** button. The IP address is deleted.

**NOTE:** The **Remove IP Address** modal page will display checkboxes only for IP addresses that you can delete. If an IP address appears in the **Remove IP Address** modal page without a checkbox, you cannot delete that IP address.

If an IP address that you want to delete appears in the **Remove IP Address** modal page as *Selected*, it is currently the **Admin Primary** IP address and you must select a new Admin Primary IP before you can delete the IP address. To select a new Admin Primary IP address:

- In the **IP address** drop-down list in the **Device Properties** page, select a new Admin Primary IP address.
- Select the **[Save]** button.
- You can now delete the previous Admin Primary IP address.

---

## Managing Device IPs

There are three types of IP addresses that can be associated with a device:

- Admin Primary.** This is the IP address that SL1 uses to communicate with a device. This IP address is always a primary address and cannot be demoted to a secondary address. You can change the Admin Primary address by changing the value in the **IP Address** field in the **Device Properties** page.
- Primary.** One or more IP addresses that SL1 uses to match incoming log messages (traps and syslog messages) with a device. When you select an IP address in the **Select Primary IP Addresses** modal page, that IP address becomes a primary. You can also unselect an IP address in the **Select Primary IP Addresses** modal page. When you unselect an IP address, that IP address becomes a secondary.
- Secondary.** SL1 gathers information about this IP address, but does not use this IP address to match incoming messages (traps and syslog messages) with a device.

A **Message Collection Server** accepts inbound, asynchronous messages from monitored devices and applications in your network. For example, Message Collectors accept all SNMP traps, SNMP informants, and syslog messages. A SL1 system can include one or more Message Collectors.

- A single Message Collector can be aligned with multiple Collector Groups.

**NOTE:** If you are using a combination Data Collector and Message Collector, this combination appliance should be assigned only to its own dedicated Collector Group and that Collector Group should not include other Data Collectors or Message Collectors.

- Although SL1 will not allow duplicate IP addresses within a single Collector Group, SL1 does allow duplicate IP addresses if each device is aligned with a different Collector Group.
- If a single Message Collector is aligned with multiple Collector Groups, the single Message Collector might be aligned with two or more devices (each in a separate Collector Group) that use the same primary IP address or the same secondary IP address. If this happens, SL1 will generate an event. To fix this situation, you can go to the **Select Primary IP Addresses** modal page for one of the devices and change the primary IP address in question. You can demote the primary and promote a secondary IP address for the device. This will fix the problem with duplicate IPs and allow the Message Collector to align messages with the device.

**NOTE:** For All-In-One Appliances, the function provided by a Message Collector is built in to the All-In-One Appliance. All-In-One systems contain only one built-in Collector Group.

The **Select Primary IP Addresses** modal page allows you to view a list of IP addresses for the device and define one or more of those IP addresses as "primary" or "secondary". To change an IP address to Primary or Secondary, perform the following:

1. Go to the **Device Manager** page (Devices > Device Manager).
2. Find the device for which you want to manage the IP addresses. Select its wrench icon ()

- In the **Device Properties** page for the device, select the **[Actions]** menu. Choose *Select Primary IP Address*.

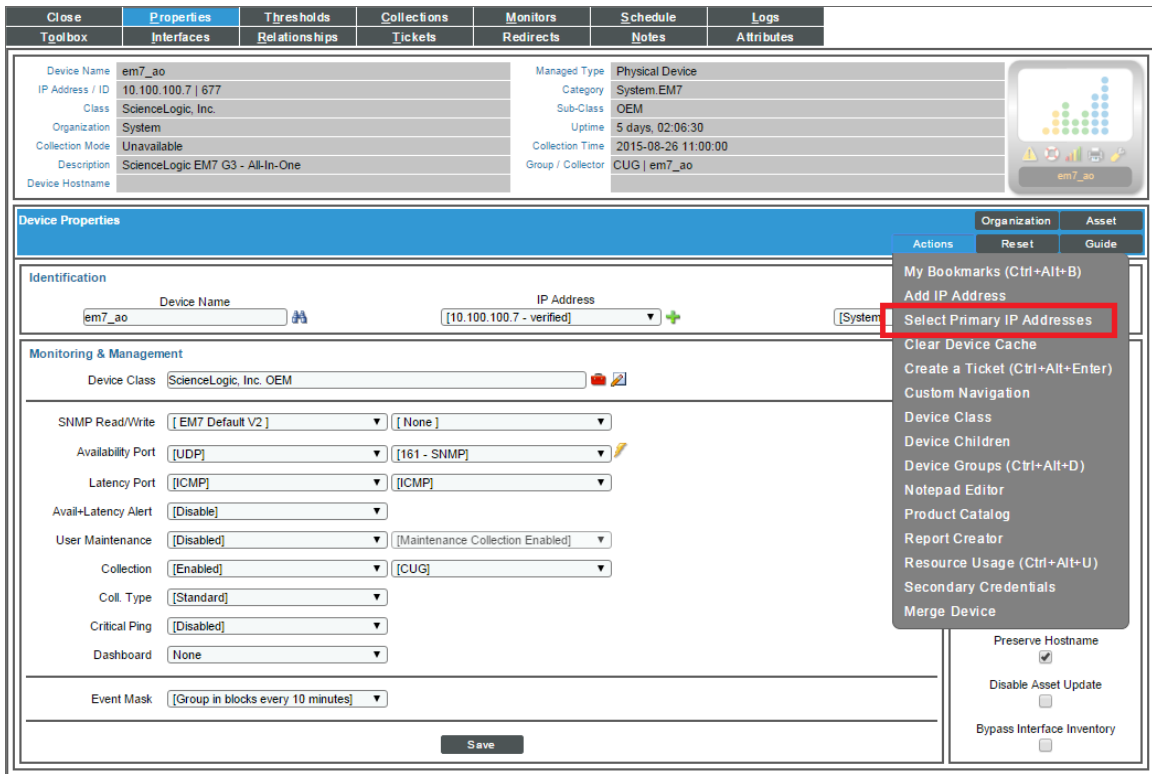

- The **Select Primary IP Addresses** modal page appears. There are three types of IP addresses that can be associated with a device:

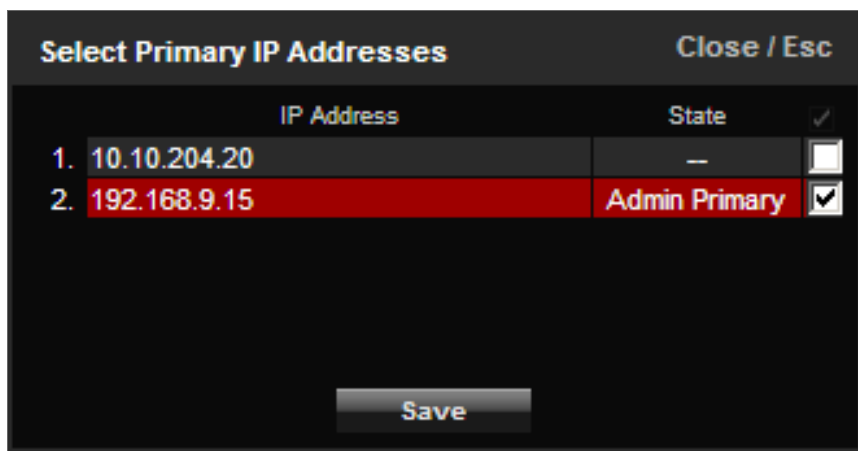

- Admin Primary.** This is the IP address that SL1 uses to communicate with a device. This IP address is always the admin primary address and cannot be demoted to a secondary address.

- **Primary.** One or more IP addresses that SL1 uses to match incoming messages (traps and syslog messages) with a device. When you select an IP address in the Select Primary IP Addresses modal page, that IP address becomes a primary. You can also unselect an IP address in the Select Primary IP Addresses modal. When you unselect an IP address, that IP address becomes a secondary.
- **Secondary.** SL1 gathers information about this IP address, but does not use this IP address to match incoming messages (traps and syslog messages) with a device.

**NOTE:** Within a Collector Group, multiple devices cannot use the same primary IP address. In some circumstances, an IP address appears in the **Select Primary IP Addresses** modal page for the current device but does not have a corresponding checkbox. This means that the IP address is currently used as a primary IP on another device in the same Collector Group. SL1 will not allow you to promote this IP address to a primary IP address on the current device.

5. Select the **[Save]** button to save the changes to the device.

## Clearing the Device Cache

Between HTTP requests, SL1 caches data in memory. For diagnostic purposes, you might want to clear the cached data about a specific device. To do this:

1. Go to the **Device Manager** page (Devices > Device Manager).
2. In the **Device Manager** page, find the device whose data you want to clear from the cache. Select its wrench icon ()

Device Manager   Devices Found [1293]											Actions	Report	Reset	Guide	
Device Name	Device Hostname	IP Address	Device Category	Device Class / Sub-class	DD	Organisation	Current State	Collection Status	Collection State	SNMP Credentials	SNMP Version				
1	10.100.100.40	--	Pingable	Ping   ICMP	274	System	Healthy	CUG	User-Disabled	--	--				
2	10.100.100.46	--	Pingable	FreeBSD   ICMP	294	John	Healthy	CUG	User-Disabled	--	--				
3	10.100.100.108	--	Network App F5 Networks, Inc	IGP-PLTM Node	2779	System	Healthy	CUG	Active	SNMP Public V2	V2				
4	10.100.100.109	--	Network App F5 Networks, Inc	IGP-PLTM Node	3193	System	Healthy	CUG	Active	SNMP Public V2	V2				
5	10.100.100.1186	--	Network App F5 Networks, Inc	IGP-PLTM Node	2228	System	Notice	CUG	Active	SNMP Public V2	V2				
6	10.100.100.1086551	--	Network App F5 Networks, Inc	IGP-PLTM Pool Mem	1430	System	Healthy	CUG	Active	SNMP Public V2	V2				
7	10.100.100.1086222	--	Network App F5 Networks, Inc	IGP-PLTM Pool Mem	1204	System	Healthy	CUG	Active	SNMP Public V2	V2				
8	10.100.100.1087746	--	Network App F5 Networks, Inc	IGP-PLTM Pool Mem	1951	System	Healthy	CUG	Active	SNMP Public V2	V2				
9	10.100.100.1187	--	Network App F5 Networks, Inc	IGP-PLTM Node	2486	System	Healthy	CUG	Active	SNMP Public V2	V2				
10	10.100.100.1187	--	Network App F5 Networks, Inc	IGP-PLTM Node	2391	System	Healthy	CUG	Active	SNMP Public V2	V2				
11	10.100.100.1187	--	Network App F5 Networks, Inc	IGP-PLTM Node	2640	System	Healthy	CUG	Active	SNMP Public V2	V2				
12	10.100.100.11874269	--	Network App F5 Networks, Inc	IGP-PLTM Pool Mem	1652	System	Healthy	CUG	Active	SNMP Public V2	V2				
13	10.100.100.11875986	--	Network App F5 Networks, Inc	IGP-PLTM Pool Mem	1206	System	Healthy	CUG	Active	SNMP Public V2	V2				
14	10.100.100.11876098	--	Network App F5 Networks, Inc	IGP-PLTM Pool Mem	1431	System	Healthy	CUG	Active	SNMP Public V2	V2				
15	10.100.100.1188	--	Network App F5 Networks, Inc	IGP-PLTM Node	2080	System	Healthy	CUG	Active	SNMP Public V2	V2				
16	10.100.100.1188	--	Network App F5 Networks, Inc	IGP-PLTM Node	2602	System	Notice	CUG	Active	SNMP Public V2	V2				
17	10.100.100.1188	--	Network App F5 Networks, Inc	IGP-PLTM Node	3058	System	Notice	CUG	Active	SNMP Public V2	V2				
18	10.100.100.11886662	--	Network App F5 Networks, Inc	IGP-PLTM Pool Mem	2102	System	Healthy	CUG	Active	SNMP Public V2	V2				
19	10.100.100.118897340	--	Network App F5 Networks, Inc	IGP-PLTM Pool Mem	1391	System	Healthy	CUG	Active	SNMP Public V2	V2				
20	10.100.100.11897851	--	Network App F5 Networks, Inc	IGP-PLTM Pool Mem	855	System	Healthy	CUG	Active	SNMP Public V2	V2				
21	10.100.100.1237	--	Network App F5 Networks, Inc	IGP-PLTM Node	2632	System	Notice	CUG	Active	SNMP Public V2	V2				
22	10.100.100.12377659	--	Network App F5 Networks, Inc	IGP-PLTM Pool Mem	1423	System	Healthy	CUG	Active	SNMP Public V2	V2				
23	10.100.100.12125	--	Network App F5 Networks, Inc	IGP-PLTM Node	2333	System	Notice	CUG	Active	SNMP Public V2	V2				
24	10.100.100.12125	--	Network App F5 Networks, Inc	IGP-PLTM Node	2178	System	Healthy	CUG	Active	SNMP Public V2	V2				
25	10.100.100.12125	--	Network App F5 Networks, Inc	IGP-PLTM Node	2136	System	Healthy	CUG	Active	SNMP Public V2	V2				
26	10.100.100.12125	--	Network App F5 Networks, Inc	IGP-PLTM Node	2714	System	Healthy	CUG	Active	SNMP Public V2	V2				
27	10.100.100.12125	--	Network App F5 Networks, Inc	IGP-PLTM Node	2981	System	Healthy	CUG	Active	SNMP Public V2	V2				
28	10.100.100.12125	--	Network App F5 Networks, Inc	IGP-PLTM Node	1979	System	Healthy	CUG	Active	SNMP Public V2	V2				
29	10.100.100.12125	--	Network App F5 Networks, Inc	IGP-PLTM Node	2429	System	Healthy	CUG	Active	SNMP Public V2	V2				
30	10.100.100.12125	--	Network App F5 Networks, Inc	IGP-PLTM Node	2251	System	Healthy	CUG	Active	SNMP Public V2	V2				
31	10.100.100.12125	--	Network App F5 Networks, Inc	IGP-PLTM Node	2441	System	Healthy	CUG	Active	SNMP Public V2	V2				
32	10.100.100.12125	--	Network App F5 Networks, Inc	IGP-PLTM Node	2662	System	Healthy	CUG	Active	SNMP Public V2	V2				
33	10.100.100.12125	--	Network App F5 Networks, Inc	IGP-PLTM Node	2371	System	Healthy	CUG	Active	SNMP Public V2	V2				
34	10.100.100.12125	--	Network App F5 Networks, Inc	IGP-PLTM Node	2754	System	Healthy	CUG	Active	SNMP Public V2	V2				
35	10.100.100.12125	--	Network App F5 Networks, Inc	IGP-PLTM Node	2679	System	Notice	CUG	Active	SNMP Public V2	V2				
36	10.100.100.12125	--	Network App F5 Networks, Inc	IGP-PLTM Node	3053	System	Healthy	CUG	Active	SNMP Public V2	V2				
37	10.100.100.12125	--	Network App F5 Networks, Inc	IGP-PLTM Node	2115	System	Healthy	CUG	Active	SNMP Public V2	V2				
38	10.100.100.12125	--	Network App F5 Networks, Inc	IGP-PLTM Node	3008	System	Healthy	CUG	Active	SNMP Public V2	V2				
39	10.100.100.12125	--	Network App F5 Networks, Inc	IGP-PLTM Node	2366	System	Healthy	CUG	Active	SNMP Public V2	V2				
40	10.100.100.12125	--	Network App F5 Networks, Inc	IGP-PLTM Node	2790	System	Healthy	CUG	Active	SNMP Public V2	V2				
41	10.100.100.12125	--	Network App F5 Networks, Inc	IGP-PLTM Node	2642	System	Notice	CUG	Active	SNMP Public V2	V2				
42	10.100.100.12125	--	Network App F5 Networks, Inc	IGP-PLTM Node	3206	System	Healthy	CUG	Active	SNMP Public V2	V2				
43	10.100.100.12125	--	Network App F5 Networks, Inc	IGP-PLTM Node	2395	System	Notice	CUG	Active	SNMP Public V2	V2				

3. In the **Device Properties** page for the device, select the **[Actions]** menu. Select **Clear Device Cache**.

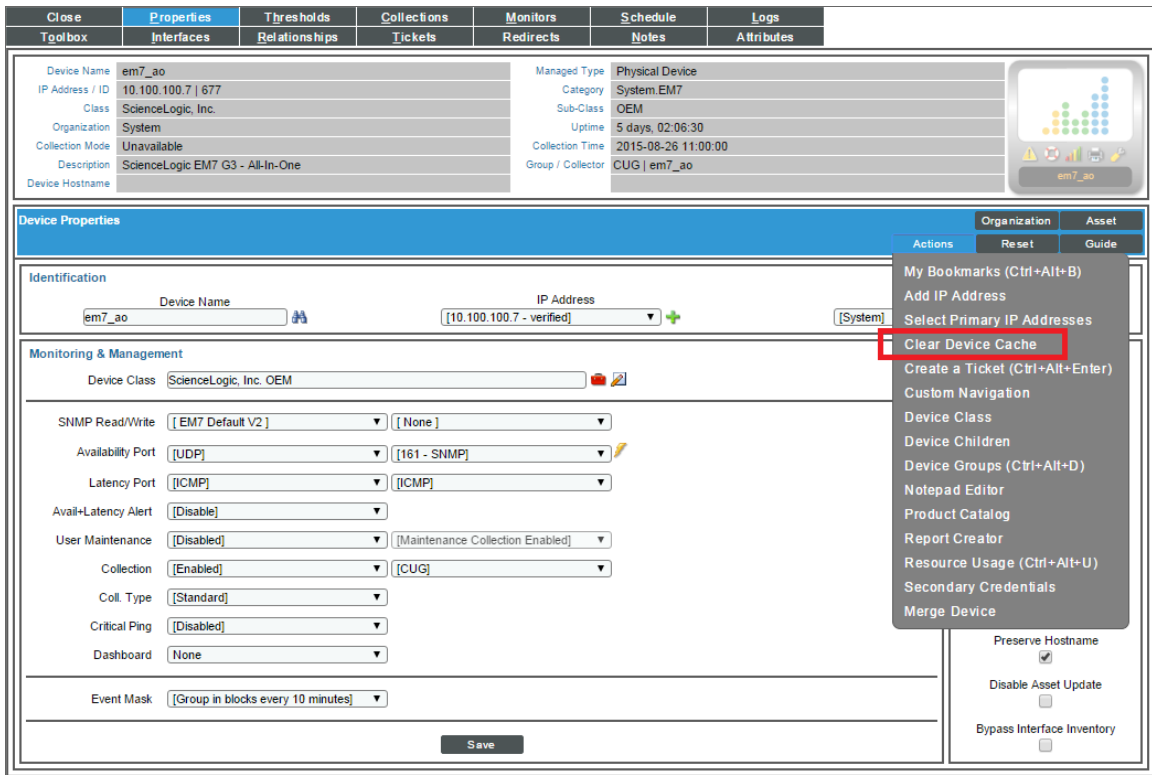

4. Data about the device will be cleared from the cache.

## Aligning a Secondary Credential

During initial discovery of a device, SL1 uses a specified SNMP credential. If you specified that SL1 should discover non-SNMP devices, SL1 will use ICMP and nmap to gather information about a device. After SL1 finds devices, discovery can use a second list of specified credentials to access database data, SOAP data, XML data or data that is monitored with a Snippet Dynamic Application.

After initial discovery, you can add additional credentials to a device. For example, if more than one SNMP agent is running on the device, each agent can now be associated with its own credential. If SL1 will be monitoring multiple applications on the device, each application can now be associated with its own credential. During the next discovery session, SL1 will use the appropriate credential for each agent or application on the device.

**NOTE:** When performing a nightly discovery on a device or when performing a manual discovery on a device, SL1 uses the credentials in this order: 1) Each credential manually aligned with each Dynamic Application in the **Dynamic Application Collections** page, in the **Device Administration** panel; 2) Secondary credentials defined in the **Device Properties** page, in the **Device Administration** panel; 3) The SNMP Read/Write string defined in the **Device Properties** page, in the **Device Administration** panel; 4) The credential used in the initial discovery session for the device.

To associate one or more additional credentials with a device:

1. Go to the **Device Manager** page (Devices > Device Manager).
2. In the **Device Manager** page, find the device for which you want to define additional credentials. Select the wrench icon () for the device.

Device Manager   Devices Found (1293)										Actions		Report	Reset	Guide	
Device Name	Device Hostname	IP Address	Device Category	Device Class / Sub-class	DD	Organization	Current State	Collection Group	Collection State	SNMP Credential	SNMP Version				
1	10.100.100.40	10.100.100.40	Pingable	Ping   ICMP	274	System	Healthy	CUG	User-Disabled	--	--				
2	10.100.100.45	10.100.100.45	Pingable	FreeSO   CIMP	294	John	Healthy	CUG	User-Disabled	--	--				
3	10.7.12.186	--	Network App F5 Networks, Inc.	IGP-PLTM Node	2778	System	Healthy	CUG	Active	SNMP Public V2	V2				
4	10.7.12.186	--	Network App F5 Networks, Inc.	IGP-PLTM Node	3193	System	Healthy	CUG	Active	SNMP Public V2	V2				
5	10.7.12.186	--	Network App F5 Networks, Inc.	IGP-PLTM Node	2228	System	Notice	CUG	Active	SNMP Public V2	V2				
6	10.7.12.186	--	Network App F5 Networks, Inc.	IGP-PLTM Pool Mem	1430	System	Healthy	CUG	Active	SNMP Public V2	V2				
7	10.7.12.186	--	Network App F5 Networks, Inc.	IGP-PLTM Pool Mem	1204	System	Healthy	CUG	Active	SNMP Public V2	V2				
8	10.7.12.186	--	Network App F5 Networks, Inc.	IGP-PLTM Pool Mem	1951	System	Healthy	CUG	Active	SNMP Public V2	V2				
9	10.7.12.187	--	Network App F5 Networks, Inc.	IGP-PLTM Node	2486	System	Healthy	CUG	Active	SNMP Public V2	V2				
10	10.7.12.187	--	Network App F5 Networks, Inc.	IGP-PLTM Node	2391	System	Healthy	CUG	Active	SNMP Public V2	V2				
11	10.7.12.187	--	Network App F5 Networks, Inc.	IGP-PLTM Node	2640	System	Healthy	CUG	Active	SNMP Public V2	V2				
12	10.7.12.187	--	Network App F5 Networks, Inc.	IGP-PLTM Pool Mem	1952	System	Healthy	CUG	Active	SNMP Public V2	V2				
13	10.7.12.187	--	Network App F5 Networks, Inc.	IGP-PLTM Pool Mem	1206	System	Healthy	CUG	Active	SNMP Public V2	V2				
14	10.7.12.187	--	Network App F5 Networks, Inc.	IGP-PLTM Pool Mem	1431	System	Healthy	CUG	Active	SNMP Public V2	V2				
15	10.7.12.188	--	Network App F5 Networks, Inc.	IGP-PLTM Node	2688	System	Healthy	CUG	Active	SNMP Public V2	V2				
16	10.7.12.188	--	Network App F5 Networks, Inc.	IGP-PLTM Node	2902	System	Notice	CUG	Active	SNMP Public V2	V2				
17	10.7.12.188	--	Network App F5 Networks, Inc.	IGP-PLTM Node	3058	System	Notice	CUG	Active	SNMP Public V2	V2				
18	10.7.12.188	--	Network App F5 Networks, Inc.	IGP-PLTM Pool Mem	2102	System	Healthy	CUG	Active	SNMP Public V2	V2				
19	10.7.12.188	--	Network App F5 Networks, Inc.	IGP-PLTM Pool Mem	1391	System	Healthy	CUG	Active	SNMP Public V2	V2				
20	10.7.12.188	--	Network App F5 Networks, Inc.	IGP-PLTM Pool Mem	855	System	Healthy	CUG	Active	SNMP Public V2	V2				
21	10.7.12.237	--	Network App F5 Networks, Inc.	IGP-PLTM Node	2632	System	Notice	CUG	Active	SNMP Public V2	V2				
22	10.7.12.237	--	Network App F5 Networks, Inc.	IGP-PLTM Pool Mem	1423	System	Healthy	CUG	Active	SNMP Public V2	V2				
23	10.7.12.125	--	Network App F5 Networks, Inc.	IGP-PLTM Node	2333	System	Notice	CUG	Active	SNMP Public V2	V2				
24	10.7.12.125	--	Network App F5 Networks, Inc.	IGP-PLTM Node	2178	System	Healthy	CUG	Active	SNMP Public V2	V2				
25	10.7.12.125	--	Network App F5 Networks, Inc.	IGP-PLTM Node	2196	System	Healthy	CUG	Active	SNMP Public V2	V2				
26	10.7.12.125	--	Network App F5 Networks, Inc.	IGP-PLTM Node	2714	System	Healthy	CUG	Active	SNMP Public V2	V2				
27	10.7.12.125	--	Network App F5 Networks, Inc.	IGP-PLTM Node	2881	System	Healthy	CUG	Active	SNMP Public V2	V2				
28	10.7.12.125	--	Network App F5 Networks, Inc.	IGP-PLTM Node	1979	System	Healthy	CUG	Active	SNMP Public V2	V2				
29	10.7.12.125	--	Network App F5 Networks, Inc.	IGP-PLTM Node	2429	System	Healthy	CUG	Active	SNMP Public V2	V2				
30	10.7.12.125	--	Network App F5 Networks, Inc.	IGP-PLTM Node	2261	System	Healthy	CUG	Active	SNMP Public V2	V2				
31	10.7.12.125	--	Network App F5 Networks, Inc.	IGP-PLTM Node	2441	System	Healthy	CUG	Active	SNMP Public V2	V2				
32	10.7.12.125	--	Network App F5 Networks, Inc.	IGP-PLTM Node	2662	System	Healthy	CUG	Active	SNMP Public V2	V2				
33	10.7.12.125	--	Network App F5 Networks, Inc.	IGP-PLTM Node	2371	System	Healthy	CUG	Active	SNMP Public V2	V2				
34	10.7.12.125	--	Network App F5 Networks, Inc.	IGP-PLTM Node	2744	System	Healthy	CUG	Active	SNMP Public V2	V2				
35	10.7.12.125	--	Network App F5 Networks, Inc.	IGP-PLTM Node	2679	System	Notice	CUG	Active	SNMP Public V2	V2				
36	10.7.12.125	--	Network App F5 Networks, Inc.	IGP-PLTM Node	3053	System	Healthy	CUG	Active	SNMP Public V2	V2				
37	10.7.12.125	--	Network App F5 Networks, Inc.	IGP-PLTM Node	2115	System	Healthy	CUG	Active	SNMP Public V2	V2				
38	10.7.12.125	--	Network App F5 Networks, Inc.	IGP-PLTM Node	3008	System	Healthy	CUG	Active	SNMP Public V2	V2				
39	10.7.12.125	--	Network App F5 Networks, Inc.	IGP-PLTM Node	2369	System	Healthy	CUG	Active	SNMP Public V2	V2				
40	10.7.12.125	--	Network App F5 Networks, Inc.	IGP-PLTM Node	2790	System	Healthy	CUG	Active	SNMP Public V2	V2				
41	10.7.12.125	--	Network App F5 Networks, Inc.	IGP-PLTM Node	2642	System	Notice	CUG	Active	SNMP Public V2	V2				
42	10.7.12.125	--	Network App F5 Networks, Inc.	IGP-PLTM Node	3206	System	Healthy	CUG	Active	SNMP Public V2	V2				
43	10.7.12.125	--	Network App F5 Networks, Inc.	IGP-PLTM Node	2395	System	Notice	CUG	Active	SNMP Public V2	V2				

- In the **Device Properties** page, select the **[Actions]** menu and choose **Secondary Credentials**.

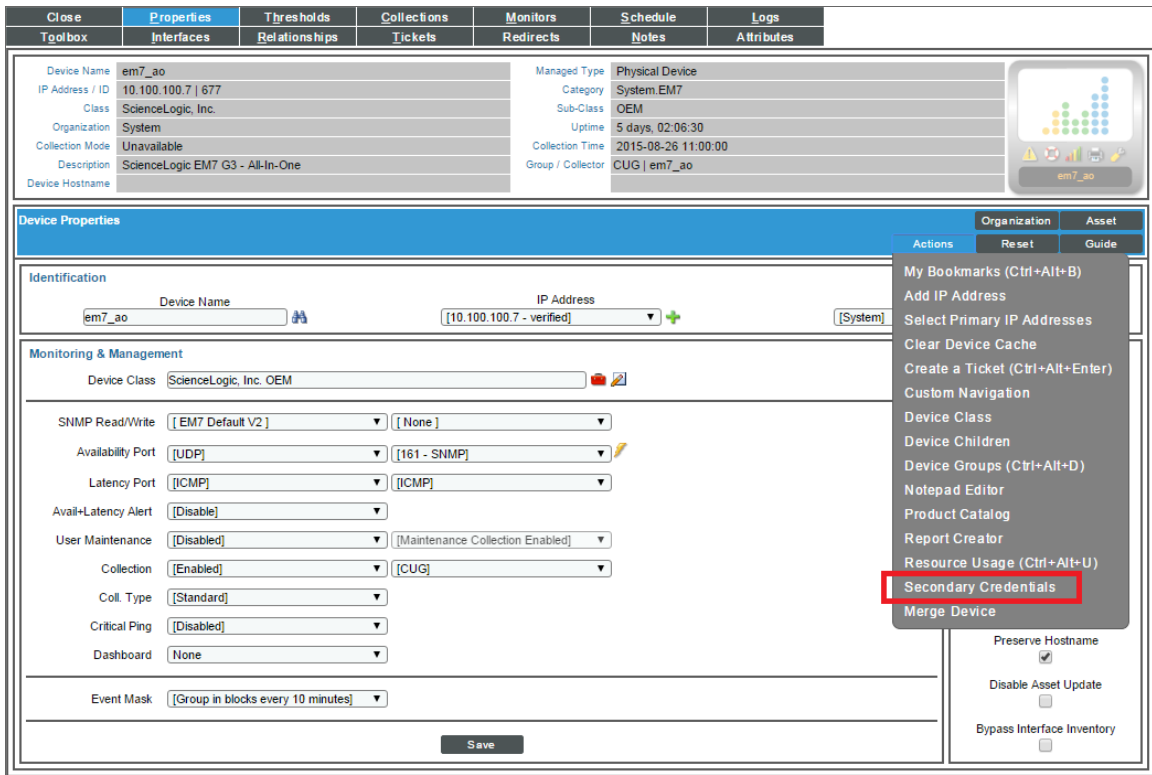

- The **Secondary Credentials** modal page appears. The **Secondary Credentials** modal page displays a list of all credentials defined in SL1.

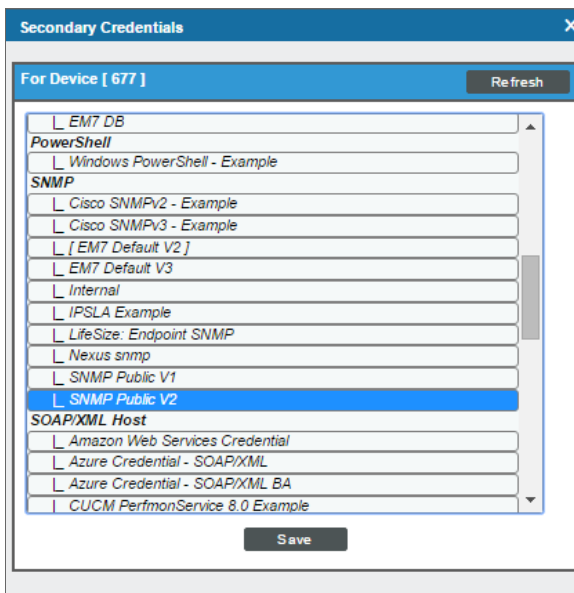

**NOTE:** When defining primary and secondary credentials for a device, you will see only the credentials aligned to organizations you are a member of. If a primary or secondary credential has already been defined on the device, and is aligned to an organization you are not a member of, the credential will be restricted. To learn more about credentials and organizations, see the manual *Discovery and Credentials*.

- **To add a credential**, highlight an entry in the list of credentials.
- **To select multiple credentials**, hold down the <CTRL> key and select the entries by left-clicking.
- **To remove all secondary credentials from a device**, select the **Remove All/None** option.

5. Select the **[Save]** button.

---

## Adding the Device to a Device Group

A **device group** is a group of multiple devices. Device groups allow you to configure and edit multiple devices simultaneously. You can view a list of existing device groups, edit a device group, or define a new device group in the **Device Group Editor** page (Devices > Device Groups).

**Device configuration templates** allow you to save a device configuration and apply it to one or more devices, and re-use the same configuration over and over again. A device template contains pre-defined settings for all the fields in the **Device Properties** page (except device name and device IP) and all the fields in the **Device Thresholds** page. Device templates can also apply policies for interface monitoring, port monitoring, web-content monitoring, service monitoring, and process monitoring and align devices with Dynamic Applications. You can view and define device templates in the **Configuration Templates** (Devices > Templates) page.

You can apply device configuration templates to a device group and automate the initial configuration of multiple devices. You can also use device groups and device configuration templates to modify the configuration of multiple devices.

For details on device groups and device templates, see the manual *Device Groups and Device Templates*.

To add a device to an existing device group:

1. Go to the **Device Manager** page (Devices > Device Manager).
2. In the **Device Manager** page, find the device that you want to add to a device group. Select the wrench icon () for the device.



3. In the **Device Properties** page, select the **[Actions]** menu and choose **Device Groups**.

The screenshot displays the 'Device Properties' page for a device named 'em7\_ao'. The page is divided into several sections: Identification, Monitoring & Management, and a right-hand sidebar. The 'Actions' menu is open, showing various options, with 'Device Groups (Ctrl+Alt+D)' highlighted in a red box. The 'Device Properties' page includes fields for Device Name, IP Address, Device Class, and various monitoring settings like SNMP Read/Write, Availability Port, Latency Port, and User Maintenance. The right-hand sidebar contains options like 'Organization', 'Asset', 'Reset', and 'Guide'.

Close	Properties	Thresholds	Collections	Monitors	Schedule	Logs
Toolbox	Interfaces	Relationships	Tickets	Redirects	Notes	Attributes

Device Name: em7\_ao  
IP Address / ID: 10.100.100.7 | 677  
Class: ScienceLogic, Inc.  
Organization: System  
Collection Mode: Unavailable  
Description: ScienceLogic EM7 G3 - All-In-One  
Device Hostname: em7\_ao

Managed Type: Physical Device  
Category: System EM7  
Sub-Class: OEM  
Uptime: 5 days, 02:06:30  
Collection Time: 2015-08-26 11:00:00  
Group / Collector: CUG | em7\_ao

**Device Properties**

Identification

Device Name: em7\_ao | IP Address: [10.100.100.7 - verified] | [System]

Monitoring & Management

Device Class: ScienceLogic, Inc. OEM

SNMP Read/Write: [EM7 Default V2] | [None]

Availability Port: [UDP] | [161 - SNMP]

Latency Port: [ICMP] | [ICMP]

Avail-Latency Alert: [Disable]

User Maintenance: [Disable] | [Maintenance Collection Enabled]

Collection: [Enabled] | [CUG]

Coll. Type: [Standard]

Critical Ping: [Disable]

Dashboard: None

Event Mask: [Group in blocks every 10 minutes]

Save

Organization: Asset

Actions: Reset, Guide

- My Bookmarks (Ctrl+Alt+B)
- Add IP Address
- Select Primary IP Addresses
- Clear Device Cache
- Create a Ticket (Ctrl+Alt+Enter)
- Custom Navigation
- Device Class
- Device Children
- Device Groups (Ctrl+Alt+D)**
- Notepad Editor
- Product Catalog
- Report Creator
- Resource Usage (Ctrl+Alt+U)
- Secondary Credentials
- Merge Device

Preserve Hostname:

Disable Asset Update:

Bypass Interface Inventory:

- The **Device Groups** modal page appears. The **Device Groups** modal page allows you to assign a device to a device group or remove a device from a device group.

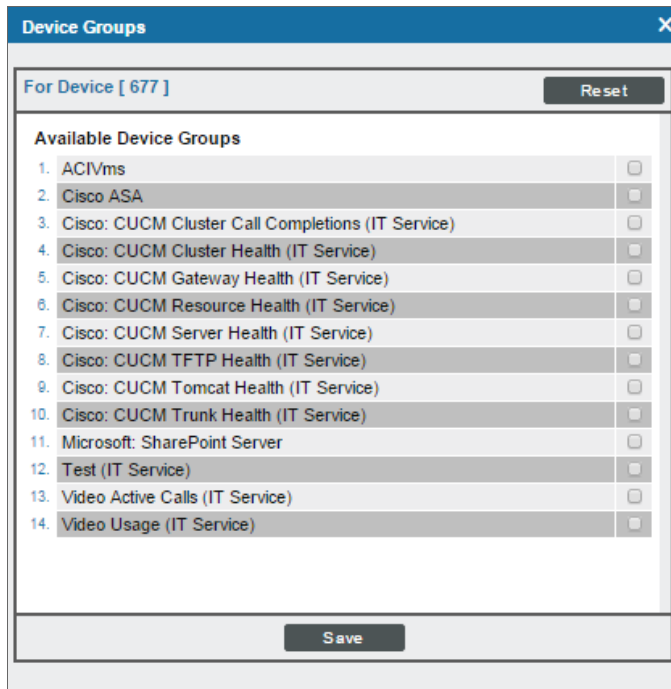

- To add the device to a device group**, in the **Available Device Groups** pane, select one or more device groups. After selecting the **[Save]** button, the device group will appear in the **Member Device Groups** pane.
  - To remove the device from a device group**, in the **Member Device Groups** pane, select one or more device groups. After selecting the **[Save]** button, the device group will appear in the **Available Device Groups** pane.
- Select the **[Save]** button.
  - To remove the device from a device group, in the **Member Device Groups** pane, select one or more device groups.
  - Select the **[Save]** button.

---

## Creating a Ticket About the Device

A ticket is a request for work. Tickets allow you to monitor work tasks associated with your network. You can create a ticket about a device. The ticket can describe a problem with the device or a maintenance task for the device.

For details on tickets and ticketing, see the manual *Ticketing*.

To create a ticket for a device:

1. Go to the **Device Manager** page (Devices > Device Manager).
2. In the **Device Manager** page, find the device about which you want to create a ticket. Click the wrench icon () for the device.
3. In the **Device Properties** page, click the **[Actions]** menu and select **Create a Ticket**.

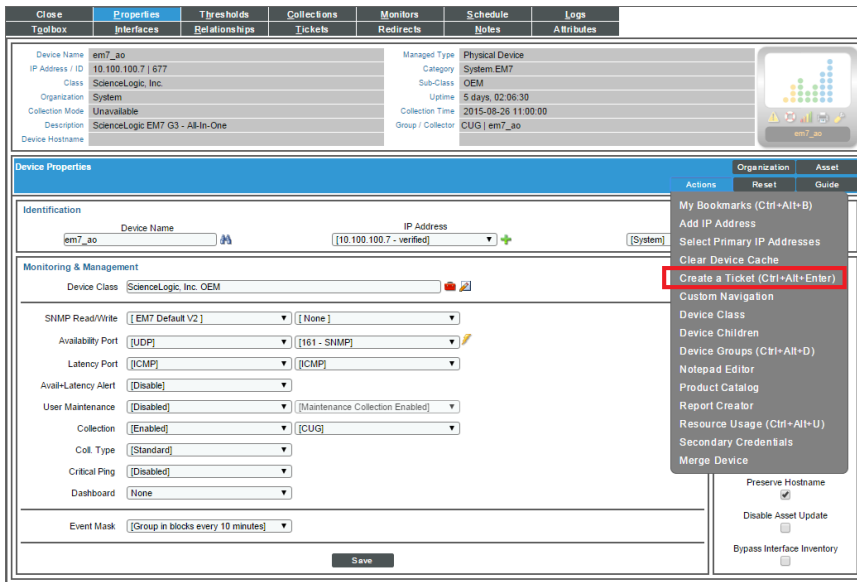

The screenshot displays the 'Device Properties' page for a device named 'em7\_a0'. The page is divided into several sections: 'Identification', 'Monitoring & Management', and 'Actions'. The 'Identification' section includes fields for Device Name, IP Address, and Organization. The 'Monitoring & Management' section contains various configuration options such as Device Class, SNMP Read/Write, Availability Port, Latency Port, Avail+Latency Alert, User Maintenance, Collection, Col. Type, Critical Ping, Dashboard, and Event Mask. The 'Actions' menu is open on the right side, showing options like 'My Bookmarks', 'Add IP Address', 'Select Primary IP Addresses', 'Clear Device Cache', 'Create a Ticket (Ctrl+Alt+Enter)', 'Custom Navigation', 'Device Class', 'Device Children', 'Device Groups', 'Notepad Editor', 'Product Catalog', 'Report Creator', 'Resource Usage', 'Secondary Credentials', and 'Merge Device'. The 'Create a Ticket (Ctrl+Alt+Enter)' option is highlighted in red.

4. The **Ticket Editor** page appears. In this page, you can define the basic parameters for a ticket. Notice that the **Description** field and **Element** field are automatically populated with the device name.

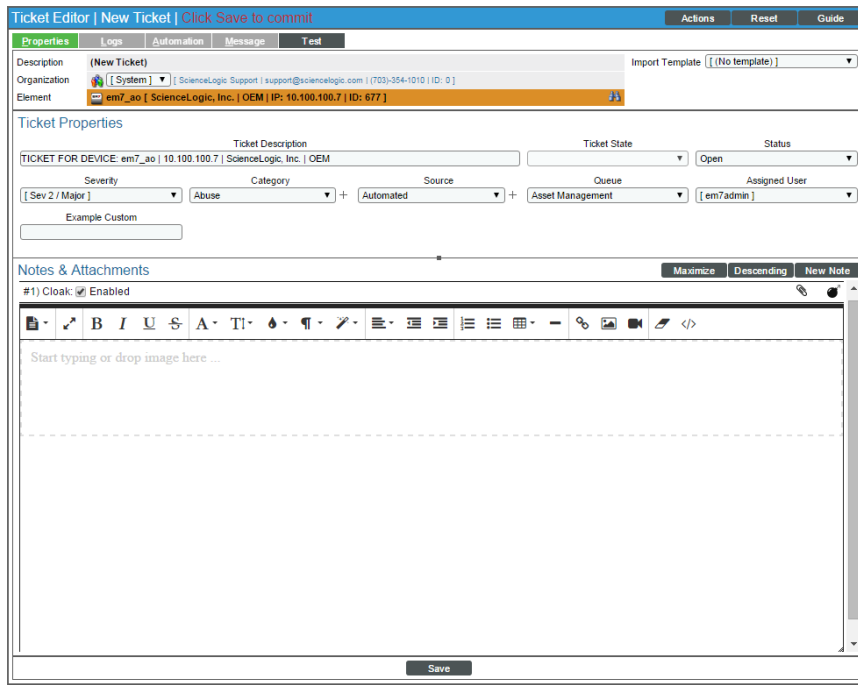

5. Click the **[Save]** button to save the ticket.

---

## Adding a Note to a Device

You can add notes about a device to the device administration panel. The note will appear in the **Notes & Attachments** page (the **[Notes]** tab in the **Device Administration** panel). Each note you add to the device can include formatted text, links, images, videos, and attachments.

To add a note to a device:

1. Go to the **Device Manager** page (Devices > Device Manager).
2. In the **Device Manager** page, find the device that you want to add a note to. Click the wrench icon (🔧) for the device.

3. In the **Device Properties** page, click the **[Actions]** menu and select **Notepad Editor**.

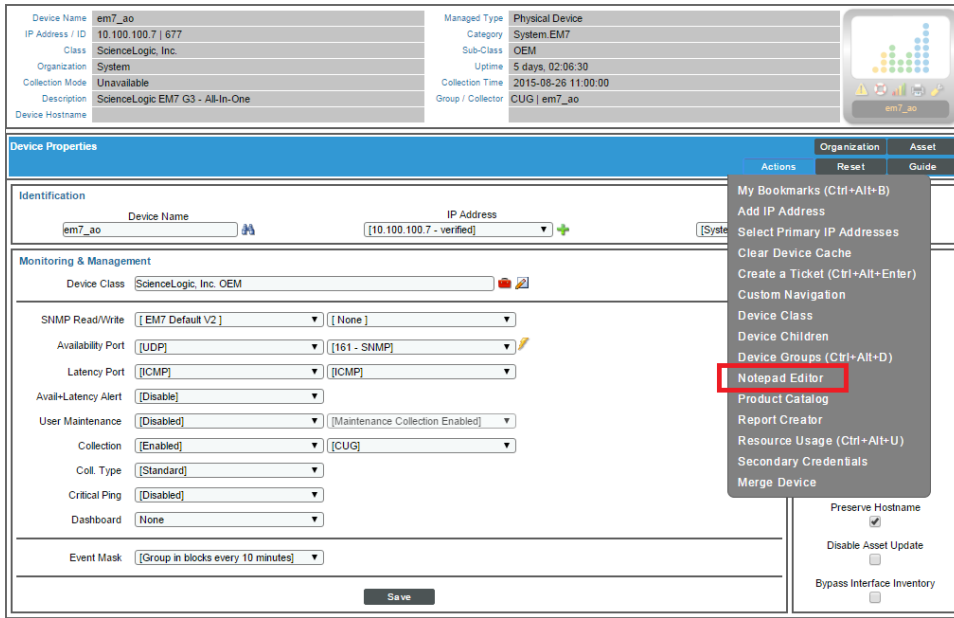

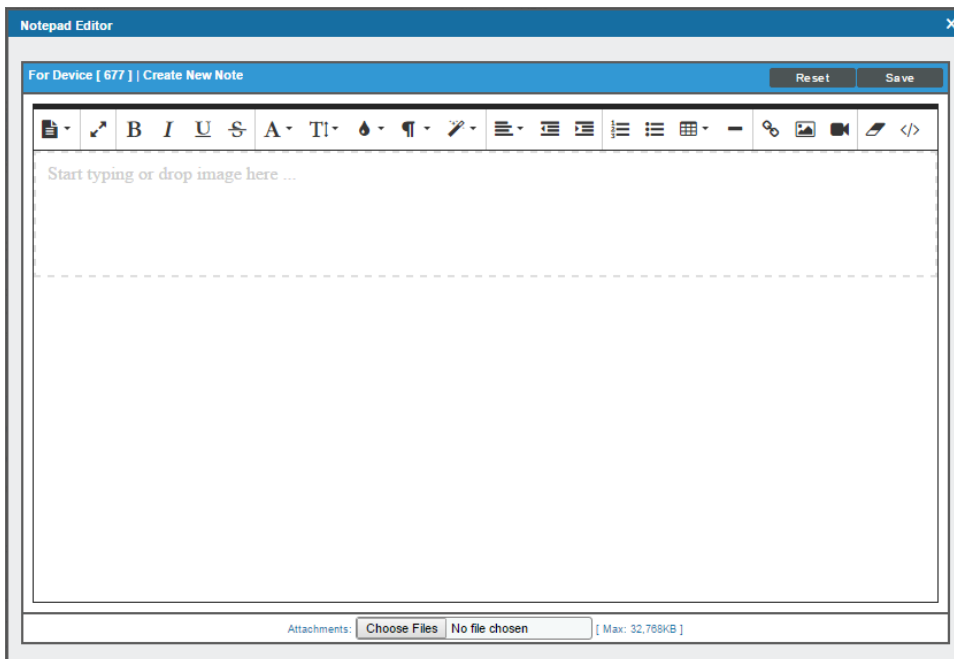

4. The **Notepad Editor** modal page appears. In this page, you can enter and format text, include images and links in the message, and include an attachment. Click the **[Save]** button to save the note.

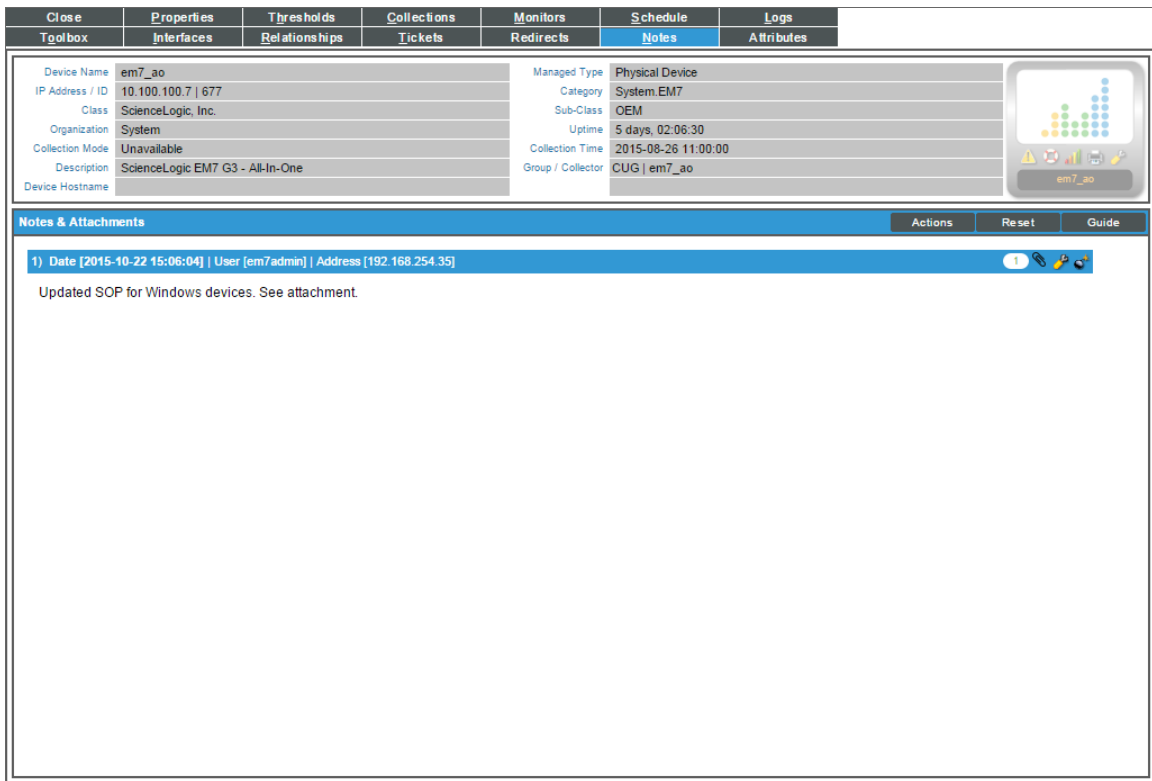

5. The **Notepad Editor** modal page allows you to enter notes or comments about the device.
  - You can format the text and include links, images, and videos in the note.
  - You can also include a document template (System > Customize > Document Templates) in the field.
6. The note will appear in the **[Notes]** tab, in the **Notes & Attachments** page.



7. The **Notes & Attachments** page displays all the notes about the device that were created with the **Notepad Editor** modal page. In the **Notes & Attachments** page, each entry includes the username, date and time, and text of the comment. You can perform the following on each note entry:

- **To view a note's attachment**, click the paperclip icon (  ).
- **To edit the content of a note**, click the wrench icon (  ). The **Notepad Editor** modal page appears. You can update the note; format the text; insert content from a saved template; and add an attachment, image, or video to the note. Click the **[Save]** button to save your changes.
- **To delete a note**, click its bomb icon (  ).

**NOTE:** For information about adding a note to a device on the **[Notes]** tab of the **Device Investigator**, see the section on [The Notes Tab](#).

# Aligning Custom Attributes with a Device

You can align custom attributes with a device, assign values to those custom attributes (for the selected device only), and create new extended custom attributes for a device on the **Attributes** page (the **Attributes** tab in the **Device Administration** panel).

**NOTE:** For more information on custom attributes, see the chapter on [Custom Attributes](#).

To align custom attributes with a device:

1. Go to the **Device Manager** page (Devices > Device Manager).
2. Find the device that you want to align with a custom attribute. Click its wrench icon (  ).
3. Click the **[Attributes]** tab.
4. In the **Attributes** page, go to the **Please Select** field in the bottom-most row.

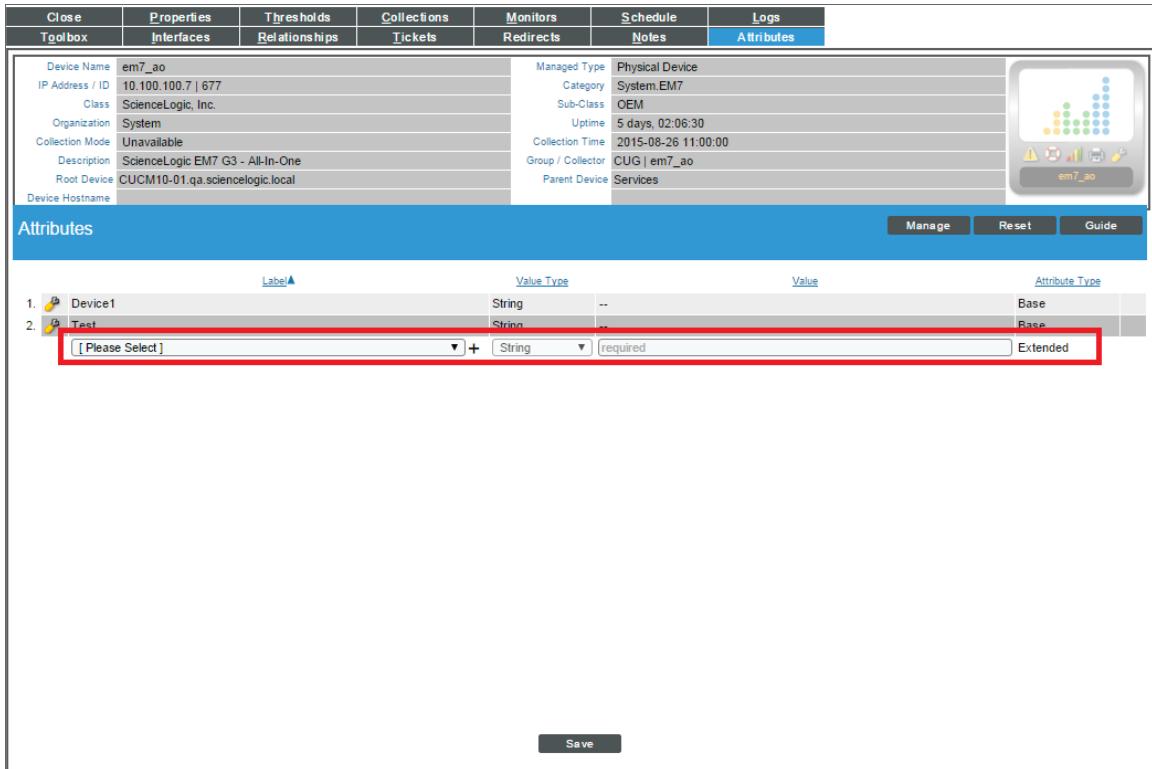

5. Select the custom attribute that you want to align with the device.
6. Supply a value in the **Value** field.

**NOTE:** To align an extended custom attribute with a device, you must supply a value. You cannot align an extended custom attribute to a device and leave the value as "null."

**NOTE:** Base custom attributes for devices are automatically aligned with each device in your SL1 System. If the base custom attribute does not include a value for this device, the **Value** column will display "--" (dash dash). To assign a value to an "empty" base custom attribute: Find the base custom attribute that you want to edit, select its wrench icon () , and supply a value in the **Value** field.

7. Click the **[Save]** button.

## Creating a New Extended Custom Attribute

You can create a new extended custom attribute from the **Attributes** page. The custom attribute is then aligned with the current device and available to be used by any device in your SL1 System. To create a new extended custom attribute:

1. Go to the **Device Manager** page (Devices > Device Manager).
2. Find the device for which you want to create a new custom attribute. Click its wrench icon () .
3. Click the **[Attributes]** tab.



- In the **Attributes** page, click the plus icon ( **+** ) in the bottom-most row, then supply a value in the following fields:

Label	Value Type	Value	Attribute Type
Device1	String	--	Base
Test	String		Base
required	String	required	Extended

- Label.** User-defined name for the custom attribute. This value appears in the user interface. If the value in this field does not comply with XML rules for names, SL 1 will convert the value to a name that complies with XML rules and store the converted value as the **Internal Field Name** for the custom attribute.

**NOTE:** Names for custom attributes must conform to XML naming standards. The attribute name can contain any combination of alphanumeric characters, a period, a dash, a combining character or an extending character. If a value in the **Internal Field Name** column does not conform to XML standards, SL 1 will replace non-valid characters with an underscore plus the hexadecimal value of the illegal character plus an underscore. So "serial number" would be replaced with "serial\_X20\_number".

- Value Type.** Specifies the type of value that will be saved in the custom attribute. Choices are:
  - String.* Non-numeric value
  - Integer.* Numeric value
- Value.** Value that will be assigned to the custom attribute for this device.



5. Click the **[Save]** button.

## Deleting an Extended Custom Attribute from a Device

You can delete an extended custom attribute from a device. When you delete the custom attribute, you remove the value from the custom attribute and unalign the custom attribute with the device.

**NOTE:** You cannot delete a base custom attribute from the **Attributes** page. To delete a base custom attribute, you must go to the **Custom Attribute Manager** page (System > Manage > Custom Attributes).

To delete an extended custom attribute from a device:

1. Go to the **Device Manager** page (Devices > Device Manager).
2. Find the device for which you want to delete a custom attribute. Click its wrench icon (.
3. Click the **[Attributes]** tab.
4. In the **Attributes** page, find the extended custom attribute you want to delete. Click its bomb icon (.

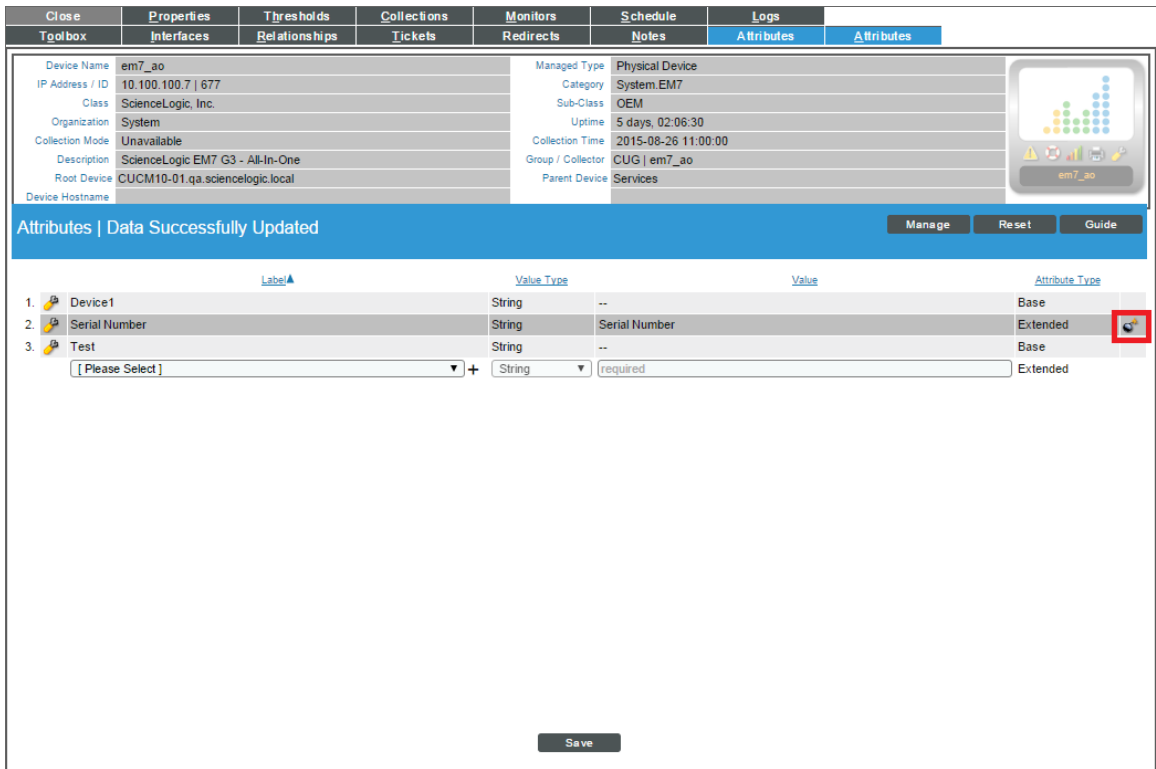

5. A message appears asking you to confirm that you want to delete the value and unalign the custom attribute from the device.
6. Click the **[OK]** button.

# Associating a Product SKU with the Device

A product SKU describes a billable product or service and can be used later to create a billing policy. For details on creating and editing product SKUs, see the **Product Catalog** page (Registry > Business Services > Product Catalog). For information on billing policies, see the **Bandwidth Billing Policies** page (Registry > Business Services > Bandwidth Billing).

You can associate a product SKU with a device and then use a bandwidth billing policy to generate a bill that includes the device.

For details on product SKUs and bandwidth billing policies, see the manual **Business Services**.

To associate a product SKU with a device:

1. Go to the **Device Manager** page (Devices > Device Manager).
2. In the **Device Manager** page, find the device that you want to add a note to. Select the wrench icon (  ) for the device.
3. In the **Device Properties** page, select the **[Actions]** menu and choose **Product Catalog**.

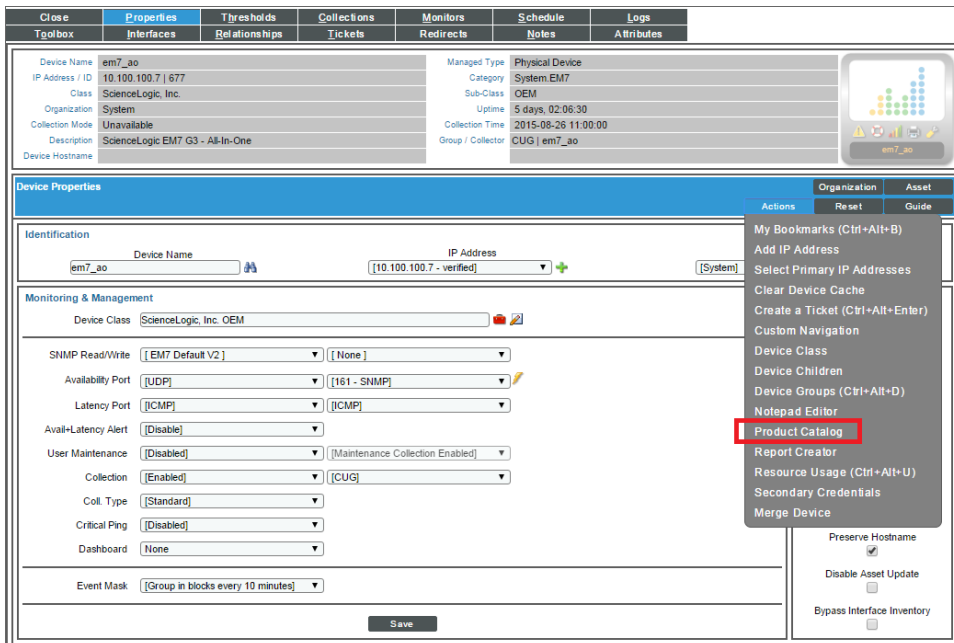

- The **Product Catalog** modal page appears. In this page, you can associate one or more product SKUs with the device.

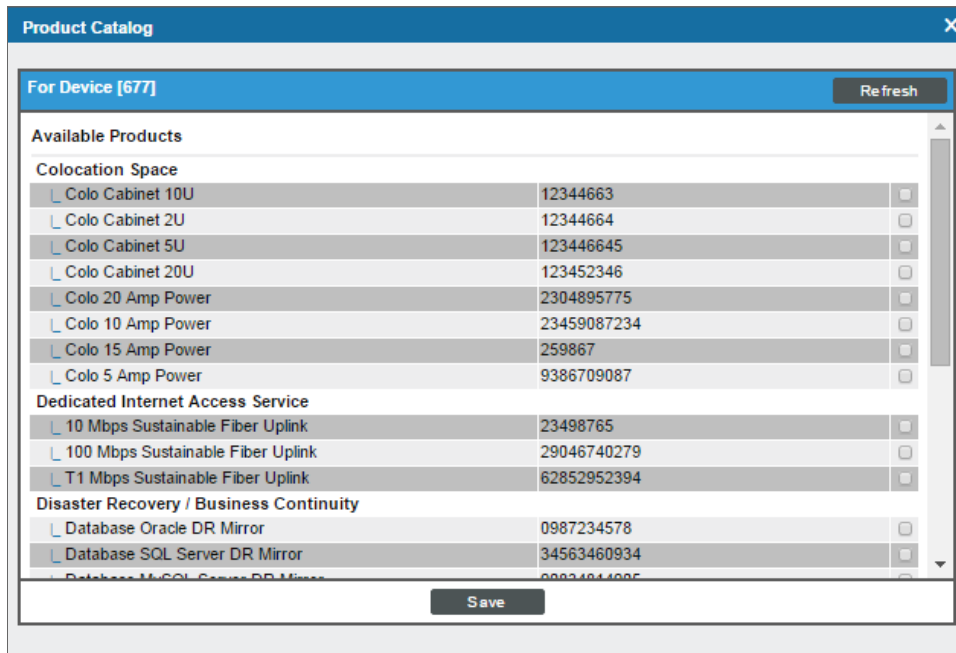

- To associate a product SKU with the device**, in the **Available Products** pane, select one or more product SKUs.
- To disassociate a product SKU with a device**, in the **Active Product Subscriptions** pane, select one or more product SKUs.

- Select the **[Save]** button.

---

## Merging Devices

If your SL1 system includes a physical device and a component device, you can merge those device records into a single record for easier monitoring. Merging consolidates the devices and their data—device fields, values, graphs, behaviors, and other user interface elements—providing you with a single set of data for the device. Additionally, merged devices consume only a single device license.

Merging does not remove, replace, or add any data; merging simply groups data together. When you merge a physical device and a component device, the device record for the component device no longer displays in the user interface, while the device record for the physical device displays in user interface pages that previously displayed the component device. For example, the physical device is displayed instead of the component device in the **Device Components** page and the **Component Map** page. All existing and future data for both devices will be associated with the record for the physical device.

Merged devices can be unmerged back into individual device records, if needed.

**NOTE:** You can merge only two individual devices together into a single merged device. To do so, you must have user permissions that allow merging and unmerging on both devices.

**NOTE:** When you merge devices, active events associated with the component device will be set to "cleared." The cleared events will not be associated with the physical device. If the devices are unmerged, the cleared events cannot be moved back to the component device.

**CAUTION:** Merging devices also merges the log data from each device. The log data cannot later be unmerged.

SL1 enables you to either merge one pair of devices at a time, as described in the [Merging Individual Devices](#) section, or multiple pairs of devices at one time, as described in the [Performing a Bulk Device Merge](#) section. For information about unmerging devices, see the [Unmerging Individual Devices](#) section or the [Performing a Bulk Device Unmerge](#) section.

## Merging Individual Devices

If you have a small number of physical and component devices that you want to merge, you can merge each device pair individually.

**NOTE:** If you have a large number of devices you want to merge, it might be more efficient to use the Bulk Merge feature, which is described in the [Performing a Bulk Device Merge](#) section.

**NOTE:** For clarity, the following instructions describe how to merge a physical device from the **Device Manager** page with a selected component device, but the process is the same when merging a component device from the **Device Manager** page with a selected physical device.

To merge individual devices:

1. Go to the **Device Manager** page (Devices > Device Manager).
2. Click the wrench icon () for the physical device that you want to merge with a component device.

- On the **Device Properties** page, click the **[Actions]** menu and then select *Merge Device*.

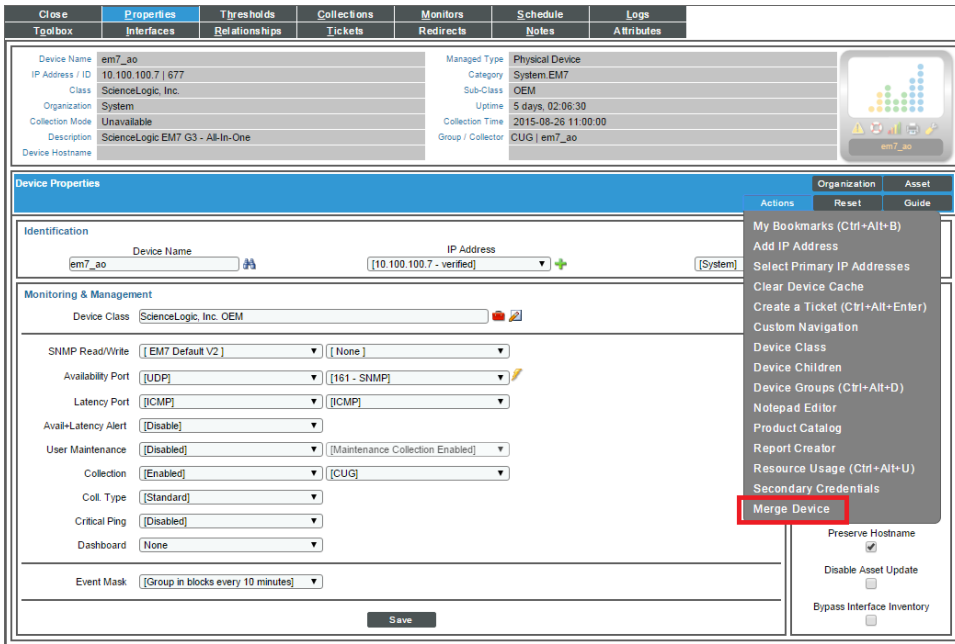

- A list of component devices that are available for merging with the physical device displays. Click the merge icon (🔗) for the component device you want to merge with the physical device. Information for the component device then displays in the **Selected Device** panel.

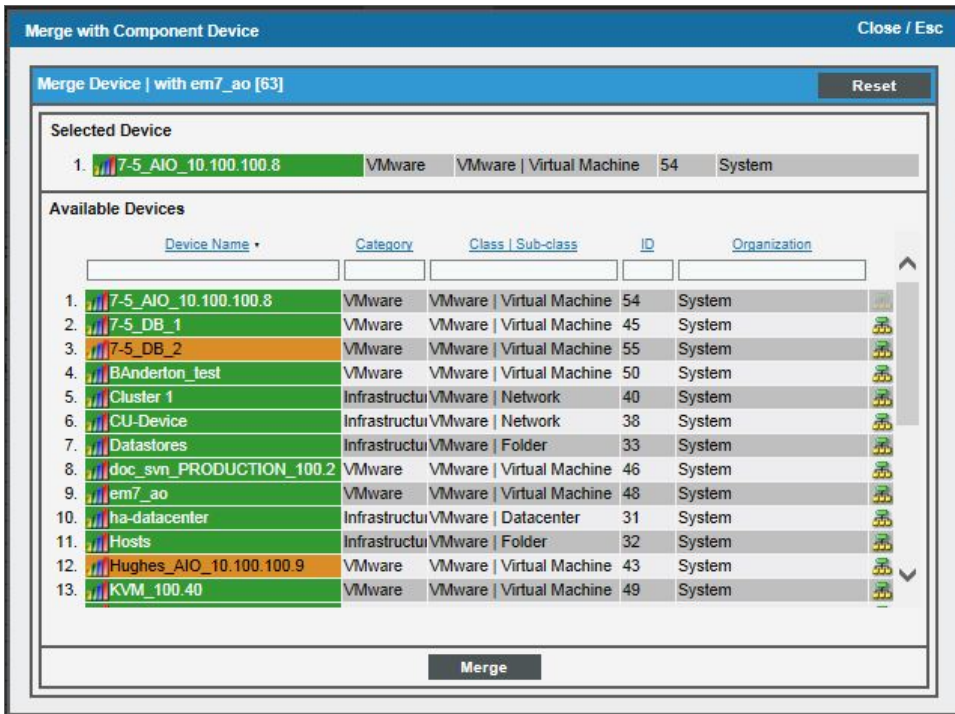

5. Click the **[Merge]** button. A pop-up message appears that asks you to confirm the merge.

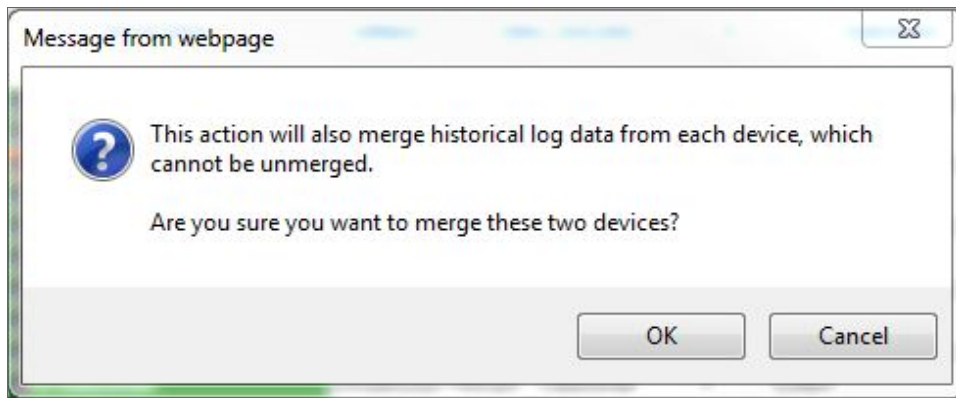

6. Click the **[OK]** button.

**NOTE:** To view an updated list of devices that includes your merged devices, click the **[Reset]** button on the **Device Manager** page.

## Unmerging Individual Devices

You can unmerge any pair of physical device and component device that are currently merged. When you unmerge devices, SL1 does not delete any devices or device data; the devices are simply separated into two separate device records.

**NOTE:** If you have a large number of devices you want to unmerge, it might be more efficient to use the Bulk Unmerge feature, which is described in the [Performing a Bulk Device Unmerge](#) section.

**CAUTION:** The log data associated with the devices cannot be unmerged. After the devices are unmerged, all log data that was generated before the devices were unmerged is associated with the physical device record.

**NOTE:** For details on unmerging a vanished device, see the chapter in this manual on *Vanishing & Purging Devices*.

To unmerge individual devices:

1. Go to the **Device Manager** page (Devices > Device Manager).
2. Select the wrench icon (  ) for the device that you want to unmerge.

- On the **Device Properties** page, select the **[Actions]** menu and then choose **Unmerge Device**.

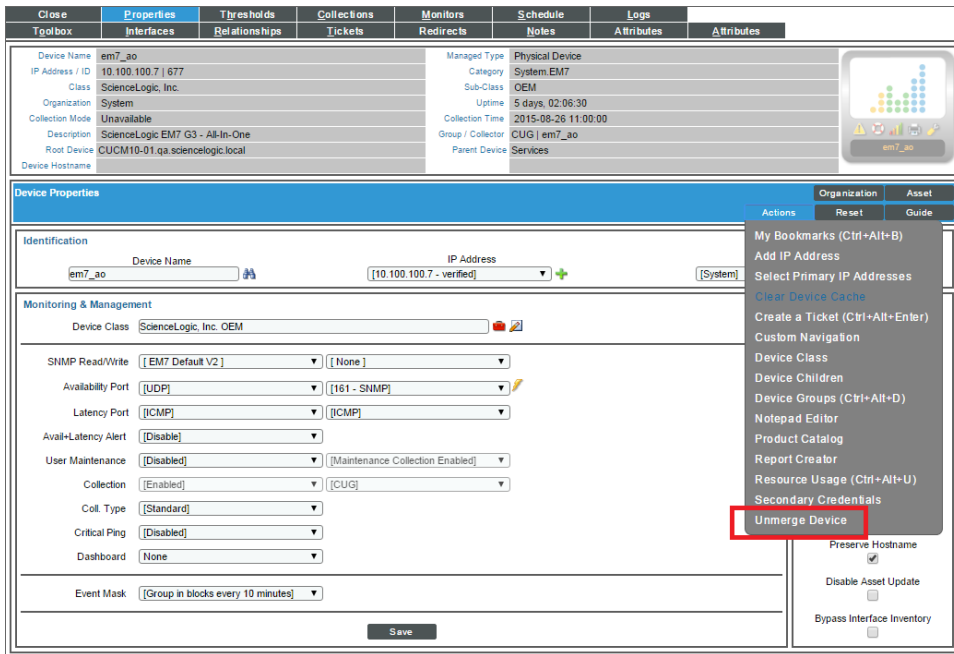

- A modal window displays that asks you to confirm the unmerging. Select the **[Unmerge]** button.



**NOTE:** To view an updated list of devices that includes your unmerged devices, select the **[Reset]** button on the **Device Manager** page.



---

## Performing Administrative Tasks for One or More Devices

The **Device Manager** page (Devices > Device Manager) contains a drop-down field in the lower right called **Select Action**. This field allows you to apply an action to multiple devices at once.

To apply an action to multiple devices:

1. In the **Device Manager** page, select the checkbox for each device you want to apply the action to. To select all checkboxes for all devices, select the red checkbox (☑) at the top of the page.
2. In the **Select Action** drop-down list, select one of the following actions:
  - **Delete Devices**. Deletes all selected devices from SL1. Tickets associated with the device are unlinked from the device, but are not deleted.
  - **Modify by Template**. Displays the **Applying Template to Device** page, where you can apply the settings in a device templates to all selected devices. You can also make one-time changes to the template, that will be applied only to the selected devices.
  - **Clear Device Logs**. Deletes data from the device's log files.
  - **Create Asset Record**. Automatically creates an asset record for the device. SL1 automatically populates as many fields as possible, using retrieved data.
  - **Schedule Maintenance**. Leads to the **Maintenance Schedule** page. In this page, you can specify a date and time to put each selected device into "maintenance mode". During maintenance mode, SL1 will not generate events about the selected devices. You can choose to enable or enable polling during maintenance mode. Even if polling is enabled, SL1 will collect information from the selected devices but will not generate events for the devices.
  - **Find Collection Label Duplicates**. Leads to the **Duplicates** page. In this page, you can view a list of devices where the Collection Labels have more than possible presentation object aligned. From this page, you can manually align a single presentation object with a Collection Label for a device.
  - **Change Collection State**. Changes the status of the device in SL1. The choices are:
    - *Active*. SL1 polls the device on a regular basis and updates the data displayed in SL1.
    - *Disabled*. SL1 does not poll the device. Data displayed in SL1 is not updated.

- **Change Maintenance Mode.** These options allow you to enable User-Initiated-Maintenance and disable both User-Initiated-Maintenance and scheduled Maintenance.

When a device is in User-Initiated-Maintenance, by default SL1 will not generate events about the device. If you want to allow events during User-Initiated-Maintenance, you can specify which events to allow in the **Behavior Settings** (System > Settings > Behavior) page. You can choose to enable or disable polling. If polling is enabled during User-Initiated-Maintenance, SL1 will collect information from the device but will generate only the events you specified in the **Behavior Settings** page. By default, SL1 will not generate any events. User-Initiated-Maintenance mode is not scheduled. That is, a user must manually enable User-Initiated-Maintenance to turn off this mode for a device. User-Initiated-Maintenance Mode overrides scheduled maintenance for a device. Choices are:

- *Enabled with Collection.* One or more devices are set to User-Initiated-Maintenance mode. During User-Initiated-Maintenance mode, SL1 will continue to poll the device.
  - *Enabled without Collection.* One or more devices are set to User-Initiated-Maintenance mode. During User-Initiated-Maintenance mode, SL1 will not poll the device.
  - *Disabled.* User-Initiated-Maintenance mode is disabled for each selected device.
- **Change Collector Group.** Changes the collector group used to collect data from the device. Choose from the list of all collector groups in SL1. When you select one of the collector groups, each selected device will be polled by the collectors in the collector group. For All-In-One Appliances, you can select only the built-in Collector Group and any virtual Collector Groups.
  - **Move To Organization.** Associates a device with an organization. The list of choices will include all organizations in SL1.
  - **Align SNMP Read Credential.** This option applies the selected credential to all selected devices. The selected devices will use the selected credential as their primary credential. Secondary credentials will remain unchanged. Choose from a list of SNMP Read credentials (defined in System > Manage > Credentials). The list will include only credentials that you are allowed to use.
  - **Add to Device Group.** This option aligns the selected devices with the selected device group. The selected devices will then appear in **Device Group Views** and will inherit the properties of the device group, including scheduling, access, and visibility.
  - **Align to Device Dashboard.** This option aligns the selected devices with the selected device dashboard. The selected device dashboard will appear as the default view in the **Device Summary** page.

3. Select the **[Go]** button.
4. The selected action is applied to each selected device.

---

## Shortcut Keys for Device Administration panel

When you edit a device (select its wrench icon (), you enter the **Device Administration** panel.

When you enter the **Device Administration** panel, you can use the following shortcut keys to navigate the tabbed pages and the entries in the **[Actions]** menu.

Page or Tab	Shortcut Keys
<b>Administer Bookmarks</b> page	Ctrl + Alt + B
<b>Dynamic Application Collections</b> page	Ctrl + Alt + C
<b>Device Groups</b> page	Ctrl + Alt + D
<b>Guides</b> page	Ctrl + Alt + G
<b>Device Thresholds</b> page	Ctrl + Alt + H
<b>Device Interfaces</b> page	Ctrl + Alt + I ("eye")
<b>Device Logs &amp; Messages</b> page	Ctrl + Alt + L
<b>Monitoring Policies</b> page	Ctrl + Alt + M
<b>Notes &amp; Attachments</b> page	Ctrl + Alt + N
<b>Device Toolbox</b> page	Ctrl + Alt + O ("oh")
<b>Device Properties</b> page	Ctrl + Alt + P
<b>Maintenance Schedule</b> page	Ctrl + Alt + S
<b>Ticket History</b> page	Ctrl + Alt + T
<b>Resource Usage</b> page	Ctrl + Alt + U
<b>Exit Device Administration</b> panel	Ctrl + Alt + X
<b>Device Properties</b> page	Ctrl + Alt + . ("period")
<b>Ticket Editor</b> page	Ctrl + Alt + <Enter>

---

# Chapter

# 6



## Device Toolbox

---

### Overview

This chapter describes the **Device Toolbox** page.

Use the following menu options to navigate the SL1 user interface:

- To view a pop-out list of menu options, click the menu icon (.
- To view a page containing all of the menu options, click the Advanced menu icon (  ).

This chapter includes the following topics:

<a href="#">What is the Device Toolbox?</a> .....	132
<a href="#">Accessing the Device Toolbox page</a> .....	132
<a href="#">Viewing the Session Logs</a> .....	135

---

### What is the Device Toolbox?

The **Device Toolbox** page allows you to access common network tools. The list of tools available depends upon the type of device and the configuration of the device.

The **Device Toolbox** page allows you to run diagnostics on a device and access devices without leaving the user interface session.

---

### Accessing the Device Toolbox page

To access the **Device Toolbox** page:

1. Go to the **Device Manager** page (Devices > Device Manager).
2. In the **Device Manager** page, find the device for which you want to access the **Device Toolbox** page. Select its wrench icon ().

Device Manager   Devices Found [176]										Actions	Report	Reset	Guide	
Device Name	IP Address	Device Category	Device Class / Subclass	CPU	Organization	Current State	Collection Group	Collection Rate	SNMP Credentials	SNMP Version				
151	10.20.0.177	Office Printers	Lexmark International   Print Server	42	System	Minor	CUG1	Active	Cisco SNMPv2 - Exa V2					
152	10.20.0.214	Unknown	Shoreline Teleworks   OEM	15	System	Healthy	CUG1	Active	Cisco SNMPv2 - Exa V2					
153	10.20.0.7	Servers	Microsoft   Windows Server 2008 R2	77	System	Minor	CUG1	Active	c8sm0s - V2					
154	10.20.0.249	Storage.NAS	Quantum Corp - Snap Division   Snap Server	156	System	Minor	CUG1	Active	Cisco SNMPv2 - Exa V2					
155	10.20.0.247	Network.Switches	Juniper Networks   M7R Router	152	System	Healthy	CUG1	Active	Cisco SNMPv2 - Exa V2					
156	10.20.0.199	Servers	Microsoft   Windows CE Version 3.0 (Multiple	27	System	Healthy	CUG1	Active	Cisco SNMPv2 - Exa V2					
157	10.20.0.92	Network.Switches	Extreme Networks   Summ48s1 Version 7.1.1	101	System	Healthy	CUG1	Active	Cisco SNMPv2 - Exa V2					
158	10.20.0.27	Servers	NET-SNMP   Solars	169	System	Major	CUG1	Active	Cisco SNMPv2 - Exa V2					
159	10.20.0.210	Telephony	DuPont   Tenor A800	18	System	Healthy	CUG1	Active	Cisco SNMPv2 - Exa V2					
160	10.20.0.1	Network.Switches	Cisco Systems   Catalyst 3750-Stack	76	System	Healthy	CUG1	Active	Cisco SNMPv2 - Exa V2					
161	10.20.0.15	Network.Switches	Brocade   Channel-AL Switch	104	System	Healthy	CUG1	Active	Cisco SNMPv2 - Exa V2					
162	10.20.0.217	Unknown	Tandberg ASA   OEM	12	System	Healthy	CUG1	Active	Cisco SNMPv2 - Exa V2					
163	10.20.0.157	Network.Firewall	Cisco Systems   ASA 5520	146	System	Minor	CUG1	Active	Cisco SNMPv2 - Exa V2					
164	10.20.0.86	Unknown	Tec Corporation   OEM	124	System	Minor	CUG1	Active	Cisco SNMPv2 - Exa V2					
165	10.20.0.229	Unknown	Xerox   OEM	81	System	Minor	CUG1	Active	Cisco SNMPv2 - Exa V2					
166	10.20.0.71	Network.Switches	Cisco Systems   TS SEC	68	System	Healthy	CUG1	Active	Cisco SNMPv2 - Exa V2					
167	10.20.0.72	Network.Switches	Cisco Systems   TS SEC	67	System	Healthy	CUG1	Active	Cisco SNMPv2 - Exa V2					
168	10.20.0.166	Unknown	HP   OEM	166	System	Minor	CUG1	Active	Cisco SNMPv2 - Exa V2					
169	10.20.0.77	Environmental	URS APC   SmartUPS 2200	66	System	Critical	CUG1	Active	Cisco SNMPv2 - Exa V2					
170	10.20.0.166	Unknown	General Instrument   OEM	55	System	Healthy	CUG1	Active	Cisco SNMPv2 - Exa V2					
171	10.20.0.227	Telephony	Vina Technologies   Multiplexor	136	System	Healthy	CUG1	Active	Cisco SNMPv2 - Exa V2					
172	10.20.0.64	Servers	Empire Technologies   Default Enterprise Agent	87	System	Critical	CUG1	Active	Cisco SNMPv2 - Exa V2					
173	10.20.0.92	Network.Router	Cisco Systems   1750	83	System	Minor	CUG1	Active	Cisco SNMPv2 - Exa V2					
174	10.20.0.228	Unknown	Generic   SNMP	78	System	Healthy	CUG1	Active	Cisco SNMPv2 - Exa V2					
175	10.20.0.23	Servers	XenServer   Xen Host	176	System	Healthy	CUG1	Active	Cisco SNMPv2 - Exa V2					

3. In the **Device Administration** panel, select the **Toolbox** tab.

Close	Properties	Thresholds	Collections	Monitors	Tickets	Redirects	Notes
Schedule	Logs	Toolbox	Interfaces	Relationships			
Device Name: WxGoos-1 - IT, Watchdogs, Inc. IP Address / ID: 10.20.0.228   78 Class: Generic Organization: System Collection Mode: Active Description: WxGoos-1 Device Hostname:		Managed Type: Physical Device Category: Unknown Sub-Class: SNMP Uptime: 0 days, 00:00:00 Collection Time: 2014-10-22 11:35:00 Group / Collector: CUG1   MOSS_ISO_CU					
Device Toolbox							
SSH	SNMP Walker	Port Scan	Deep Port Scan	Traceroute	Ping Tool	Forward DIG	Reverse DIG
ARP Lookup	ARP Ping	SNMP Dump	Web Policy				ARIN Whois
Toolbox Sessions Logs   Session Logs Found [ 0 ]							
Device	IP Address	Tool	Run Date	Run User	Session ID		

4. Depending on the device, the **Device Toolbox** page can display one or more of the following buttons. These tools run on the Data Collector that is currently monitoring the device unless otherwise noted:

- **FTP**. Opens a new browser window and attempts to make an FTP connection to the current device. This tool is initiated from the user's machine and does not run on a Data Collector. This tool appears only if the correct port (port 21) is detected as open by SL1.
- **SSH**. Opens an SSH session on the device. This tool is initiated from the user's machine and does not run on a Data Collector. This tool appears only if the correct port (port 22) is detected as open by SL1.

**NOTE:** The SSH tool is not available for SL1 systems that are configured as military unique systems.

- **Telnet**. Opens a browser session or terminal session using the IP address of the current device and prompts you for the telnet username and password. This tool is initiated from the user's machine and does not run on a Data Collector. This tool appears only if the correct port (port 23) is detected as open by SL1.
- **Terminal**. Opens the **Terminal Services Client Web Connection** modal page, where you can enter the login information for the terminal services session. This tool is initiated from the user's machine and does not run on a Data Collector. This tool appears only if the correct port (port 3389) is detected as open by SL1.
- **Web**. Opens a new browser window and attempts to make an http connection to the current device. This tool is initiated from the user's machine and does not run on a Data Collector.
- **Secure Web**. Opens a new browser window and attempts to make an HTTPS connection to the current device. This tool is initiated from the user's machine and does not run on a Data Collector. This tool appears only if the correct port (port 443) is detected as open by SL1.
- **SNMP Walker**. Opens the **SNMP Walker** modal page, where you can perform an SNMP walk on the device. If the device has an IPv6 address, SL1 will use the appropriate IPv6 SNMP command.
- **Port Scan**. Leads to the **Port Scan** modal page, where you can view a list of all open ports on the device at the time of the scan.
- **Deep Port Scan**. Leads to the **Deep Port Scan** modal page, where you can view a list of all open ports and view as much detail about each open port as the deep port scanner can retrieve.
- **Traceroute**. Leads to the **Traceroute** modal page, where you can view the network route between SL1 and the device. If the device has an IPv6 address, SL1 will use the appropriate IPv6 traceroute command.
- **Ping Tool**. Leads to the **Ping Tool** modal page, where you can view the statistics returned by the ping tool. The ping tool sends a packet to the device's IP address (the one used by SL1 to communicate with the device) and waits for a reply. SL1 then displays the number of seconds it took to receive a reply from the device and the number of bytes returned from the device. If the device has an IPv6 address, SL1 will use the appropriate IPv6 ping command.
- **Forward DIG**. Leads to the **Forward DIG** modal page, where you can view the output from the DIG utility. This tool automatically finds all available DNS information about the domain associated with the current device.

- **Reverse DIG**. Leads to the **Reverse DIG** modal page, where you can view the output from the reverse DIG utility. The reverse DIG tool retrieves the domain name that is associated with the device's IP.
- **ARIN Whois**. Leads to the **ARIN Whois** modal page, where you can view the output from the Whois utility. The Whois utility displays information about the device's IP, including the organization that registered the IP and contacts within that organization.
- **ARP Lookup**. Leads to the **ARP Lookup** modal page, where you can view the results from the ARP Lookup tool. The ARP Lookup tool displays a list IP addresses for the device and the resolved Ethernet or Token Ring physical addresses (MAC addresses) for each IP address.
- **ARP Ping**. Leads to the **ARP Ping** modal page, where you can view the results from the ARP Ping tool. The ARP Ping tool is similar in function to ping, but it operates using ARP instead of ICMP. The ARP Ping tool can be used only on the local network.
- **SNMP Dump**. Leads to the **SNMP Dump** modal page, where you can view the results of the SNMP Dump. The SNMP Dump tool retrieves each OID and its corresponding value from the device.
- **Web Policy**. Leads to the **Web Policy** modal page, where you can manually run a web-content policy on the device. This tool is initiated from the user's machine and does not run on the collector. This tool appears only if a Web Content Monitoring Policy has been configured for the device.

## Viewing the Session Logs

After you run a tool in the Device Toolbox, information about the session appears the **Toolbox Sessions Logs** pane (at the bottom of the page).





Device	IP Address	Tool	Run Date	Run User	Session ID
1. WxGoos-1 -- IT, Watchdogs, Inc.	10.20.0.228	SNMP Walker	2014-10-22 11:37:07	mantone	1

For each session, you can view the following:

- **Device**. Device associated with the session.

- **IP Address.** IP address that was polled by the session.
- **Tool.** Tool that was run.
- **Run Date.** Date the session occurred.
- **Run User.** User who initiated the session.
- **Session ID.** Unique numeric identifier automatically assigned to the session by SL1.

From the **Toolbox Sessions Logs** pane, you can also:

- View an SNMP Walk Session ()
- View raw data from the session ()
- Export raw data from the session to a file on the local computer ()
- Delete a session from the **Toolbox Sessions Logs** pane ()





## Managing Device Classes and Device Categories

---

### Overview

This chapter describes how to manage device classes and device categories in SL1.

Use the following menu options to navigate the SL1 user interface:

- To view a pop-out list of menu options, click the menu icon (.
- To view a page containing all of the menu options, click the Advanced menu icon (.

This chapter includes the following topics:

<b>Device Classes</b> .....	<b>138</b>
<i>Generic   SNMP Device Class</i> .....	139
<i>Non-SNMP Device Classes</i> .....	139
<i>Component Device Classes</i> .....	139
<i>Agent-Only Device Classes</i> .....	140
<i>Legacy ICMP Device Classes</i> .....	140
<b>Viewing the List of Device Classes</b> .....	<b>141</b>
<i>Viewing the List of Device Classes in the Classic SL1 User Interface</i> .....	141
Filtering the List of Device Classes .....	143
Special Characters .....	145
<b>Creating Device Classes</b> .....	<b>147</b>
<i>Creating a New Device Class of Type "SNMP-Enabled"</i> .....	148

Editing an SNMP-Enabled Device Class .....	151
Creating a New Device Class for a Device with Device Class "Generic   SNMP" .....	151
Creating a New Device Class for Devices That Do Not Support SNMP .....	155
Applying the New Device Class .....	160
Maintaining the New Device Class During Auto-Discovery .....	161
Editing a Device Class That is Not SNMP-Enabled .....	161
Creating a New Component Device Class .....	162
Editing a Component Device Class .....	163
<b>Managing Device Classes .....</b>	<b>163</b>
Manually Assigning a Device Class to a Device .....	164
Changing the Icon for a Device Class .....	164
<b>Managing Device Classes in the Classic SL1 User Interface .....</b>	<b>166</b>
Manually Changing the Device Class for a Device in the Classic SL1 User Interface .....	166
Changing the Icon for a Device Class in the Classic SL1 User Interface .....	168
Aligning One or More Device Classes with a Device Dashboard .....	169
Deleting One or More Device Classes .....	169
<b>Device Categories .....</b>	<b>170</b>
"Pingable" Device Category .....	170
<b>Viewing the List of Device Categories .....</b>	<b>171</b>
<b>Creating a New Device Category .....</b>	<b>172</b>
<b>Editing a Device Category .....</b>	<b>172</b>
<b>Duplicating a Device Category .....</b>	<b>173</b>
<b>Assigning an Icon to a Device Category .....</b>	<b>173</b>
<b>Managing Device Categories in the Classic SL1 User Interface .....</b>	<b>174</b>
Viewing the List of Device Categories in the Classic SL1 User Interface .....	175
Creating a New Device Category in the Classic SL1 User Interface .....	175
Editing a Device Category in the Classic SL1 User Interface .....	177
Deleting a Device Category .....	177
Aligning One or More Device Categories with a Device Dashboard .....	178

---

## Device Classes

Each device in SL1 is associated with a **device class**. Typically, device classes map to a make/model pair, such as *Product Name / Model Number*. SL1 includes already-defined device classes for the most popular hardware. When possible, SL1 automatically assigns each discovered device to an existing device class.

Device classes determine:

- How devices are represented in the user interface
- Whether the device is a physical device or a virtual device
- How managed devices are discovered with the discovery tool

SL1 includes already-defined device classes for the most popular hardware. The **Device Class Editor** page (System > Customize > Device Classes) allows advanced administrators to define new or legacy device classes in SL1 and to customize properties of existing device classes.

Most TCP/IP-compliant devices have an internally-defined class ID, called the System Object ID and abbreviated to SysObjectID. This SysObjectID is an SNMP OID defined by the manufacturer. Each manufacturer specifies a SysObjectID for each different hardware model. In SL1, each SNMP device class is associated with a SysObjectID. During initial discovery, SL1 searches each device for the SysObjectID and assigns each device to the appropriate device class.

SL1 also includes device classes for devices that do not support SNMP. These device classes are associated with values returned by nmap. SL1 runs nmap against each device during discovery.

The following sections describe the types of device classes used in SL1.

## Generic | SNMP Device Class

SL1 includes a default device class for devices that include a SysObjectID but for which SL1 does not have an aligned device class. This device class is **Generic | SNMP**.

For each device with a device class of **Generic | SNMP**, you can use SL1 to view the SysObjectID for the device and then define a new device class using that SysObjectID.

## Non-SNMP Device Classes

SL1 also includes device classes for devices that do not support SNMP. Devices that do not support SNMP are sometimes referred to as "pingable". Devices that have a device category of "pingable" are devices that meet one of the following criteria:

- The device does not support SNMP.
- SNMP has been disabled on the device.
- The incorrect credential was provided during discovery and "Discover Non-SNMP" was enabled for the discovery session.

SL1 can use nmap to match a "pingable" device to an appropriate "pingable" device class.

## Component Device Classes

SL1 includes device classes for component devices. SL1 discovers management systems and the component devices they manage. SL1 uses Dynamic Applications to retrieve data from a management system and discover each component device managed by that management system. Device classes for components are aligned with the Dynamic Applications that discover component devices.

## Agent-Only Device Classes

SL1 includes device classes for devices that are monitored by the SL1 agent and are not monitored via SNMP.

During initial discovery, the agent returns operating system type and version information to SL1.

Based on this information, SL1 assigns the corresponding device classes to a device monitored only by an agent.

**NOTE:** If a device is monitored by an agent and via SNMP, the device class assigned by SNMP discovery will take precedence.

## Legacy ICMP Device Classes

SL1 includes legacy device classes of type **SNMP Enabled** for "pingable" devices (that is for devices that don't support SNMP). SL1 includes the following legacy, **SNMP Enabled** device classes for "pingable" devices:

- Cisco Systems | ICMP
- FreeBSD | ICMP
- Linux | ICMP
- Microsoft | ICMP
- Novell | ICMP
- Ping | ICMP
- Sun Microsystems | ICMP
- Tektronix, Inc. | ICMP

**NOTE:** Best practice is to define "pingable" devices as those that do not support SNMP. For "pingable" devices that do not support SNMP, ScienceLogic recommends you use the new "deep discovery" feature and then create device classes of type "pingable".

## Viewing the List of Device Classes

On the **Device Classes** page (Devices > Device Classes), you can view a list of existing device classes in SL1.

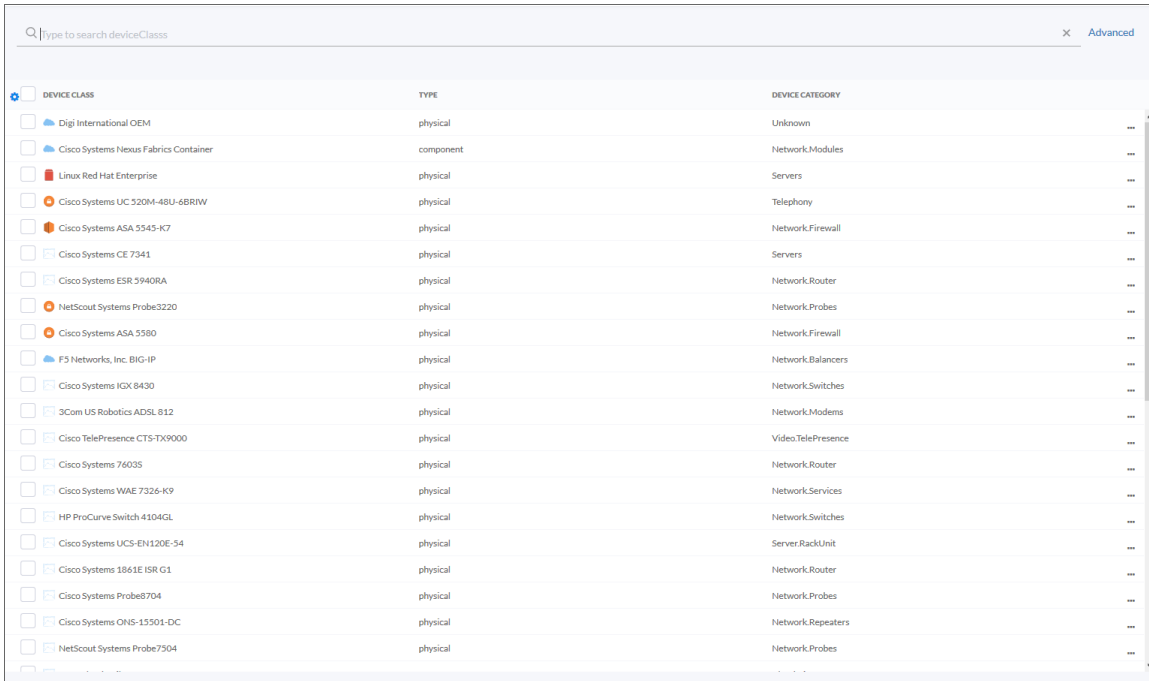

DEVICE CLASS	TYPE	DEVICE CATEGORY
Digi International OEM	physical	Unknown
Cisco Systems Nexus Fabrics Container	component	Network.Modules
Linux Red Hat Enterprise	physical	Servers
Cisco Systems UC 520M-4BU-6BRIW	physical	Telephony
Cisco Systems ASA 5545-K7	physical	Network.Firewall
Cisco Systems CE 7341	physical	Servers
Cisco Systems ESR 5940RA	physical	Network.Router
NetScout Systems Probe3220	physical	Network.Probes
Cisco Systems ASA 5580	physical	Network.Firewall
FS Networks, Inc. BIG-IP	physical	Network.Balancers
Cisco Systems IXG 8430	physical	Network.Switches
3Com US Robotics ADSL 812	physical	Network.Modems
Cisco TelePresence CTS-TX9000	physical	Video.TelePresence
Cisco Systems 7603S	physical	Network.Router
Cisco Systems WAE 7326-K9	physical	Network.Services
HP ProCurve Switch 4104GL	physical	Network.Switches
Cisco Systems UCS-EN120E-54	physical	Server.RackUnit
Cisco Systems 1861E ISR G1	physical	Network.Router
Cisco Systems Probe8704	physical	Network.Probes
Cisco Systems ONS-15501-DC	physical	Network.Repeaters
NetScout Systems Probe7504	physical	Network.Probes

For each device class, the **Device Classes** page displays the following information:

- **Device Class.** The name of the device class.
- **Type.** The device type. Can be "physical", "virtual", or "component".
- **Device Category.** The device category. A device category is a way to categorize devices by primary function. SL1 uses device categories to group related devices in reports and views. The list of device categories is defined in the **Device Category Editor** page (System > Customize > Device Categories).
- **Model.** The device model.
- **Vendor.** The device manufacturer.

**TIP:** To rearrange the columns in the List View, click and drag the column name to a new location. You can adjust the width of a column with by clicking and dragging the right edge of the column. You can click the **Select Columns** icon (⚙️) to add or remove columns, or to reset columns to their default settings.

## Viewing the List of Device Classes in the Classic SL1 User Interface

The **Device Class** page displays a list of existing device classes in the **Device Class Register** pane.

To view the list of device classes:

1. Log in to SL1.
2. Go to the **Device Class** page (System > Customize > Device Classes).

The screenshot shows the 'Device Class Editor' interface. It has several configuration panels:
 

- Device Type:** SNMP Enabled (dropdown), Root Device (checkbox), Device Class Tier (dropdown), Weight (dropdown).
- Device Class:** Discovery Identifier (SysObjectID) (text input), Discovery Qualifier (SNMP OID) (text input), Tabular (checkbox), Qualifier Match (Value) (text input).
- Description:** Description (text input), Device Icon (dropdown: [\_generic\_unknown.png]), All in Class (checkbox), Device Category (dropdown: [Servers Search]), All in Class (checkbox), System Uptime OID (dropdown: [sysUptime (1.3.6.1.2.1.1.3.0)]).
- Correlation Method:** Correlation Method (dropdown: [n/a]), Collection Type (dropdown: [Physical Device (Enabled)]), PDU Packing (checkbox), Process Collection (dropdown: [n/a]), Service Collection (dropdown: [n/a]).
- Agent Identifier:** Agent Identifier 1 (text input), Agent Identifier 2 (text input), Device Dashboard (dropdown: [None]), L3 Topology (checkbox), Interface Index Change Detection (checkbox), Save button.

 Below the editor is the 'Device Class Register' table with 12 rows of data.

Device Class	Description	Device Category	Device Class Tier	Class ID	Collection Type	Process Collection	Device Dashboard	PowerPack	Device Icon	Discovery Identifier	Subs
1. 10xlarge	AWS EC2 Instance Cloud Compute		No Tier	791	Component	n/a	--	Yes	ec2-10xl.png	AwsEc2Instance	--
2. 2Wire	OEM Unknown		No Tier	4140	Physical	n/a	--	Yes	_generic_unknown.png	1.3.6.1.4.1.4839	--
3. 2xlarge	AWS EC2 Instance Cloud Compute		No Tier	781	Component	n/a	--	Yes	ec2-2xl.png	AwsEc2Instance	--
4. 3Com	11Mbps Wlan Wireless		No Tier	668	Physical	n/a	--	Yes	3com.png	1.3.6.1.4.1.43.1.20.2	--
5. 3Com	2000 Termin Network Terminals		No Tier	634	Physical	n/a	--	Yes	3com.png	1.3.6.1.4.1.43.1.1.3	--
6. 3Com	210 Termin Network Terminals		No Tier	636	Physical	n/a	--	Yes	3com.png	1.3.6.1.4.1.43.1.1.5	--
7. 3Com	2100 Termin Network Terminals		No Tier	637	Physical	n/a	--	Yes	3com.png	1.3.6.1.4.1.43.1.1.6	--
8. 3Com	2500 Termin Network Terminals		No Tier	632	Physical	n/a	--	Yes	3com.png	1.3.6.1.4.1.43.1.1.1	--
9. 3Com	2600 Termin Network Terminals		No Tier	633	Physical	n/a	--	Yes	3com.png	1.3.6.1.4.1.43.1.1.2	--
10. 3Com	3000 Termin Network Terminals		No Tier	638	Physical	n/a	--	Yes	3com.png	1.3.6.1.4.1.43.1.1.7	--
11. 3Com	3100 Termin Network Terminals		No Tier	639	Physical	n/a	--	Yes	3com.png	1.3.6.1.4.1.43.1.1.8	--
12. 3Com	3com Corp. Network Switches		No Tier	692	Physical	n/a	--	Yes	3com.png	1.3.6.1.4.1.43.1.16.2.2.3.1	--

3. For each device class, the **Device Class Register** pane displays:

**TIP:** To sort the list of device classes, click on a column heading. The list will be sorted by the column value, in ascending order. To sort by descending order, click the column heading again.



- **Device Class Name.** Name of the device class.
- **Description.** Description of the device class. If the device class is for an entire manufacturer, rather than for a specific product, the description will contain the value "OEM".

**NOTE:** If you see a device class of **Ping | ICMP** or a device with a device category of **pingable**, this means that the device does not support SNMP, that SNMP has been disabled on the device, or that the wrong SNMP credential was provided during discovery.

**NOTE:** If you see a device class of **Generic | SNMP**, this means that SL1 discovered a SysObjectID for the device, but SL1 does not include a device class that aligns with that SysObjectID.

- **Device Category.** The device category. A device category is a way to categorize devices by primary function. SL1 uses device categories to group related devices in reports and views. The list of device categories is defined in the **Device Category Editor** page (System > Customize > Device Categories).
- **Device Class Tier.** A read-only field that displays the device tier for subscription billing. The device class tier allows you to calculate the "cost" (according to your license) of each device. By default, this field displays "Standard Device". If you are using a subscription model for billing, this field will display the license tier for the device class.

**NOTE:** If you create a custom device class, please contact ScienceLogic Customer Support to define the device class tier for the new device class.

- **Class ID.** Unique numeric ID, automatically assigned to the device class by SL1.
- **Collection Type.** Device type. Can be "physical", "virtual", or "component".
- **Process Collection.** Specifies the application that maintains process information for the device. SL1 will poll this application for information on the system processes. Choices are:
  - *n/a.* Don't monitor processes.
  - *Host Resource.* MIB that provides information on processes.
  - *HP/UX.* Specifies that HP agents will provide information on processes.
  - *Solaris (prior to Solaris 10).* Specifies that Solaris agents will provide information on processes.
  - *Extended User Information.* Specifies that ScienceLogic's custom extension to net-SNMP will provide process information. Users must have installed the extension before selecting this option.
- **Device Dashboard.** This field displays the device dashboard associated with the device class.
- **PowerPack.** This field specifies whether or not this device class is included in a PowerPack.
- **Device Icon.** The icon associated with the device class. To view the icon, select the picture icon (.
- **Discovery Identifier.** An SNMP OID defined by the manufacturer. Usually, a hardware manufacturer specifies a SysObjectID for each different hardware model.
- **Subs.** Specifies if one or more devices are aligned with the device class. If so, the devices icon () appears in this column. Selecting the devices column leads to the **Subscribers** modal page, where you can view a list of devices that are aligned with the device class.

## Filtering the List of Device Classes

You can filter the list on the Device Class Editor page by one or more parameters. Only device classes that meet all the filter criteria will be displayed in the Device Class Editor page.

For each filter except *Collection Type*, enter text into the desired filter-while-you-type field. The **Device Class Editor** page searches for device classes that match the text, including partial matches. By default, the cursor is placed in the left-most filter-while-you-type field. You can use the <Tab> key or your mouse to move your cursor through the fields. The list is dynamically updated as you type. Text matches are not case-sensitive.

You can also use [special characters](#) to filter each parameter.

Filter by one or more of the following parameters:

- **Device Class.** You can enter text to match, including special characters, and the **Device Class Editor** page will display only devices that have a matching device class name.
- **Description.** You can enter text to match, including special characters, and the **Device Class Editor** page will display only devices that have a matching description name.
- **Device Category.** You can enter text to match, including special characters, and the **Device Class Editor** page will display only devices that have a matching device category name.
- **Device Class Tier.** You can enter text to match, including special characters, and the **Device Class Editor** page will display only devices that have a matching device class tier.
- **Class ID.** You can enter text to match, including special characters, and the **Device Class Editor** page will display only devices that have a matching class ID.
- **Collection Type** Specifies the device class's collection type. Only those devices that match all the previously selected fields and have the specified collection type will be displayed. The choices are:
  - *All.* Include device classes that have a Collection Type of physical and virtual.
  - *Physical.* Include only device classes that have a Collection Type of physical.
  - *Virtual.* Include only device classes that have a Collection Type of virtual.
- **Device Dashboard.** You can enter text to match, including special characters, and the **Device Class Editor** page will display only devices that have a matching device dashboard.
- **Process Collection.** You can enter text to match, including special characters, and the **Device Class Editor** page will display only devices that have a matching process collection type.
- **PowerPack.** You can enter text to match, including special characters, and the **Device Class Editor** page will display only devices that have a matching PowerPack value.
- **Device Icon.** You can enter text to match, including special characters, and the **Device Class Editor** page will display only devices that have a matching device icon name.
- **Discovery Identifier.** You can enter text to match, including special characters, and the **Device Class Editor** page will display only devices that have a matching discovery identifier.
- **Subs.** You can enter text to match, including special characters, and the **Device Class Editor** page will display only devices that have a matching subs value.



## Special Characters

When filtering a list in a registry page, you can include the following special characters to search each field except those that display date and time:

**NOTE:** When searching for a string, SL1 will match substrings by default, even if you do not include any special characters. For example, searching for "he" will match both "hello" and "helicopter". When searching for a numeric value, SL1 will not match a substring unless you use a special character.

Special Character	Description	Example
, (comma)	(For strings or numeric values) Specifies an OR operation.	"dell,micro" would match all values that contain the string "dell" OR the string "micro".
& (ampersand)	(For strings or numeric values) Specifies an AND operation.	"dell&micro" would match all values that contain both the string "dell" AND the string "micro", in any order.
! (exclamation point)	(For strings or numeric values) Specifies a NOT operation. <b>NOTE:</b> You can also use the "!" character in combination with the arithmetic special characters (min-max, >, <, >=, <=, =) described below.	"!dell" would match all values that do not contain the string "dell".
* (asterisk)	(For strings or numeric values) Specifies a "match-zero-or-more" operation.  For a string, matches any string that matches the text before and after the asterisk. For a numeral, matches any numeral that contains the text.	<ul style="list-style-type: none"> <li>"hel*er" would match "helpers" and "helicopter" but not "hello".</li> <li>"325*" would match "325", "32561", and "325000".</li> <li>"*000" would match "1000", "25000", and "10500000".</li> </ul>
? (question mark)	(For strings or numeric values) Specifies a "match any one character" operation.	<ul style="list-style-type: none"> <li>"l?ver" would match the strings "oliver", "levers", and "liver", but not "believers".</li> <li>"135?" would match the numbers "1350", "1354", and "1359", but not "13502".</li> </ul>
^ (caret)	(For strings only) Specifies a "match the beginning" operation. Matches any string that begins with the specified string.	"^sci" would match "scientific" and "sciencelogic", but not "conscious".
\$ (dollar)	(For strings only) Specifies "match the ending". Matches any string that ends with the specified string.	"ter\$" would match the string "renter" but not the string "terrific".

Special Character	Description	Example
	<b>NOTE:</b> You can use both ^ and \$ if you want to match an entire string. For example, "^tern\$" would match the strings "tern" or "Tern" or "TERN"; it would not match the strings "terne" or "cistern".	
min-max	(For numeric values only) Matches any value between the specified minimum value and the maximum value, including the minimum and the maximum.	"1-5" would match 1, 2, 3, 4, and 5.
- (dash)	(For numeric values only) A "half open" range. Matches values including the specified minimum and greater, or including the specified maximum and lesser.	<ul style="list-style-type: none"> <li>"1-" matches 1 and greater, so it would match 1, 2, 6, 345, etc.</li> <li>"-5" matches 5 and less, so it would match 5, 3, 1, 0, etc.</li> </ul>
> (greater than)	(For numeric values only) Matches any value greater than the specified value.	">7" would match all values greater than 7.
< (less than)	(For numeric values only) Matches any value less than the specified value.	"<12" would match all values less than 12.
>= (greater than or equal to)	(For numeric values only) Matches any value that is equal to or greater than the specified value.	">=7" would match all values 7 and greater.
<= (less than or equal to)	(For numeric values only) Matches any value that is equal to or less than the specified value.	"<=12" would match all values 12 and less.
= (equal)	(For numeric values only) Matches a value that is equal to the specified value.  You can also use this special character to match a negative value, as demonstrated in the example.	"=-5" would match "-5" instead of being evaluated as the "half open range" as described above.

## Creating Device Classes

The following sections describe how to create new device classes for:

- [Devices that support SNMP](#)
- [Devices with Device Class "Generic | SNMP"](#)
- [Devices that do not support SNMP](#)
- [Devices with a Device Class of "Component"](#)

# Creating a New Device Class of Type "SNMP-Enabled"

In the **Device Class Editor** page, you can define a new device class. SL1 can then use this device class during discovery and users can assign this device class to devices.

**NOTE:** You can use an existing device class as a template when defining a new device class. To do this, follow the steps in the Editing an [SNMP-Enabled Device Class](#) section, but supply a new name in the **Device Class** field and click **[Save As]** to save your changes.

**NOTE:** The **Device Class Tier** is a read-only field that is automatically populated by the subscription billing process. If you create a custom device class, please contact ScienceLogic Customer Support to define the **Device Class Tier** for the new device class.

When you create a new device class of type **SNMP Enabled**, you are defining a device class that uses the **SNMP SysObjectID** to identify member device.

To create a new device class of type **SNMP Enabled**:

1. Go to the **Device Class Editor** page (System > Customize > Device Classes).
2. Click **[Reset]** to clear the fields in the **Device Class Editor** pane.
3. Select **SNMP Enabled** in the **Device Type** drop-down list. You can now define the value in the following fields:

The screenshot shows the **Device Class Editor** interface. The top section contains several configuration panels:

- Device Type:** Set to "SNMP Enabled".
- Device Class:** A text input field.
- Description:** A text input field.
- Correlation Method:** A dropdown menu.
- Agent Identifier 1 & 2:** Text input fields.
- Device Dashboard:** A dropdown menu.
- L3 Topology:** A checkbox.
- Interface Index Change Detection:** A checkbox.
- Save:** A button.

Below the configuration panels is the **Device Class Register** table, which lists existing device classes. The table has columns for Device Class, Description, Device Category, Device Class Tier, Class ID, Collection Type, Process Collection, Device Dashboard, PowerPack, Device Icon, Discovery Identifier, and Sub.

Device Class	Description	Device Category	Device Class Tier	Class ID	Collection Type	Process Collection	Device Dashboard	PowerPack	Device Icon	Discovery Identifier	Sub
10xlarge	AWS EC2 I Cloud Compute		No Tier	791	Component	n/a	--	Yes	ec2-10xl.png	AwsEc2Instance	--
2Wire	OEM	Unknown	No Tier	4140	Physical	n/a	--	Yes	generic_unknown.png	1.3.6.1.4.1.4839	--
2xlarge	AWS EC2 I Cloud Compute		No Tier	781	Component	n/a	--	Yes	ec2-2xl.png	AwsEc2Instance	--
3Com	11Mbps Wirt Wireless		No Tier	698	Physical	n/a	--	Yes	3com.png	1.3.6.1.4.1.43.1.20.2	--
3Com	2000 Termini Network Terminals		No Tier	634	Physical	n/a	--	Yes	3com.png	1.3.6.1.4.1.43.1.1.3	--
3Com	210 Termini Network Terminals		No Tier	636	Physical	n/a	--	Yes	3com.png	1.3.6.1.4.1.43.1.1.5	--
3Com	2100 Termini Network Terminals		No Tier	637	Physical	n/a	--	Yes	3com.png	1.3.6.1.4.1.43.1.1.6	--
3Com	2500 Termini Network Terminals		No Tier	632	Physical	n/a	--	Yes	3com.png	1.3.6.1.4.1.43.1.1.1	--
3Com	2600 Termini Network Terminals		No Tier	633	Physical	n/a	--	Yes	3com.png	1.3.6.1.4.1.43.1.1.2	--
3Com	3000 Termini Network Terminals		No Tier	638	Physical	n/a	--	Yes	3com.png	1.3.6.1.4.1.43.1.1.7	--
3Com	3100 Termini Network Terminals		No Tier	639	Physical	n/a	--	Yes	3com.png	1.3.6.1.4.1.43.1.1.8	--
3Com	3com Corp. Network Switches		No Tier	692	Physical	n/a	--	Yes	3com.png	1.3.6.1.4.1.43.1.16.2.2.3.1	--

- **Root Device.** If selected, this checkbox specifies that this device can have children devices. Ensures that root devices are included in nightly re-discovery.

- **Weight.** If two device-class definitions are similar, a device might meet the criteria for both device classes. In this case, the **Weight** field tells SL1 which device class to align with the device. The **Weight** field allows you to define both detailed, non-SNMP device-class definitions, as well as less detailed, catch-all device classes.

SL1 will align the device with the device-class definition with the lowest weight. If a device matches two device-class definitions, and both device classes have the same weight, SL1 will align the device with the device class that appears first in the alphabetical list of device classes.

For example, you could define a detailed device class with a weight of "1" and a similar but less detailed device class with a weight of "10". SL1 will first try to assign a discovered device to the device class with a weight of "1". If the device does not meet the criteria for that device class, SL1 will then try to assign the discovered device to the device class with a weight of "10".

- **Device Class.** The name of the manufacturer who created the device and/or agent. Can be any combination of alphanumeric characters, up to 48 characters in length.
- **Discovery Identifier (SysObjectID).** The SNMP OID, in numeric form, that is returned when querying the device's sysObjectID. Can be up to 64 characters in length. Refer to the appropriate MIB file to determine this value.

**NOTE:** To view a list of OIDs associated with companies, organizations, and manufacturers, see <http://www.iana.org/assignments/enterprise-numbers>

- **Discovery Qualifier (SNMP OID).** Optional field. Secondary SNMP OID, in numeric form, used to further qualify device types. Can be up to 255 characters in length. If a device matches both the **Discovery Identifier** and responds to the **Discovery Qualifier**, the device will be assigned to the device class.
- **Tabular.** If you want to use a tabular value in the **Discovery Qualifier** field, select this checkbox. When you select this checkbox, SL1 will perform an SNMP walk of the **Discovery Qualifier** (as opposed to an SNMP "get" request) and then search for the value that matches the **Qualifier Match** field.
- **Qualifier Match.** Optional field. String that must be present in returned value for the **Discovery Qualifier** OID. If a device matches the **Discovery Identifier**, responds to the **Discovery Qualifier**, and the response matches the **Qualifier Match**, the device will be assigned to the device class. Can be up to 64 characters in length.
- **Description.** The model name of the device. Can be any combination of alphanumeric characters, up to 48 characters in length. For ease-of-use, ScienceLogic recommends that you follow this convention: If you are creating a device class for an entire manufacturer, rather than for a specific product, enter "OEM" as the device description.
- **Device Icon.** The icon used to display the device in the graphical interface. To view the available icons, click [**Icons**]. Select an icon from the drop-down list.
- **All in class.** Selecting this checkbox updates the device icon for all existing members of the device class.

- **Device Category.** A logical categorization of device by primary function. This field allows SL1 to group related devices in reports and views. Select a value from the drop-down list.
- **All in class.** Selecting this checkbox updates the device category for all existing members of the device class.
- **System Uptime OID.** Specifies the OID to monitor to determine system uptime. Choices are:
  - *sysUpTime (.1.3.6.1.2.1.1.3.0).* EM7 Default. From the System group of MIB RFC 1213. Returns uptime of the device's SNMP Agent. The time (in hundredths of a second) since the network management portion of the system was last re-initialized.
  - *hrSystemUptime (.1.3.6.1.2.1.25.1.1.0).* From the HR-MIB. The amount of time since this host was last initialized.
  - Any additional OIDs defined in the **System Uptime OIDs** page (System > Customize > Uptime OIDs).
- **Correlation Method.** Used for special topological correlation. Allows SL1 to support event correlation and mapping for VMware and Microsoft hypervisors.
- **Collection Type.** Specifies whether the device is a hardware-based device (physical) or a virtual device.
- **PDU Packing.** If your managed network includes a large number of interfaces, and you want to monitor those interfaces, select this checkbox. PDU packing enables quicker collection of interface data.
- **Process Collection.** Specifies how SL1 will retrieve process information for the device. SL1 will use this method to gather information on the system processes. Choices are:
  - *n/a.* Don't monitor processes.
  - *Host Resource.* Specifies that the Host Resources MIB will be used to collect information on processes.
  - *HP/UX.* Specifies that HP agents will provide information on processes.
  - *Solaris (prior to Solaris 10).* Specifies that Solaris agents will provide information on processes.
  - *Extended User Information.* Specifies that ScienceLogic's custom extension to net-SNMP will provide process information. Users must have installed the extension before selecting this option.
- **Service Collection.** Specifies how to collect information on Windows services. Choices are:
  - *n/a.* This is not a Windows device class.
  - *Windows Basic.* Use the Windows MIB to gather information about Windows services.
  - *WMI Informant.* Use the WMI Informant MIB to gather information about Windows services.
- **Agent Identifier 1 and Agent Identifier 2:** These fields are used to align device classes to devices using the SL1 agent. Device classes exist for every possible combination of values returned by the agent; you do not need to enter or change values in these fields when creating or editing a device class.



- **Device Dashboard.** Select a device dashboard from a list of all device dashboards in SL1. For devices with this device class, the selected device dashboard will appear as an option in the **Device Summary** page. This field is optional.
  - **L3 Topology.** If selected, SL1 includes devices in this device class in the **Layer-3 Maps** page (Classic Maps > Topology Maps > Layer-3). SL1 uses traceroute from each Data Collector to each managed device to create Layer-3 maps.
  - **Interface Index Change Detection.** On some devices, the SNMP index of an interface can change when the interface goes down and then comes back up. If you select this checkbox, SL1 will use the combination of interface ID and ifPhysAddress to monitor interfaces on devices that use this device class and to align events with those interfaces.
4. Click **[Save]** to save the new device class or click **[Save As]** to save your changes under a new device class name.

## Editing an SNMP-Enabled Device Class

In the **Device Class Editor** page, you can edit a device class for a device that supports SNMP.

When you **select SNMP Enabled**, you are defining a device class that uses the **SNMP SysObjectID** to identify member devices.

To edit an existing device class:

1. Go to the **Device Class Editor** page (System > Customize > Device Classes), or from the **Device Properties** page, select the pencil icon (.
2. In the **Device Class Register** pane at the bottom of the page, find the device class you want to edit. Select its wrench icon (.
4. The fields in the top pane will be populated with values from the selected device class. You can edit one or more of the fields described in the section [Creating a New Device Class for Devices That Support SNMP](#).
5. Select the **[Save]** button to save your changes to the device class or select the **[Save As]** button to save your changes under a new device class name.

## Creating a New Device Class for a Device with Device Class "Generic | SNMP"

After discovery, SL1 might discover devices and assign those devices to the device class **Generic | SNMP**. This means that SL1 was able to retrieve a SysObjectID value from the device, but SL1 does not include a Device Class for that SysObjectID.

**NOTE:** The **Device Class Tier** is a read-only field that is automatically populated by the subscription billing process. If you create a custom device class, please contact ScienceLogic Customer Support to define the **Device Class Tier** for the new device class.

To create a new device class for a device with device class **Generic | SNMP**, perform the following:

1. Go to the **Device Manager** page (Devices > Device Manager).
2. In the **Device Manager** page, find the device with the device class **Generic | SNMP**. Select the wrench icon () for the device.

Device Manager   Devices Found [176]										Actions	Report	Reset	Guide	
Device Name	IP Address	Device Category	Device Class   Subclass	OID	Organization	Current State	Collection Group	Collection State	SNMP Credential	SNMP Version				
151 Server-01	10.20.0.177	Office Printers	Lexmark International   Print Server	42	System	Minor	CUG1	Active	Cisco SNMPv2 - Exa V2					
152 ShorelineSwitch	10.20.0.214	Unknown	Shoreline Networks   OEM	15	System	Healthy	CUG1	Active	Cisco SNMPv2 - Exa V2					
153 SimpleSoft.qa.ScienceLogic.local	10.20.0.7	Servers	Microsoft   Windows Server 2008 R2	77	System	Minor	CUG1	Active	cbasm5 V2					
154 SNAP562146	10.20.0.249	Storage.NAS	Quantum Corp - Snap Division   Snap Server	158	System	Minor	CUG1	Active	Cisco SNMPv2 - Exa V2					
155 SNS-PHX-MDC1-Texas	10.20.0.247	Network.Switches	Juniper Networks   M71 Router	152	System	Healthy	CUG1	Active	Cisco SNMPv2 - Exa V2					
156 SQR23330X	10.20.0.180	Servers	Microsoft   Windows CE Version 3.0 (Multiple	27	System	Healthy	CUG1	Active	Cisco SNMPv2 - Exa V2					
157 Summit-1	10.20.0.92	Network.Switches	Extreme Networks   Summit46s1 Version 7.1.1	101	System	Healthy	CUG1	Active	Cisco SNMPv2 - Exa V2					
158 Sunprod1	10.20.0.27	Servers	NET-SNMP   Solaris	169	System	Major	CUG1	Active	Cisco SNMPv2 - Exa V2					
159 Svrsvr_MonmouthJunctUSA	10.20.0.210	Telephony	Quantum   Tenor A800	18	System	Healthy	CUG1	Active	Cisco SNMPv2 - Exa V2					
160 SW2750RAC1_NewGA	10.20.0.1	Network.Switches	Cisco Systems   Catalyst 3750-Slack	76	System	Healthy	CUG1	Active	Cisco SNMPv2 - Exa V2					
161 Swtch	10.20.0.15	Network.Switches	Brocade   Chameleon Switch	164	System	Healthy	CUG1	Active	Cisco SNMPv2 - Exa V2					
162 Tandberg	10.20.0.217	Unknown	Tandberg ASA   OEM	12	System	Healthy	CUG1	Active	Cisco SNMPv2 - Exa V2					
163 Tigrisakic-fw0.ra1.hostedsolutions.com	10.20.0.157	Network.Firewall	Cisco Systems   ASA 5520	146	System	Minor	CUG1	Active	Cisco SNMPv2 - Exa V2					
164 TOSHIBA-e-STUD0451c	10.20.0.86	Unknown	Tec Corporation   OEM	124	System	Minor	CUG1	Active	Cisco SNMPv2 - Exa V2					
165 TICcum	10.20.0.229	Unknown	Norco   OEM	81	System	Minor	CUG1	Active	Cisco SNMPv2 - Exa V2					
166 ts2.local	10.20.0.71	Network.Switches	Cisco Systems   TS SEC	68	System	Healthy	CUG1	Active	Cisco SNMPv2 - Exa V2					
167 ts3.local	10.20.0.72	Network.Switches	Cisco Systems   TS SEC	67	System	Healthy	CUG1	Active	Cisco SNMPv2 - Exa V2					
168 TULLPT15-ACCOUNTING	10.20.0.168	Unknown	HP   OEM	166	System	Minor	CUG1	Active	Cisco SNMPv2 - Exa V2					
169 UPR1.rvr.ba	10.20.0.77	Environmental(UPS)	APC   SmartUPS 2200	86	System	Critical	CUG1	Active	Cisco SNMPv2 - Exa V2					
170 VTI000	10.20.0.166	Unknown	General Instrument   OEM	55	System	Healthy	CUG1	Active	Cisco SNMPv2 - Exa V2					
171 vxTarget	10.20.0.227	Telephony	Vina Technologies   Multiplexor	136	System	Healthy	CUG1	Active	Cisco SNMPv2 - Exa V2					
172 wrbdb-prod1	10.20.0.64	Servers	Empire Technologies   Default Enterprise Agent	87	System	Critical	CUG1	Active	Cisco SNMPv2 - Exa V2					
173 WILLIAMS-CORE-R01	10.20.0.62	Network.Router	Cisco Systems   4454	83	System	Minor	CUG1	Active	Cisco SNMPv2 - Exa V2					
174 WDC0001-TT-Watchdogs, Inc.	10.20.0.220	Unknown	Generic   SNMP	78	System	Healthy	CUG1	Active	Cisco SNMPv2 - Exa V2					
175 wdxsensv134	10.20.0.23	Servers	NetServer   NetServer	176	System	Healthy	CUG1	Active	Cisco SNMPv2 - Exa V2					



- In the **Device Administration** panel, select the **[Toolbox]** tab.

Close	Properties	Thresholds	Collections	Monitors	Tickets	Redirects	Notes
Schedule	Logs	<b>Toolbox</b>	Interfaces	Relationships			

Device Name	WxGoos-1 -- I.T. Watchdogs, Inc.	Managed Type	Physical Device
IP Address / ID	10.20.0.228   78	Category	Unknown
Class	Generic	Sub-Class	SNMP
Organization	System	Uptime	0 days, 00:00:00
Collection Mode	Active	Collection Time	2014-10-22 11:35:00
Description	WxGoos-1	Group / Collector	CUG1   MOSS_ISO_CU
Device Hostname			

Device Toolbox									Actions	Reset	Guide
SSH	SNMP Walker	Port Scan	Deep Port Scan	Traceroute	Ping Tool	Forward DIG	Reverse DIG	ARIN Whois			
ARP Lookup	ARP Ping	SNMP Dump	Web Policy								

Toolbox Sessions Logs   Session Logs Found [ 0 ]					
Device	IP Address	Tool	Run Date	Run User	Session ID

- In the **Device Toolbox** page, select the icon for SNMP Walker.

5. In the **SNMP Walker** modal page, go to the drop-down menu in the upper left and select **System MIB**. Then select the **[Walk]** button.

The screenshot shows the SNMP Walker interface for device WxGoos-1. The table below displays the returned values for various MIB objects. The value 1.3.6.1.4.1.17373 is highlighted in a red box.



Returned OID	Returned Value
1.3.6.1.2.1.1.1.0	WxGoos-1
1.3.6.1.2.1.1.2	1.3.6.1.4.1.17373
1.3.6.1.2.1.1.3.0	
1.3.6.1.2.1.1.4.0	support@twatchdogs.com/512.257.1462
1.3.6.1.2.1.1.5.0	WxGoos-1 -- LT. Watchdogs, Inc.
1.3.6.1.2.1.1.6.0	//www.twatchdogs.com
1.3.6.1.2.1.1.7.0	92

6. The second entry in the **Returned Value** column is the SysObjectID. In the example above, that value is **1.3.6.1.4.1.303.3.3.7.3**. Copy this value and save it in a document or write down this value. You will need it to create a new device class.
7. Follow the directions in the section [Creating a New Device Class of type "SNMP-Enabled"](#). In the **Discovery Identifier** field, enter the value of the SysObjectID from the SNMP Walker. Make sure there are no blank spaces before or after the SysObjectID value.
8. To assign the new device class to a device, follow the instructions in the section [Manually Changing the Device Class for a Device](#).

- Alternately, you can re-discover the device with the device class "Generic | SNMP". To re-discover the device, go to the **Device Manager** page (Devices > Device Manager). Find the device you want to re-discover. Select its wrench icon () . In the **Device Properties** page for the device, select the binoculars icon () .

Close	Properties	Thresholds	Collections	Monitors	Schedule	Logs	Toolbox	Interfaces	Relationships	Tickets	Redirects	Notes
Device Name	10.20.0.175	Managed Type	Physical Device									
IP Address / ID	10.20.0.175   62	Category	Unknown									
Class	Generic	Sub-Class	SNMP									
Organization	System	Uptime	0 days, 00:00:00									
Collection Mode	Active	Collection Time	2014-06-12 17:20:00									
Description		Group / Collector	CUG2   em7_cu2									
Device Hostname												

Device Properties		Organization	Asset	
		Actions	Reset	Guide
<b>Identification</b>				
Device Name	10.20.0.175 	IP Address	[10.20.0.175 - verified] +	
		Organization	[System] 	
<b>Monitoring &amp; Management</b>		<b>Preferences</b>		
Device Class	Generic SNMP 	Auto-Clear Events	<input checked="" type="checkbox"/>	
SNMP Read/Write	[Cisco SNMPv2 - Example] [None]	Accept All Logs	<input checked="" type="checkbox"/>	
Availability Port	[UDP] [161 - SNMP]	Daily Port Scans	<input checked="" type="checkbox"/>	
Latency Port	[ICMP] [ICMP]	Auto-Update	<input checked="" type="checkbox"/>	
Avail+Latency Alert	[Disable]	Scan All IPs	<input type="checkbox"/>	
User Maintenance	[Disabled] [Maintenance Collection Enabled]	Dynamic Discovery	<input checked="" type="checkbox"/>	
Collection	[Enabled] [CUG2]	Preserve Hostname	<input checked="" type="checkbox"/>	
Coll. Type	[Standard]	Disable Asset Update	<input type="checkbox"/>	
Critical Ping	[Disabled]			
Dashboard	[None]			
Event Mask	[Group in blocks every 10 minutes]			
<b>Save</b>				

- After the device is re-discovered, it should now be aligned with the new device class.

## Creating a New Device Class for Devices That Do Not Support SNMP

SL1 includes device classes for devices that are "pingable". By default, these devices are aligned with the device category of "pingable" and are placed in the device class "Ping | ICMP". To discover devices that have a device category of "pingable", you must select **Discover Non-SNMP** in the **Discovery Session Editor** page.

Devices with the device category of "pingable" are devices that meet one of the following criteria:

- Device does not support SNMP.
- SNMP has been disabled on the device.
- Either no SNMP credential was provided in the discovery session or an incorrect SNMP credential was provided in the discovery session.

In some cases, you might want to discover a "pingable" device and use XML requests, XSLT requests, WMI requests, SOAP transactions, Python snippets, or SQL queries to gather information from the device. You can do this through Dynamic Applications.

You might also want to create a more descriptive device class for these types of devices and assign a device category other than "pingable". SL1 can use the values returned by nmap (run during discovery) to match a "pingable" device to a descriptive device class.

**NOTE:** You can use an existing device class as a template when defining a new device class. To do this, follow the steps in the [Editing a Device Class That is Not SNMP-Enabled](#) section, but supply a new name in the **Device Class** field and click **[Save As]** to save your changes.

**NOTE:** The **Device Class Tier** is a read-only field that is automatically populated by the subscription billing process. If you create a custom device class, please contact ScienceLogic Customer Support to define the **Device Class Tier** for the new device class.

When you create a new device class of type **Pingable**, you are defining a device class that uses the **XML values returned by nmap** to identify member devices.

To create a new device class with a device category of "pingable":

1. To discover details about devices that do not support SNMP, during discovery (System > Manage > Classic Discovery), you should select an **Initial Scan Level** of 5. *Deep Discovery* and select the checkbox for **Discover Non-SNMP**. SL1 will run the following nmap command on each device during discovery:

```
nmap -sS -O --host-timeout=12000ms "-p 21,22,23,25,80" -A --version-all -oX full pathname of file in which to store XML outputIP address of device
```

**NOTE:** Depending on your selections in the **Discovery Session Editor** page, SL1 might use the **-sU** or **-sT** option instead of **-sS**. The value supplied to the **host-timeout** option will vary depending upon the list of ports specified in the **Discovery Session Editor** page. The list of ports supplied with the **-p** option will vary depending upon the list of ports specified in the **Discovery Session Editor** page. For more details on the nmap command, see the webpage <http://nmap.org/book/man.html>.

2. SL1 stores the output from the nmap command in an XML file. In the **NMAP Report XPATH** field (described later in this section), you specify a path in that XML file. That path will specify the location of a value in the XML file. SL1 will then examine the specified value and use the regular expression defined in the **XPATH Match Regex** field (described later in this section) to match devices to this device class.
3. To begin gathering information to include in the device class, find a device for which you want to create a "pingable" device class. If you have already discovered this device, it might currently have a device class of "Ping | ICMP".

4. You must now run nmap on the device. You can either log in directly to the device or log in to another device that can communicate with the device on which you want to run nmap. At the command prompt, enter the following:

```
nmap -sS -O -oX full pathname of file in which to XML output -sV --version-all -A IP address of device
```

5. Navigate to the XML file where you stored the output from the nmap command. Examine the output and find an XML element or attribute that you can use to uniquely identify a device class for the device. Note the XPATH to the element or attribute.

**NOTE:** For information on XPATH syntax, see [http://www.w3schools.com/xpath/xpath\\_syntax.asp](http://www.w3schools.com/xpath/xpath_syntax.asp)

6. The device data in the XML report generally uses the following element structure:
  - Information about nmap, including scan level and debugging level.
  - Information about each discovered host, including start-time and end-time for the nmap and the IP address, MAC address, and hardware vendor.
  - Specific information about each port, including the service running on the port, some stored as attributes of the Port element, some stored as child elements of the Port element
  - Specific information about the operating system, include vendor and version number, stored as attributes of the OSClass element
  - Information about uptime for the device.
  - Information about traceroute to the discovered device and round-trip time to the discovered device.
  - Performance data for this session of nmap.
7. For example, suppose we want to create a device class for each device that runs an Apache web server. After running nmap on a device that is running Apache, we might see the following elements and attributes under **Host/Ports**:

```
<port protocol="tcp" portid="80">  
  <state state="open" reason="syn-ack" reason_ttl="64"/>  
  <service name="http" product="Apache httpd" version-"2.2.3", extranfo="(CentOS)"  
    method="probed" conf="10" />  
  <script id="html-title" output="Apache HTTP Server Test Page powered by CentOS" />  
  <script id="http-favicon" output="" />  
</port>
```

The XPATH would be `/nmaprun/host/ports/port/service/@product`

- Go to the **Device Class Editor** page (System > Customize > Device Classes) to create a new device class. Click the **[Reset]** button to clear any values from the **Device Class Editor** page. Supply a value in the following fields:

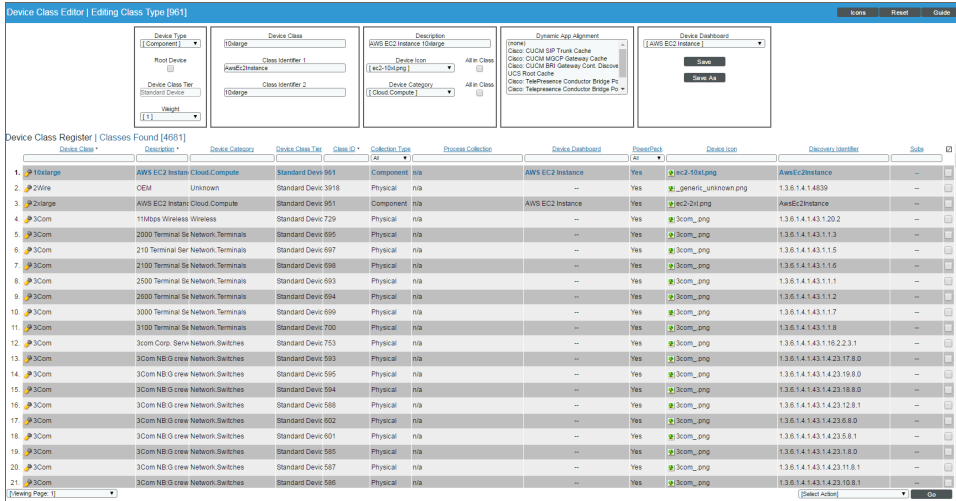

- Device Type.** Select *Pingable*.
- Root Device.** Specifies that this device can have children devices. Ensures that root devices are included in nightly re-discovery. Leave this box unchecked.
- Weight.** If two device-class definitions are similar, a device might meet the criteria for both device classes. In this case, the **Weight** field tells SL1 which device class to align with the device. The **Weight** field allows you to define both detailed, non-SNMP device-class definitions, as well as less detailed, catch-all device classes.

SL1 will align the device with the device-class definition with the lowest weight. If a device matches two device-class definitions, and both device classes have the same weight, SL1 will align the device with the device class that appears first in the alphabetical list of device classes.

For example, you could define a detailed device class with a weight of "1" and a similar but less detailed device class with a weight of "10". SL1 will first try to assign a discovered device to the device class with a weight of "1". If the device does not meet the criteria for that device class, SL1 will then try to assign the discovered device to the device class with a weight of "10".

- Device Class.** The name of the manufacturer who created the device and/or agent. Can be any combination of alphanumeric characters, up to 48 characters in length.

- **NMAP Report XPATH**. Specifies how should parse the results of an nmap request (run during discovery) to determine whether the device should be aligned to this device class. If you select an **Initial Scan Level** of 5. *Deep Discovery* for a discovery session, SL1 will run the following nmap command on each device during discovery. SL1 will include the -A option, to retrieve as much information as possible and match pingable devices with custom device classes.
  - In the **NMAP Report Path** field, enter the XPATH for the element or attribute you want to use to identify member devices. That path will specify the location of a value in the XML file. SL1 will then examine the specified value and use the regular expression defined in the **XPATH Match Regex** field to match devices to this device class.

In SL1 , the XPATH must always begin with **/nmaprun/host**. Using our example from step #7 above, we would provide an XPATH of:

**/nmaprun/host/ports/port/service/@product**

**NOTE:** In the **NMAP Report Path** field, we included the entire path to the attribute we want to match, **but intentionally did not filter on the attribute value**. That is, we specified **/nmaprun/host/ports/port/service/@product** instead of **/nmaprun/host/ports/port/service/@product='Apache httpd'**. When you include the value of the attribute in the XPATH, XPATH does not return the attribute value, but instead returns the entire element that includes the attribute. **Because the element is not a text string , SL1 cannot search the element using a regex.**

- **XPATH Match Regex**. In this field, specify a regular expression you want to use when examining the value returned by nmap. The location of the value returned by nmap is defined in the **NMAP Report XPATH** field. SL1 will align a device to a device class if the nmap response includes a value at the path specified in the **NMAP Report XPATH** and the value at that location matches the regular expression in the **XPATH Match Regex** field.

Using our example in step #7, we would provide the value **Apache httpd**.

- **Description**. The model name of the device. Can be any combination of alpha-numeric characters, up to 48-characters in length. For ease-of-use, ScienceLogic recommends that you follow this convention: If you are creating a device class for an entire manufacturer, rather than for a specific product, enter "OEM" as the device description.
- **Device Icon**. The icon used to display the device in the graphical interface. To view the available icons, click **[Icons]**. Select an icon from the drop-down list.
- **All in class**. Selecting this checkbox updates the device icon for all existing members of the device class.
- **Device Category**. A logical categorization of device by primary function. This field allows to group related devices in reports and views. Select a value from drop-down list.
- **All in class**. Selecting this checkbox updates the device category for all existing members of the device class.

- **Collection Type.** Specifies whether the device is a hardware-based device (physical) or a virtual device.
- **Weight.** If two device-class definitions are very similar, a device might meet the criteria for both device classes. In this case, the **Weight** field tells which device class to align with the device. SL1 will align the device with the device-class definition with the lowest weight. If a device matches two device-class definitions, and both device classes have the same weight, SL1 will align the device with the device-class that appears first in the alphabetical list of device classes.

The **Weight** field allows you to define detailed non-SNMP device-class definitions and still have catch-all device-classes with less-specific criteria.

For example, you could define a detailed device class with a weight of "1" and a similar but less detailed catch-all device class with a weight of "10". SL1 will first try to assign a discovered device to the device class with a weight of "1". If the device does not meet the criteria for that device class, SL1 will then try to assign the discovered device to the device class with a weight of "10".

- **Device Dashboard.** Select a device dashboard from a list of all device dashboards in SL1. For devices with this device class, the selected device dashboard will appear as an option in the **Device Class Editor** page. This field is optional.

9. Click the **[Save]** button to save your changes to the device class or click the **[Save As]** button to save your changes under a new device-class name.

## Applying the New Device Class

To apply a new "pingable" device class during discovery:

1. Go to the **Discovery Control Panel** page (System > Manage > Classic Discovery). If you are creating a new discovery session, click the **[Create]** button. If you are editing an existing discovery session, click its wrench icon ().
2. In the **Discovery Session Editor** page:
  - In the **Initial Discovery Scan Level** field, select 5. *Deep Discovery*.

**NOTE:** You can also define **Initial Discovery Scan Level** in the **Behavior Settings** page (System > Settings > Behavior). Because this discovery level is very compute-intensive, you might want to avoid setting this discovery level globally and instead choose this discovery level **only for specific discovery sessions**.

- Select the **Discover Non-SNMP** checkbox.
  - Select the **Model Device** checkbox.
3. Click the **[Save]** button.
  4. When you run the discovery session, SL1 will apply the new device class to discovered or re-discovered devices.



**NOTE:** You can also apply a new "pingable" device class *during nightly auto-discovery*. You can define (nightly) **Rediscovery Scan Level** in the **Behavior Settings** page (System > Settings > Behavior) and select *5. Deep Discovery*. **However, because this auto-discovery level is very compute-intensive, you might not want to use this setting for global auto-discovery.**

## Maintaining the New Device Class During Auto-Discovery

If you have applied a new "pingable" device class to a device, you should do the following to make sure that doesn't reset the device's device-class to "Ping | ICMP" during nightly auto-discovery.

**NOTE:** SL1 will reset a pingable device's device class to "Ping | ICMP" if Deep Discovery is not enabled for nightly auto-discovery. You can enable Deep Discovery for nightly auto-discovery in the **Behavior Settings** page (System > Settings > Behavior). Go to the field **Rediscovery Scan Level**, and select *5. Deep Discovery*. However, because this auto-discovery level is very compute-intensive, you might not want to use this setting for global auto-discovery.

You can disable auto-discovery for each device that uses Deep Discovery. Instead of using nightly auto-discovery, you can create a scheduled discovery session that will update the device class. To do this:

1. Go to the **Device Properties** page (Devices > Device Manager > wrench icon).
2. Unselect the checkbox for **Auto-Update**.
3. Click the **[Save]** button.
4. Go to the **Discovery Control Panel** page (System > Manage > Classic Discovery) and create a discovery session for this device (and each device that uses Deep Discovery and which you want to update regularly). When creating this discovery session:
  - In the **Initial Discovery Scan Level** field, select *5. Deep Discovery*.
  - Select the **Discover Non-SNMP** checkbox.
  - Select the **Model Device** checkbox.
5. Define the new discovery session as a scheduled discovery session, so you can periodically update the device's data.



## Editing a Device Class That is Not SNMP-Enabled

In the **Device Class Editor** page, you can edit the parameters of an existing device class.

When you **do not select SNMP Enabled**, you are defining a device class that does not use SNMP to identify member devices. Instead, the device class will use a value returned by nmap (run during discovery) to identify member devices.

**NOTE:** You can use an existing device class as a template for a new device class. To do this, follow the steps in this section, but supply a new name in the **Device Class** field and select the **[Save As]** button to save your changes.

To edit an existing Device Class:

1. Go to the **Device Class Editor** page (System > Customize > Device Classes), or from the **Device Properties** page, select the pencil icon ()
2. In the **Device Class Register** pane at the bottom of the page, find the device class you want to edit. Select its wrench icon ()
3. The fields in the top pane will be populated with values from the selected device class.
4. In the **Device Class Editor** page, you can edit the parameters of an existing device class. If you do not select **SNMP Enabled** in the **Device Type** drop-down list, you can edit the value in one or more of the fields described in the section [Creating a New Device Class for Devices That Do Not Support SNMP](#).
5. Select the **[Save]** button to save your changes to the device class or select the **[Save As]** button to save your changes under a new
6. The newly selected device class is now associated with the device.

## Creating a New Component Device Class

A device of type "component" is an entity that runs under the control of a management system running on a physical device. For example, SL1 can discover a VMware ESX Server (management system) and then discover the virtual machines (component devices) running on that VMware ESX Server.

SL1 uses Dynamic Applications to retrieve data from a management system and discover each component device managed by that system. SL1 then uses that retrieved data to create a device record for each component device.

Device classes for components are aligned with the Dynamic Applications that discover component devices. For example, we could have a device class of type **Component** for "Cisco Systems | UCS Chassis". We could align the Dynamic Application for "UCS Chassis Discovery" with this device class. When SL1 runs the "UCS Chassis Discovery" Dynamic Application and discovers a component device, SL1 assigns each discovered component device to the device class "Cisco Systems | UCS Chassis".

When you create a new device class of type **Component**, you are defining a device class that uses an aligned Dynamic Application to identify the member devices.

**NOTE:** The **Device Class Tier** is a read-only field that is automatically populated by the subscription billing process. If you create a custom device class, please contact ScienceLogic Customer Support to define the **Device Class Tier** for the new device class.

To create a new device class of type **Component**:



1. Go to the Device Class editor page (System > Customize > Device Classes).
2. Click **[Reset]** to clear the fields in the **Device Class Editor** pane.
3. Configure the device class as follows:
  - **Device Type.** Select "Component".
  - **Device Class.** Enter "ScienceLogic".
  - **Device Category.** Select "Servers" from the drop-down list. This field specifies a logical categorization of devices by primary function, which allows SL1 to group related devices in reports and views.
  - **Root Device.** Select this checkbox if you will have additional tiers under this component device.
  - **Description.** Enter a description for the device. Our example uses "SL1 Appliance".
  - **Device Icon.** Select an icon that you created or select a generic icon.
4. Click **[Save]** to save your changes to the device class. Our completed example is shown below.

The screenshot shows the 'Device Class Editor' interface with the following configuration:

- Device Type:** Component
- Root Device:** Checked
- Device Class:** ScienceLogic
- Description:** SL1 Appliance
- Device Icon:** SL1Root4.png
- Device Category:** Servers
- Dynamic App Alignment:** (none)
- Device Dashboard:** [None]

## Editing a Component Device Class

To edit an existing Device Class of Type "Component":

1. Go to System > Customize > Device Classes, or from the **Device Properties** page, select the pencil icon (  ).
2. In the **Device Class Register** pane at the bottom of the page, find the device class you want to edit. Select its wrench icon (  ).
3. The fields in the top pane will be populated with values from the selected device class.
4. You can edit the value in one or more of the fields. For details on each field, see the section on [Creating a New Device Class of Type "Component"](#).
5. Select the **[Save]** button to save your changes to the device class or select the **[Save As]** button to save your changes under a new device-class name.

## Managing Device Classes

The following sections describe how to manually assign a device class to a device and how to change the icon for a device class in SL1.

## Manually Assigning a Device Class to a Device

To manually assign a device class to a device:

1. Go to the **Devices** page and select the device to which you want to assign a device class.
2. On the **Device Investigator** page, click **[Edit]**.
3. Click the **Info** drop-down and click the **Device Class** field. The **Select a Device Class** window appears:

 DEVICE CLASS	DEVICE CATEGORY	TYPE
<input type="radio"/> Digi International OEM	Unknown	physical
<input type="radio"/> Cisco Systems Nexus Fabrics Container	Network.Modules	component
<input type="radio"/> Linux Red Hat Enterprise	Servers	physical
<input type="radio"/> Cisco Systems UC 520M-48U-6BRIW	Telephony	physical
<input type="radio"/> Cisco Systems ASA 5545-K7	Network.Firewall	physical
<input type="radio"/> Cisco Systems CE 7341	Servers	physical
<input type="radio"/> Cisco Systems ESR 5940RA	Network.Router	physical
<input type="radio"/> NetScout Systems Probe3220	Network.Probes	physical

4. The **Select a Device Class** window displays a searchable list of available device classes, and the category and type for each class. Select the device class you want to assign, then click the **[Set Class]** button.
5. Click the **[Save]** button on the **Device Investigator** page to save your changes.

## Changing the Icon for a Device Class

You can customize the look and feel of the devices that appear on the **Devices** page by assigning an icon a device, device class, or device category.

To assign an icon to a device, device class, or device category:

1. On the **Devices** page, **Device Classes** page (Devices > Device Classes), or **Device Categories** page (Devices > Device Categories), locate the device, class, or category for which you want to add an icon.
2. Click the **Actions** button (☰) for that item and select *Assign Icon*. The **Select an Icon** window appears:

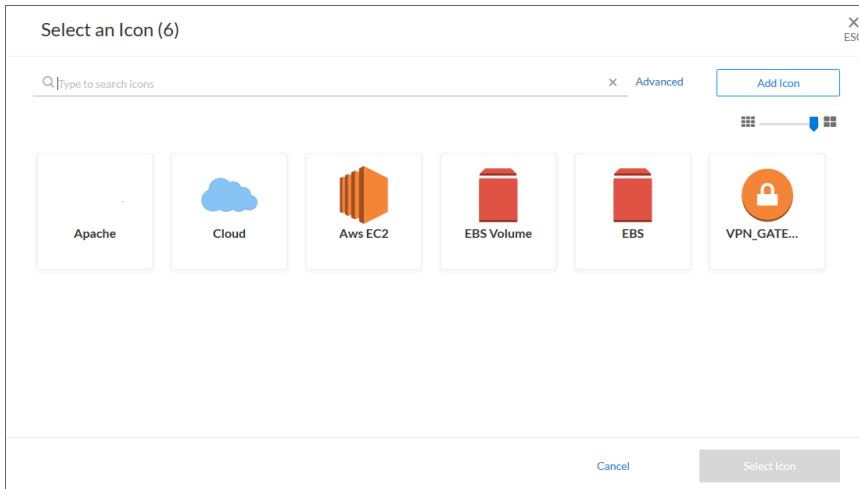

**TIP:** To assign an icon to more than one device, device class, or device category, select the checkboxes to the left of those items and click **Assign Icon** in the blue bar at the bottom of the screen.

3. To use an existing icon, select that icon from the list of icons and click the **[Select Icon]** button.

**TIP:** If an icon includes a tag, you can search for that icon by typing some or all of the tag text in the **Search** field.

4. To upload an icon from your local drive, make sure that the image file meets the following criteria:
  - The image file should be in .SVG format.
  - The file should not be larger than 40 KB.
  - The file should not be animated.
  - The file should not contain bitmaps.

- To start the upload process, click the **[Add Icon]** button. The **Add an Icon** window appears:

The screenshot shows a dialog box titled "Add an Icon" with a close button (X ESC) in the top right corner. The dialog contains the following elements:

- An "Icon name" input field.
- An "ADD TAGS" section with a "#" icon and a "New tag" input field.
- A "Browse or Drop" area with a dashed border.
- A "REUSE TAGS" section.
- A list of requirements for icons:
  - Icons must:
  - Be SVG format
  - Be no more than 40kb
  - Not be animated
  - Not contain bitmaps
- At the bottom, there are "Cancel" and "Add Icon" buttons.

- In the **Icon name** field, type a name for the icon you want to upload.
- In the **Add Tags** field, type a short descriptor for the icon, without spaces. You can use this tag for searching later.
- You can click the **Browse or Drop** area to browse for and select the icon, or you can drag and drop the icon file onto the **Add an Icon** window.
- Click the **[Add Icon]** button. The icon is added to the **Select an Icon** window.
- Click the **[Select Icon]** button to add the icon to the selected item.

---

## Managing Device Classes in the Classic SL1 User Interface

The following sections describe:

- [Manually changing the device class for a device](#)
- [Changing the icon for a device class](#)
- [Deleting one or more device classes](#)

### Manually Changing the Device Class for a Device in the Classic SL1 User Interface

During discovery, SL1 automatically assigns a device class to each discovered device. For example, SL1 assigns the device class "Ping" to devices that do not support SNMP. You might want to manually change the device class for such a device after discovery.

In the **Device Properties** page, you can assign a different device class to the device.

To assign a different device class to the device:

1. Go to the **Device Manager** page (Devices > Device Manager).
2. Find the device you want to edit. Select its wrench icon ()

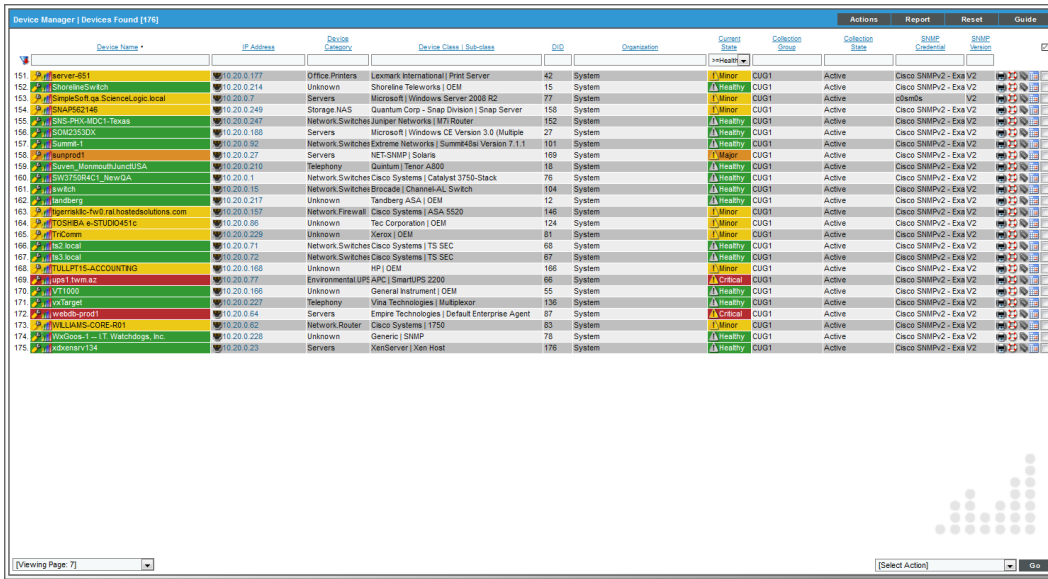

Device Name	IP Address	Device Class	Sub-class	DID	Organization	Health Status	Collection Group	Collection Rate	SNMP General	SNMP Instance
xkxserver-851	10.20.0.177	Office Printers	Lexmark International   Print Server	42	System	Minor	CUG1	Active	Cisco SNMPv2 - Exa V2	
chobensSwitch	10.20.0.214	Unknown	Shoreline Teleworks   OEM	15	System	Healthy	CUG1	Active	Cisco SNMPv2 - Exa V2	
em7cu2	10.20.0.175	Servers	Microsoft   Windows Server 2008 R2	77	System	Minor	CUG1	Active	ipMI	
xkxserver134	10.20.0.249	Storage NAS	Quantum Corp - Snap Division   Snap Server	158	System	Minor	CUG1	Active	Cisco SNMPv2 - Exa V2	

3. In the **Device Properties** page, find the **Device Class** field. Select the toolbox icon ()

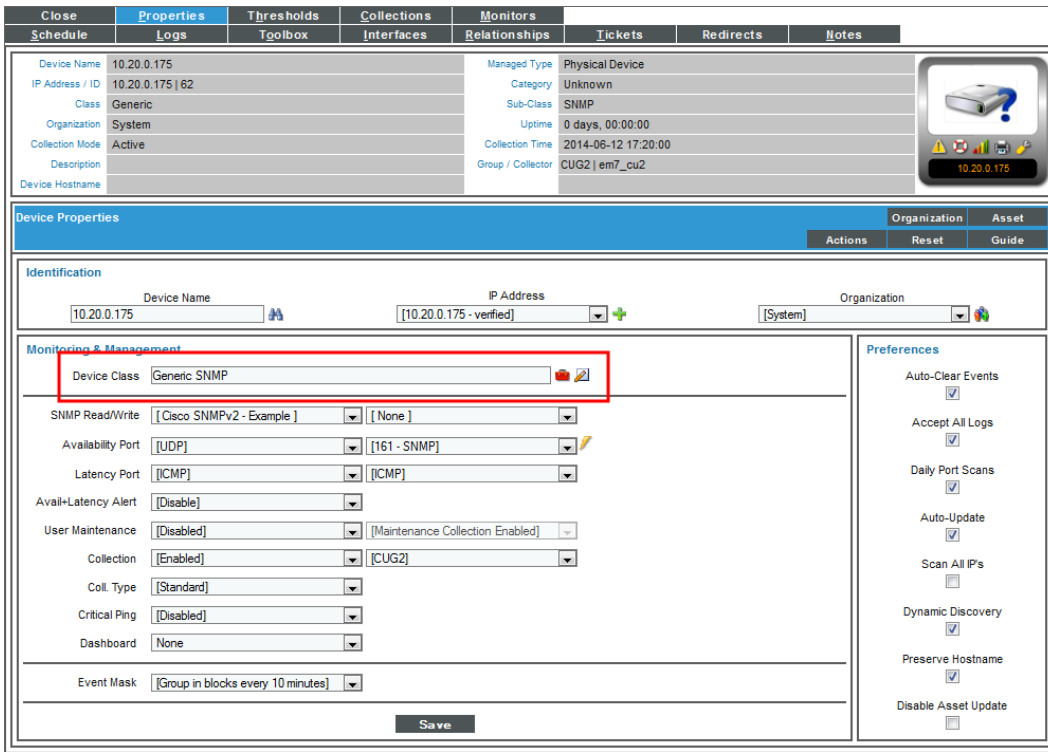

Close	Properties	Thresholds	Collections	Monitors	Tickets	Redirects	Notes
Schedule	Logs	Toolbox	Interfaces	Relationships			

Device Name: 10.20.0.175  
 IP Address / ID: 10.20.0.175 | 62  
 Class: Generic  
 Organization: System  
 Collection Mode: Active  
 Description: [Empty]  
 Device Hostname: [Empty]

Managed Type: Physical Device  
 Category: Unknown  
 Sub-Class: SNMP  
 Uptime: 0 days, 00:00:00  
 Collection Time: 2014-06-12 17:20:00  
 Group / Collector: CUG2 | em7\_cu2

**Device Properties** Organization: [System] Asset: [Empty]

Actions: [Reset] [Guide]

**Identification**

Device Name: [10.20.0.175] IP Address: [10.20.0.175 - verified] Organization: [System]

**Monitoring & Management**

Device Class: Generic SNMP 

SNMP Read/Write: [Cisco SNMPv2 - Example] [None]

Availability Port: [UDP] [161 - SNMP]

Latency Port: [ICMP] [ICMP]

Avail-Latency Alert: [Disable]

User Maintenance: [Disable] [Maintenance Collection Enabled]

Collection: [Enabled] [CUG2]

Coll. Type: [Standard]

Critical Ping: [Disable]

Dashboard: [None]

Event Mask: [Group in blocks every 10 minutes]

Save

**Preferences**

Auto-Clear Events

Accept All Logs

Daily Port Scans

Auto-Update

Scan All IP's

Dynamic Discovery

Preserve Hostname

Disable Asset Update

4. In the **Select New Device Class** modal page, select a device class.

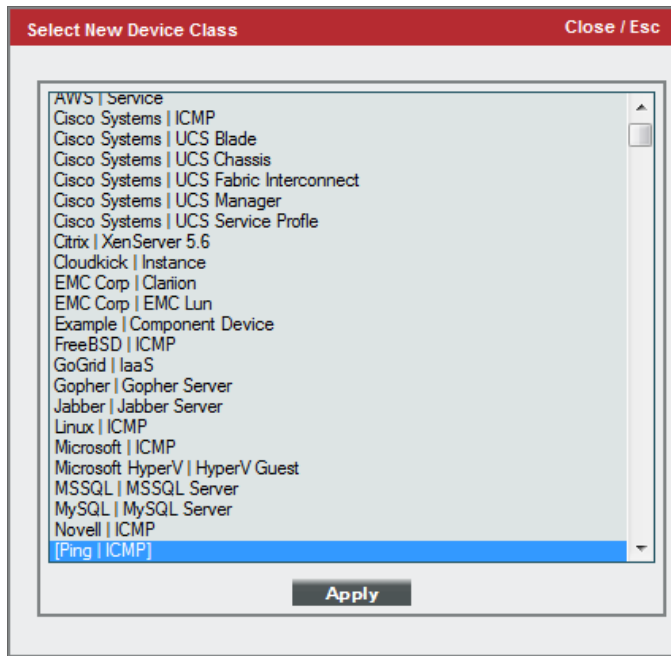

5. There are two other ways to align devices with the devices class:

- You can re-run discovery for a single device. To re-discover a device, go to **Devices > Device Manager**. Find the device you want to re-discover. Select its wrench icon (🔧). In the **Device Properties** page for the device, select the binoculars icon (🔍). After the device is re-discovered, it will be aligned with the appropriate device class. You can repeat this process for each device you want to align with the new or edited device class.
- If you re-run one or more discovery sessions (**System > Manage > Classic Discovery**), SL1 will automatically apply the new or edited device class to those devices that match the criteria. Remember that to discover details about device of type "pingable", you must select the checkbox **Discovery Non-SNMP**. Optionally, to retrieve details about "pingable" devices, in the field **Initial Scan Level**, you can also select *5. Deep Discovery*.

## Changing the Icon for a Device Class in the Classic SL1 User Interface

You can select a new icon for a device class or import your own image as an icon. To do this:

1. Go to the **Device Class Editor** page (**System > Customize > Device Classes**), or from the **Device Properties** page, select the pencil icon (✎).
2. In the **Device Class Register** pane at the bottom of the page, find the device class you want to edit. Select its wrench icon (🔧).



3. The fields in the top pane will be populated with values from the selected device class. To edit the icon associated with the selected device class, edit the value of the **Device Icon** field. The icon you select will be associated with the device class.
  - To view the list of icon names and icon images, select the **[Icon]** button in the upper right of the page.
  - The **Device Icon Browser** modal page displays a list of all icons for device class.
  - To import an image to use as an icon, select the **[Import]** button. In the **Device Icon Browser** modal page, you can import a .png image for use as an icon in SL1.
4. Select the **[Save]** button to save the changes to the device class.

## Aligning One or More Device Classes with a Device Dashboard

From the **Device Class Editor** page, you can align one or more device classes with a device dashboard. You can manually align a device dashboard with a device class. For devices that do not have a device dashboard defined in the **Device Properties** page, the device dashboard associated with the device class will appear as the default view in the **Device Summary** page.

**NOTE:** From the **Device Summary** page, the user can select and view any device dashboards that are associated with the device, the device's device class, the device's device category, the device's Dynamic Applications, and the Global Default.

1. To align a device dashboard with one or more device classes:
2. Go to the **Device Class Editor** page (System > Customize > Device Classes).
3. In the **Device Class Register** pane at the bottom of the page, find the device class(es) you want to align. Select its checkbox .
4. In the **Select Action** drop-down in the lower right, select a device dashboard in the *Align Device Dashboard* section. Select the **[Go]** button.
5. Each selected device class is now aligned with the selected device dashboard. For devices that do not have a device dashboard defined in the **Device Properties** page, the device dashboard associated with the device class will appear as the default view in the **Device Summary** page.

## Deleting One or More Device Classes

From the **Device Class Editor** page, you can delete one or more device classes.

**NOTE:** Before you delete a device class, you should assign any member devices to another device class. If you delete a device class that is associated with a device, that device will now display "Unknown - Missing" for device class. During the next discovery session, SL1 will try to find the appropriate device class for the device.

To delete one or more device classes:

1. Go to the **Device Class Editor** page (System > Customize > Device Classes), or from the **Device Properties** page, select the pencil icon () .
2. In the **Device Class Register** pane at the bottom of the page, find the device class(es) you want to delete. Select its checkbox.
3. In the **Select Action** drop-down in the lower right, select *DELETE Device Classes*. Select the **[Go]** button.
4. Each selected device class is deleted from SL1 .
5. If the device class includes devices, after deletion, those devices will have a device class of "unknown". While the device has a device class of "unknown", polling associated with existing device policies might fail. During the next discovery session, SL1 will rediscover those devices and try to assign a device class to another device class. For example, if you delete the device class for Microsoft Servers, during nightly discovery, SL1 would assign those devices to the device class for Microsoft OEM.

---

## Device Categories

A **device category** is a logical categorization of a device by primary function, such as "server", "switch", or "router". SL1 uses device categories to group related devices in reports and views.

Device categories are paired with device classes to organize and describe discovered devices. Device class usually describes the manufacturer. Device category describes the function of the hardware. Each device class can include a device category.

**NOTE:** "Reserved" device categories are those device categories required by SL1 . These device categories cannot be edited or deleted. If a device category does not display the bomb icon (), the device category is a reserved device category and cannot be deleted.

### "Pingable" Device Category

Devices that have a device category of "pingable" are devices that meet one of the following:

- Device does not support SNMP.
- SNMP has been disabled on the device.
- Wrong credential was provided during discovery and "Discover Non-SNMP" was enabled for the discovery session.

## Viewing the List of Device Categories

On the **Device Categories** page (Devices > Device Categories), if you have the proper permissions, you can view a list of existing device categories, create and edit device categories, and duplicate device categories. You can also assign an icon to a specific device category, and those icons will appear on the **Device Categories** page. The icons also appear on Maps as well as Device Investigator, Service Investigator, and Application Investigator pages.

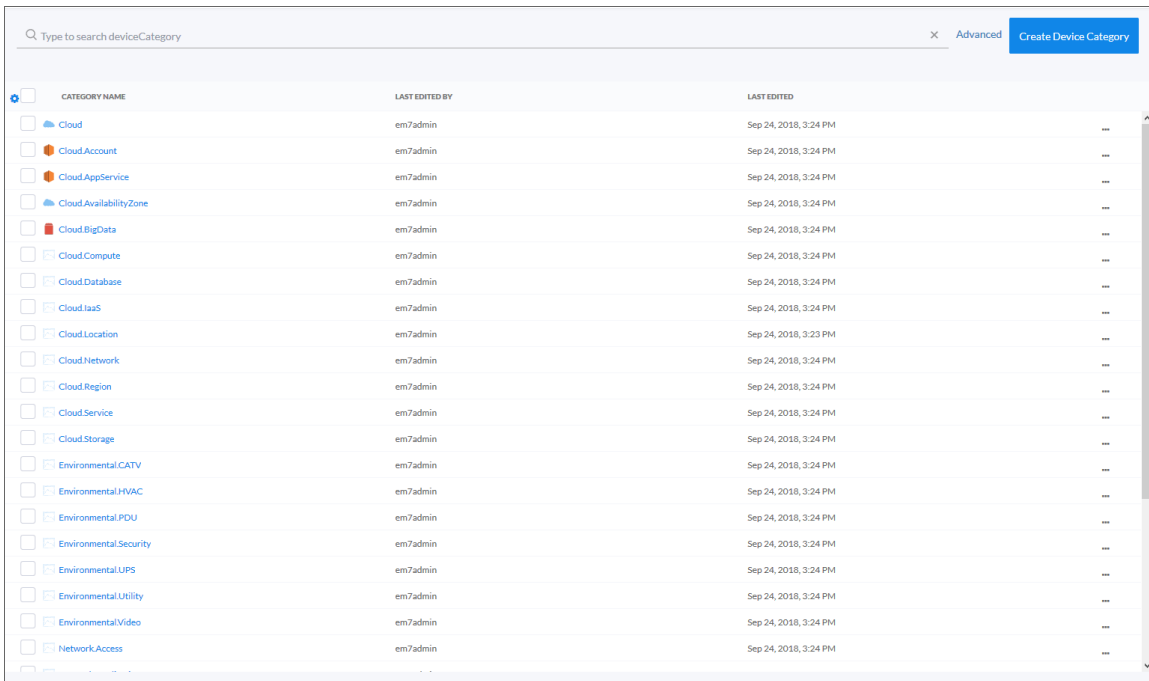

The screenshot shows a web interface for managing device categories. At the top, there is a search bar with the placeholder text "Type to search deviceCategory". To the right of the search bar are two buttons: "Advanced" and "Create Device Category". Below the search bar is a table with the following columns: "CATEGORY NAME", "LAST EDITED BY", and "LAST EDITED". The table contains 20 rows of device categories, each with a small icon to the left of the category name. The categories listed are: Cloud, Cloud.Account, Cloud.AppService, Cloud.AvailabilityZone, Cloud.BigData, Cloud.Compute, Cloud.Database, Cloud.IaaS, Cloud.Location, Cloud.Network, Cloud.Region, Cloud.Service, Cloud.Storage, Environmental.CATV, Environmental.HVAC, Environmental.PDU, Environmental.Security, Environmental.UPS, Environmental.Utility, Environmental.Video, and Network.Access. All "LAST EDITED BY" entries are "em7admin" and all "LAST EDITED" entries are "Sep 24, 2018, 3:24 PM".

CATEGORY NAME	LAST EDITED BY	LAST EDITED
Cloud	em7admin	Sep 24, 2018, 3:24 PM
Cloud.Account	em7admin	Sep 24, 2018, 3:24 PM
Cloud.AppService	em7admin	Sep 24, 2018, 3:24 PM
Cloud.AvailabilityZone	em7admin	Sep 24, 2018, 3:24 PM
Cloud.BigData	em7admin	Sep 24, 2018, 3:24 PM
Cloud.Compute	em7admin	Sep 24, 2018, 3:24 PM
Cloud.Database	em7admin	Sep 24, 2018, 3:24 PM
Cloud.IaaS	em7admin	Sep 24, 2018, 3:24 PM
Cloud.Location	em7admin	Sep 24, 2018, 3:23 PM
Cloud.Network	em7admin	Sep 24, 2018, 3:24 PM
Cloud.Region	em7admin	Sep 24, 2018, 3:24 PM
Cloud.Service	em7admin	Sep 24, 2018, 3:24 PM
Cloud.Storage	em7admin	Sep 24, 2018, 3:24 PM
Environmental.CATV	em7admin	Sep 24, 2018, 3:24 PM
Environmental.HVAC	em7admin	Sep 24, 2018, 3:24 PM
Environmental.PDU	em7admin	Sep 24, 2018, 3:24 PM
Environmental.Security	em7admin	Sep 24, 2018, 3:24 PM
Environmental.UPS	em7admin	Sep 24, 2018, 3:24 PM
Environmental.Utility	em7admin	Sep 24, 2018, 3:24 PM
Environmental.Video	em7admin	Sep 24, 2018, 3:24 PM
Network.Access	em7admin	Sep 24, 2018, 3:24 PM

For each device category, the **Device Categories** page displays the following information:

- **Category Name.** The name of the device category.
- **Last Edited By.** The name of the user who created or last edited the device category.
- **Last Edited.** The date and time at which the device category was created or last edited.

**TIP:** To rearrange the columns in the List View, click and drag the column name to a new location. You can adjust the width of a column with by clicking and dragging the right edge of the column. You can click the **Select Columns** icon (⚙️) to add or remove columns, or to reset columns to their default settings.

---

## Creating a New Device Category

To create a new device category:

1. On the **Device Categories** page (Devices > Device Categories), click the **[Create Device Category]** button. The **Add New Category** window appears:

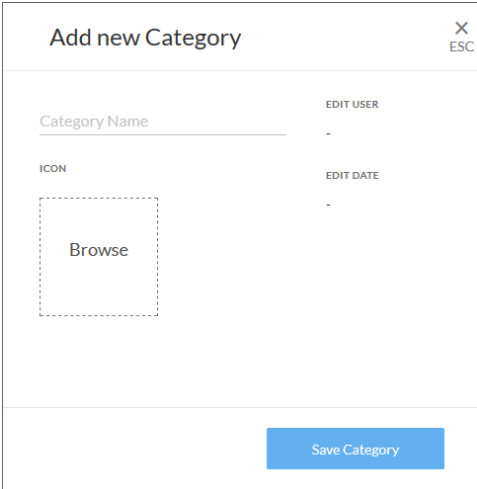

2. In the **Category Name** field, type a name for the new device category.
3. To add an icon for the new category, click the **Browse** area to select an existing icon from the **Select an Icon** window.

**TIP:** If an icon includes a tag, you can search for that icon by typing some or all of the tag text in the **Search** field.

4. On the **Add New Category** window, click the **[Save Category]** button. The category is added to the **Device Categories** page.

---

## Editing a Device Category

To edit a device category:

1. On the **Device Categories** page, locate the device category that you want to edit.
2. Click the name of the device category to open the category details page.
3. You can edit the **Category Name** and **Icon**. When you are finished making changes, click the **[Save Category]** button.

---

## Duplicating a Device Category

To duplicate a device category:

1. On the **Device Categories** page, locate the device category that you want to duplicate.
2. Click the **Actions** button (☰) for that device category and select *Duplicate*.
3. A duplicate of that device category will appear with the word "copy" appended to the original name. Click on the name of the device category to edit the category name.

---

## Assigning an Icon to a Device Category

You can customize the look and feel of the devices that appear on the **Devices** page by assigning an icon a device, device class, or device category.

To assign an icon to a device, device class, or device category:

1. On the **Devices** page, **Device Classes** page (Devices > Device Classes), or **Device Categories** page (Devices > Device Categories), locate the device, class, or category for which you want to add an icon.
2. Click the **Actions** button (☰) for that item and select *Assign Icon*. The **Select an Icon** window appears:

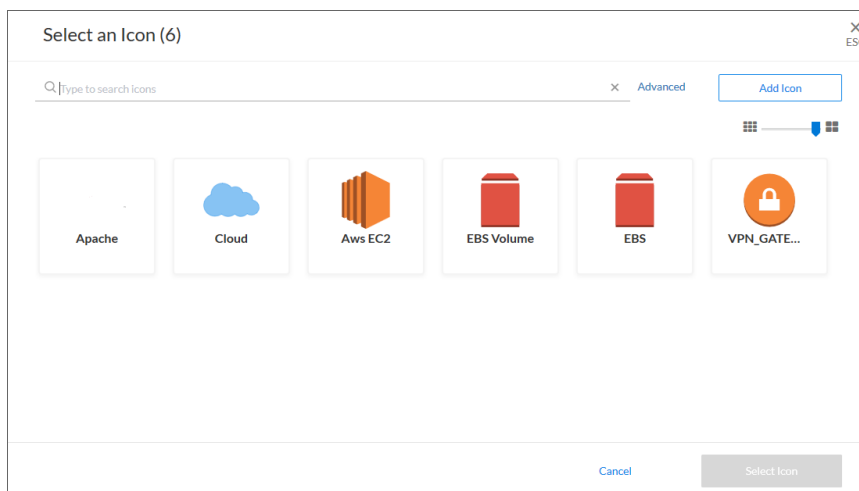

**TIP:** To assign an icon to more than one device, device class, or device category, select the checkboxes to the left of those items and click **Assign Icon** in the blue bar at the bottom of the screen.

3. To use an existing icon, select that icon from the list of icons and click the **[Select Icon]** button.

**TIP:** If an icon includes a tag, you can search for that icon by typing some or all of the tag text in the **Search** field.

4. To upload an icon from your local drive, make sure that the image file meets the following criteria:
  - The image file should be in .SVG format.
  - The file should not be larger than 40 KB.
  - The file should not be animated.
  - The file should not contain bitmaps.
5. To start the upload process, click the **[Add Icon]** button. The **Add an Icon** window appears:

The screenshot shows a dialog box titled "Add an Icon" with a close button (X ESC) in the top right corner. The dialog contains the following elements:

- An "Icon name" input field.
- An "ADD TAGS" section with a "# New tag" input field.
- A "Browse or Drop" area with a dashed box.
- A "REUSE TAGS" section.
- A list of requirements: "Icons must: Be SVG format, Be no more than 40kb, Not be animated, Not contain bitmaps".
- "Cancel" and "Add Icon" buttons at the bottom.

6. In the **Icon name** field, type a name for the icon you want to upload.
7. In the **Add Tags** field, type a short descriptor for the icon, without spaces. You can use this tag for searching later.
8. You can click the **Browse or Drop** area to browse for and select the icon, or you can drag and drop the icon file onto the **Add an Icon** window.
9. Click the **[Add Icon]** button. The icon is added to the **Select an Icon** window.
10. Click the **[Select Icon]** button to add the icon to the selected item.

---

## Managing Device Categories in the Classic SL1 User Interface

This section describes how to view, define, and manage device categories using the **Device Category Editor** in the classic SL1 user interface.

# Viewing the List of Device Categories in the Classic SL1 User Interface

The **Device Category Editor** page displays a list of all existing device categories. To view this page:

1. Log in to SL1.
2. Go to the **Device Category Editor** page (System > Customize > Device Categories).

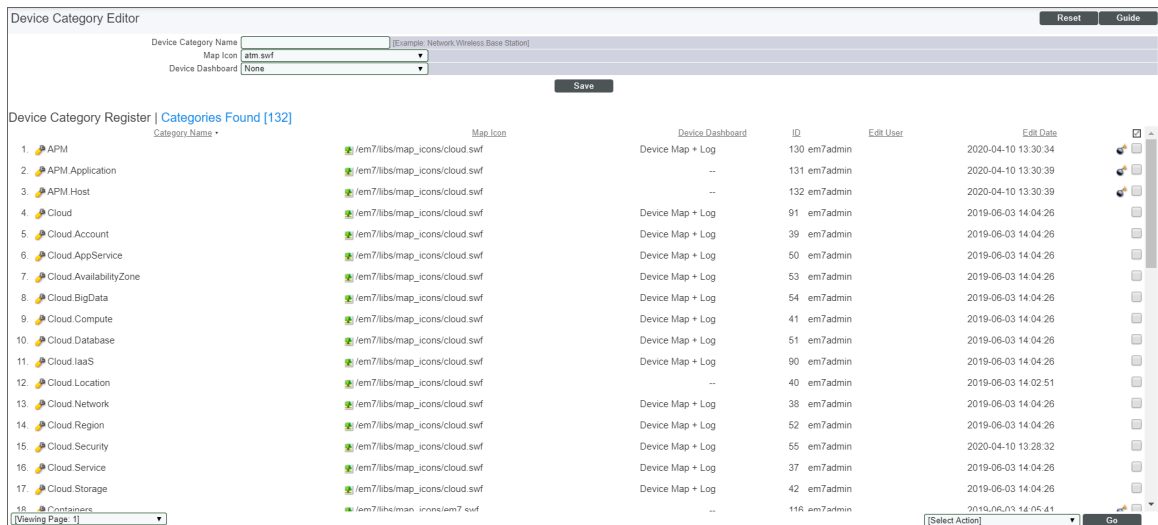

3. For each device category, the **Device Category Editor** page displays the following:
  - **Category Name**. The name of the device category.
  - **Map Icon**. Pathname of the image used as an icon for the device category.
  - **Device Dashboard**. This field displays the device dashboard associated with the device category.
  - **ID**. A unique numeric identifier for the device category, automatically assigned by SL1.
  - **Edit User**. User who created or last edited the device category.
  - **Edit Date**. Date and time the device category was created or last edited.

**TIP:** To sort the list of device categories, click on a column heading. The list will be sorted by the column value, in ascending order. To sort by descending order, click the column heading again. The **Edit Date** column sorts by descending order on the first click; to sort by ascending order, click the column heading again.

# Creating a New Device Category in the Classic SL1 User Interface

From the **Device Category Editor** page, you can create a new device category. To do this:

1. Go to the **Device Category Editor** page (System > Customize > Device Categories).

- Click the **[Reset]** button to clear any values from the fields in the editor pane.

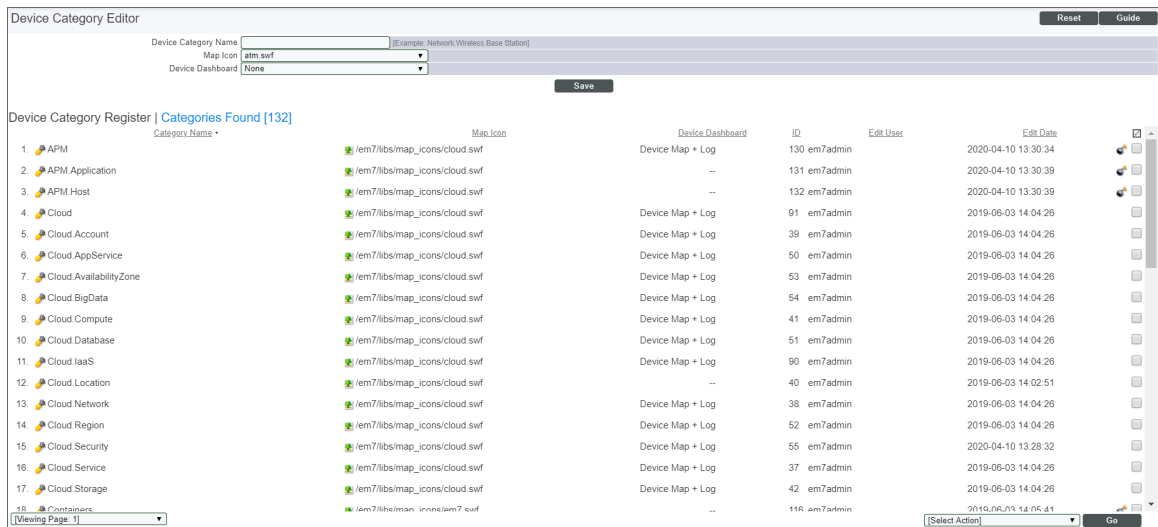

- In the editor pane at the top of the page, supply values in each of the following fields:

- Category Name.** Enter a name for the new device category. This name can be any combination of alphanumeric characters, up to 32 characters in length. SL1 naming convention is to create names using the following prefixes:
  - Environmental* for environmental-monitoring devices.
  - Network* for networking hardware like routers, switches, and firewalls.
  - Office* for office equipment.
  - Server* for server hardware.
  - System* for networked hardware like servers and network stores.
  - Telephony* for telephone hardware.
  - Wireless* for wireless network hardware.

However, you are not required to follow this convention.

- Map Icon.** Select an icon to be associated with this device category. You can select from a list of all possible icons for device categories. The selected icon will be used to represent members of the device category in the network maps in Views and maps.
- Device Dashboard.** Select a device dashboard from a list of all device dashboards in SL1. For devices with this device category, the selected device dashboard will appear as an option in the **Device Summary** page. This field is optional.

- Click the **[Save]** button.
- The new device category should now appear in the list of device categories in this page and appear in the **Device Category** drop-down list in the **Device Class Editor** page.



## Editing a Device Category in the Classic SL1 User Interface

In the **Device Category Editor** page, you can edit the parameters of an existing device category. To do this:

1. Go to the **Device Category Editor** page (System > Customize > Device Categories).
2. In the register pane at the bottom of the page, find the device category you want to edit. Click its wrench icon ().

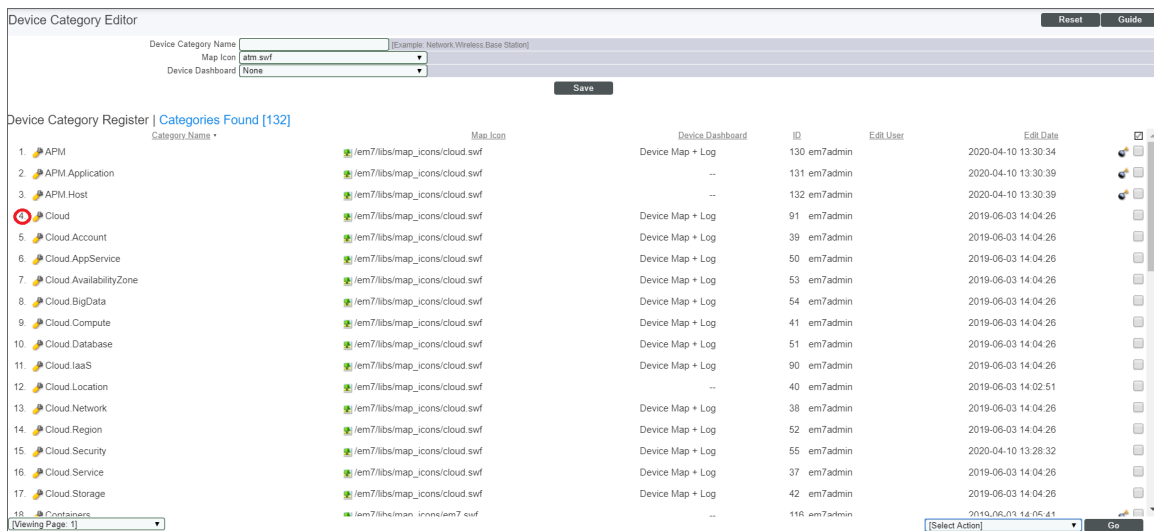

3. The fields in the top pane will be populated with values from the selected device category. You can edit the value in one or more of the fields.
4. For a description of each field, see the previous section on [Creating a New Device Category](#).

## Deleting a Device Category

From the **Device Category Editor** page, you can delete an existing device category.

**CAUTION:** Do not delete device categories that are being used by managed devices. If you delete a device category to which devices have been assigned, you risk losing data from the device.

To delete a device category:

1. Go to the **Device Category Editor** page (System > Customize > Device Categories).
2. Find the device category you want to delete. Click its bomb icon (.
3. The device category is deleted from SL1.

## Aligning One or More Device Categories with a Device Dashboard

From the **Device Category Editor** page, you can align one or more device categories with a device dashboard. For devices that do not have a device dashboard defined in the **Device Properties** page or in the **Device Class Editor** page, the device dashboard associated with the device category will appear as the default view in the **Device Summary** page.

**NOTE:** From the **Device Summary** page, the user can select and view any device dashboards that are associated with the device, the device's device class, the device's device category, the device's Dynamic Applications, and the Global Default.

To align a device dashboard with one or more device categories:

1. Go to the **Device Category Editor** page (System > Customize > Device Categories).
2. Find the device categories you want to align. Select their checkboxes .
3. In the **Select Action** drop-down list in the lower right, select a device dashboard under the *Align Device Dashboard* section. Click the **[Go]** button.
4. Each selected device category is now aligned with the selected device dashboard. For devices that do not have a device dashboard defined in the **Device Properties** page or in the **Device Class Editor** page, the device dashboard associated with the device category will appear as the default view in the **Device Summary** page.

---

# Chapter

# 8



## Device Relationships

---

### Overview

This chapter describes device relationships in SL1.

Use the following menu options to navigate the SL1 user interface:

- To view a pop-out list of menu options, click the menu icon ()
- To view a page containing all of the menu options, click the Advanced menu icon ().

This chapter includes the following topics:

<b><i>What are Device Relationships?</i></b> .....	<b>180</b>
<b><i>Viewing the List of Device Relationships</i></b> .....	<b>181</b>
<i>Filtering the List of Device Relationships</i> .....	183
<b><i>Viewing Relationships for a Single Device</i></b> .....	<b>184</b>
<b><i>Viewing Device Topology Maps</i></b> .....	<b>185</b>
<i>Viewing Device Topology Maps in the Classic SL1 User Interface</i> .....	187
<b><i>Defining Device Relationships</i></b> .....	<b>188</b>
<b><i>Device Categories that Don't Support Parent-Child Devices</i></b> .....	<b>189</b>
<b><i>Event Correlation</i></b> .....	<b>190</b>
<i>Events that May Not Be Displayed in the Events Page</i> .....	190
<i>Defining Event Correlation</i> .....	191
<b><i>Layer-2 Topology Collection</i></b> .....	<b>194</b>
<b><i>CDP Topology Collection</i></b> .....	<b>194</b>

## What are Device Relationships?

SL1 automatically defines parent and child relationships for certain devices. Users can also manually define some types of relationships. Devices can have the following types of relationships:

- Layer-2 devices and their clients. Layer-2 relationships are automatically discovered by SL1 and can be created in the **Subnet Map (L2)** page (Maps > Classic Maps > Topology Maps > Layer-2).
- Layer-3 devices and layer-2 devices. Layer-3 relationships are automatically discovered by SL1 and can be created in the **Layer 3 Map** page (Maps > Classic Maps > Topology Maps > Layer-3).
- Network devices that use CDP (Cisco Discovery Protocol) and devices that are specified as neighbors in the CDP tables. CDP relationships are automatically discovered by SL1 and can be created in the **Subnet Map (CDP)** page (Maps > Classic Maps > Topology Maps > CDP).
- Network devices that use LLDP (Link Layer Discovery Protocol) and devices that are specified as neighbors in the LLDP tables. LLDP relationships are automatically discovered by SL1 and can be created in the **Classic Maps > Topology Maps > LLDP** page (Maps > Classic Maps > Topology Maps > LLDP).
- Component devices and their parent devices using Dynamic Application data. For example, virtual machines and their hypervisors.
- Device relationships between root devices, parent devices, and component devices (Component Mapping).
- Device relationships created using Dynamic Application data. For example, the Dynamic Applications in the VMware vSphere and NetApp PowerPacks are configured to create relationships between VMware Datastore component devices and their associated NetApp Volume component devices.
- Generic parent-child relationships, sometimes referred to as Event Correlation relationships or Ad-Hoc relationships, can be manually created. These relationships can be created in the **Device Children** page for the parent device.

**NOTE:** SL1 also automatically discovers relationships between VMWare hypervisors and VMWare virtual machines using SNMP data, but *only for legacy versions VMWare ESX 3.5 and VMWare ESX 4.x*.

All device relationships are displayed as child and parent relationships. For example:

- A layer-2 switch is a parent device and a firewall attached to the switch is a child device.
- A layer-3 router is a parent device and a layer-2 switch attached to the router is a child device.
- A VMware ESX server is a parent device and a Linux VM on that server is a child device.

---

## Viewing the List of Device Relationships

The **Device Relationships** page displays information about every parent-child relationship that has been automatically created by SL1 or manually defined by a user.

For each child device, the **Device Relationships** page displays at least the MAC address of the child interface and, if possible, the device name of the child device, the IP address associated with the child interface, the name of the child interface, and the manufacturer of the child interface.

For each parent device, the **Device Relationships** page displays the device name, the name of the parent interface, the MAC address of the parent interface, and the manufacturer of the parent interface.

For example, suppose a switch has been discovered by SL1. Suppose that 12 interfaces on that switch are in use. Suppose that only three of those 12 interfaces are connected to child interfaces that have been discovered by SL1. The **Device Relationships** page will display whatever ARP information SL1 can retrieve about the remaining nine child interfaces. In most cases, SL1 can retrieve the MAC address and manufacturer associated with the child interface, even if the child interface has not been discovered by SL1.

The relationships in the **Device Relationships** page are dynamically updated. If SL1 discovers a new relationship, SL1 updates the **Device Relationships** page.

You can view information for each parent-child relationship between two devices managed by SL1 or for a single parent device managed by SL1 and an unknown child device. To view information on **Device Relationships**:

1. Go to the **Device Relationships** page (Registry > Networks > Device Relationships).

2. The **Device Relationships** page displays the following information:

**TIP:** You can sort the list of user device relationships by column. To sort by ascending column value, click on a column heading. To sort by descending column value, click on the same column heading a second time.

**NOTE:** The **Device Relationships** page respects multi-tenancy rules. This means that you can view relationships in this page only if both devices are aligned with an organization of which you are a member.

Child	Child IP	Child Interface	Child Phys Addr	Child IF Manufacturer	Parent	Parent Interface	Parent IF Alias	Parent Phys Addr	Parent IF Manufacturer	Type
AIDAHXVQSNXTLUBFOWYE	--	--	--	--	AWS SE Sandbox	--	--	--	--	Component Mapping
ap-northeast-1 CloudTrail Service	--	--	--	--	Tokyo: ap-northeast-1	--	--	--	--	Component Mapping
ap-northeast-1 CloudWatch Serv	--	--	--	--	Tokyo: ap-northeast-1	--	--	--	--	Component Mapping
ap-northeast-1 default	--	--	--	--	ap-northeast-1 Security	--	--	--	--	Component Mapping
ap-northeast-1 default	--	--	--	--	ap-northeast-1 vpc-d8170b8	--	--	--	--	Component Relationship
ap-northeast-1 rtb-01e01264	--	--	--	--	ap-northeast-1 vpc-d8170b8	--	--	--	--	Component Mapping
ap-northeast-1 sciencelagic-it-aw	--	--	--	--	ap-northeast-1 CloudTrail Service	--	--	--	--	Component Mapping
ap-northeast-1 Security	--	--	--	--	Tokyo: ap-northeast-1	--	--	--	--	Component Mapping
ap-northeast-1 subnet-152c563d	--	--	--	--	ap-northeast-1 vpc-d8170b8	--	--	--	--	Component Mapping
ap-northeast-1 subnet-62a05115	--	--	--	--	ap-northeast-1 vpc-d8170b8	--	--	--	--	Component Mapping
ap-northeast-1 subnet-c0140188	--	--	--	--	ap-northeast-1 vpc-d8170b8	--	--	--	--	Component Mapping
ap-northeast-1 VPC Service	--	--	--	--	Tokyo: ap-northeast-1	--	--	--	--	Component Mapping
ap-northeast-1 vpc-d8170b8	--	--	--	--	ap-northeast-1 VPC Service	--	--	--	--	Component Mapping
ap-northeast-1a	--	--	--	--	Tokyo: ap-northeast-1	--	--	--	--	Component Mapping
ap-northeast-1c	--	--	--	--	Tokyo: ap-northeast-1	--	--	--	--	Component Mapping
ap-northeast-1d	--	--	--	--	Tokyo: ap-northeast-1	--	--	--	--	Component Mapping
ap-northeast-2 CloudTrail Service	--	--	--	--	Seoul: ap-northeast-2	--	--	--	--	Component Mapping
ap-northeast-2 CloudWatch Serv	--	--	--	--	Seoul: ap-northeast-2	--	--	--	--	Component Mapping
ap-northeast-2 default	--	--	--	--	ap-northeast-2 Security	--	--	--	--	Component Mapping

- **Child.** If the child device has been discovered by SL1, this column contains the name of the device and a link to the **Device Relationships** page for the child device.
- **Child IP.** If the child device has been discovered by SL1, this column contains the IP address through which the child communicates with the parent device.
- **Child Interface.** If the child device has been discovered by SL1, this column contains the name of the interface through which the child device communicates with the parent device and a link to the **Interfaces Found** page for the child interface.
- **Child Phys Addr.** The physical address (MAC address) for the interface through which the child device communicates with the parent device.
- **Child IF Manufacturer.** If included in the MAC address, the manufacturer of the child interface.
- **Parent.** The name of the parent device and a link to the **Device Relationships** page for the parent device.
- **Parent Interface.** The name of the interface through which the parent device communicates with the child device and a link to the **Interfaces Found** page for the parent interface.
- **Parent IF Alias.** Easy-to-remember, human-readable name for the interface on the parent device.
- **Parent Phys Addr.** The physical address (MAC address) for the interface through which the parent

device communicates with the child device.

- **Parent IF Manufacturer.** If included in the MAC address, the manufacturer of the parent interface.
- **Type.** Describes the relationship between the parent device and child device. Possible values are:
  - CDP
  - LLDP
  - Component Mapping
  - Component Relationship
  - Event Correlation
  - Layer-2
  - Layer-3
  - VMware

## Filtering the List of Device Relationships

You can filter the list on the **Device Relationships** page by one or more parameters. Only device relationships that meet all the filter criteria will be displayed in the **Device Relationships** page.

To filter by parameter, enter text into the desired filter-while-you-type field. The **Device Relationships** page searches for device relationships that match the text, including partial matches. By default, the cursor is placed in the left-most filter-while-you-type field. You can use the <Tab> key or your mouse to move your cursor through the fields. The list is dynamically updated as you type. Text matches are not case-sensitive.

You can also use special characters to filter each parameter.

Filter by one or more of the following parameters:

- **Child.** You can enter text to match, including special characters, and the **Device Relationships** page will display only device relationships that have a matching device name on the child device.
- **Child IP.** You can enter text to match, including special characters, and the **Device Relationships** page will display only device relationships that have a matching IP address on the child interface.
- **Child Interface.** You can enter text to match, including special characters, and the **Device Relationships** page will display only device relationships that have a matching name on the child interface.
- **Child Phys Addr.** You can enter text to match, including special characters, and the **Device Relationships** page will display only device relationships that have a matching MAC address on the child interface.
- **Child IF Manufacturer.** You can enter text to match, including special characters, and the **Device Relationships** page will display only device relationships that have a matching manufacturer for the child interface.
- **Parent.** You can enter text to match, including special characters, and the **Device Relationships** page will display only device relationships that have a device name on the parent device.
- **Parent Interface.** You can enter text to match, including special characters, and the **Device Relationships** page will display only device relationships that have a matching name on the parent interface.

- **Parent IF Alias.** You can enter text to match, including special characters, and the **Device Relationships** page will display only device relationships that have a matching IF alias on the parent interface.
- **Parent Phys Addr.** You can enter text to match, including special characters, and the **Device Relationships** page will display only device relationships that have a matching MAC address on the parent interface.
- **Parent IF Manufacturer.** You can enter text to match, including special characters, and the **Device Relationships** page will display only device relationships that have a matching manufacturer for the parent interface.
- **Type.** You can enter text to match, including special characters, and the **Device Relationships** page will display only device relationships that have a matching type.

## Viewing Relationships for a Single Device

You can view all links for a single device on the **Relationships** tab of the **Device Investigator** (or on the **Device Relationships** page in the **Device Properties** panel in the classic SL1 user interface).

To view all links for a single device:

1. Go to the **Relationships** tab of the **Device Investigator**. (Alternatively, in the classic SL1 user interface, go to the **Device Manager** page (Devices > Device Manager), click the wrench icon for a device (  ) and click the **[Relationships]** tab in the **Device Properties** pane.) The **Device Relationships** page appears.
2. The left pane of the **Device Relationships** page displays links to parent devices. The right pane of the **Device Relationships** page displays links to child devices. For each relationship, the **Device Relationships** page displays the following information:

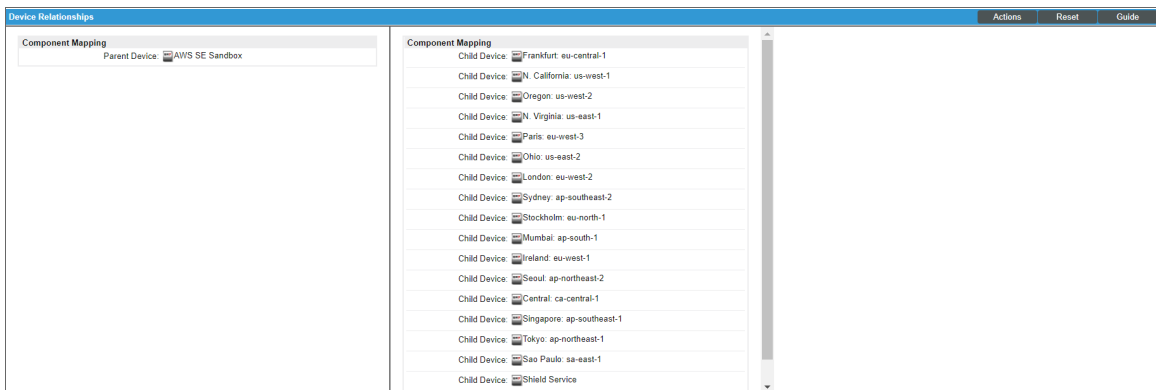

- **Type of relationship.** Possible values are:
  - *Layer 2.* Layer-2 devices and their clients.
  - *Layer 3.* Layer-3 devices and layer-2 devices.
  - *VMware.* Hypervisors and their virtual machines.
  - *CDP.* Network devices that use CDP (Cisco Discovery Protocol) and devices that are specified as neighbors in CDP tables.



- *LLDP*. Network devices that use LLDP (Link Layer Discovery Protocol) and devices that are specified as neighbors in LLDP tables.
- *Event Correlation*. Relationships defined manually by users through the user interface.
- *Component Mapping*. Relationships defined using Dynamic Applications.
- **Parent Device**. The name of the parent device and a link to the **Device Properties** page for the parent device.
- **Parent Interface**. The name of the interface through which the parent device communicates with the child device and a link to the **Interfaces Found** page for the parent interface.
- **Child Device**. The name of the child device and a link to the **Device Properties** page for the child device.
- **Child Interface**. The name of the interface through which the child device communicates with the parent device and a link to the **Interfaces Found** page for the child interface.

**NOTE:** Clicking on a device reloads the **Device Relationships** page and makes the selected device the primary device.

## Viewing Device Topology Maps

On the **[Map]** tab in the **Device Investigator**, you can view a map of the selected device and all of the devices with which the device has relationships:

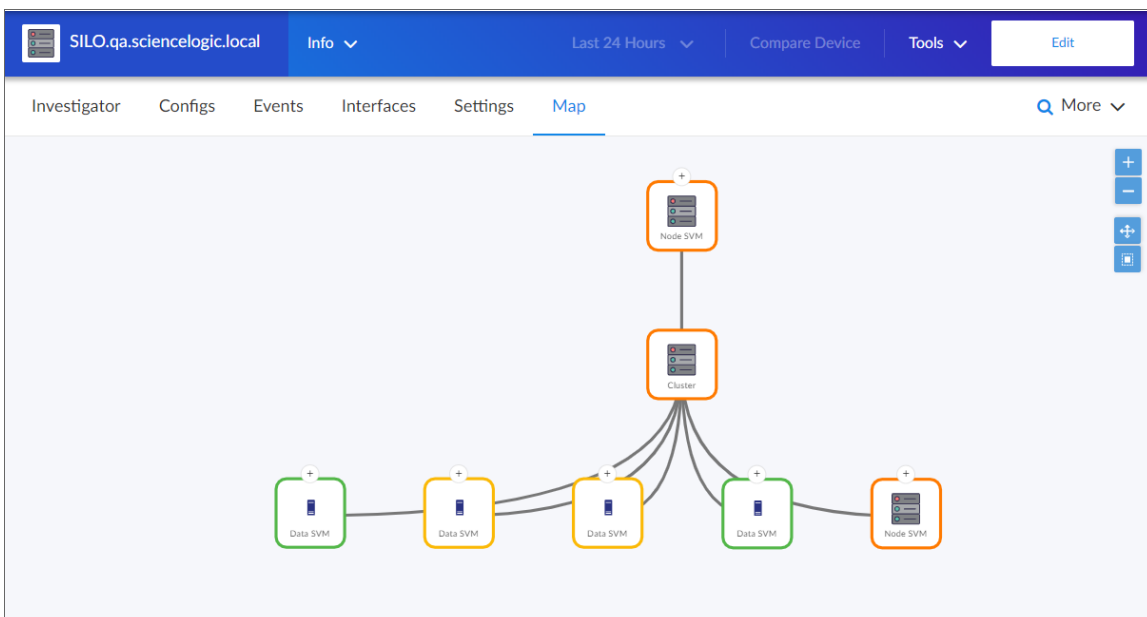

These relationships include:

- Layer-2 devices and their clients





- Layer-3 devices and Layer-2 devices
- Component devices and their parent devices. For example, virtual machines and their hypervisors and their virtual machines.
- Network devices that use CDP (Cisco Delivery Protocol) and devices that are specified as neighbors in CDP tables
- Links between network devices that use CDP (Cisco Discovery Protocol) and devices that are specified as neighbors in CDP tables
- Network devices that use LLDP (Link Layer Delivery Protocol) and devices that are specified as neighbors in LLDP tables
- Links between network devices that use LLDP (Link Layer Discovery Protocol) and devices that are specified as neighbors in LLDP tables
- Device relationships between root devices, parent devices, and component devices (Component Mapping)
- Device relationships created with Dynamic Applications
- Manually created parent-child relationships that affect event correlation

A map includes the following graphical elements:

- **Nodes.** Shapes that represent Devices, Topology Elements, and Business Services defined in SL1. The shape of a node represents its type, and the color of its outline specifies the current state of the node.
- **Edges.** Lines with or without arrows that represent the relationships and hierarchies between nodes. All device relationships are displayed as child and parent relationships. If the nodes on a map contain arrows, then the arrows represent the direction of the relationship, pointing from the child node to its parent node. If a node does not contain an arrow, then the relationship is bi-directional, or *undirected*.

When you hover your mouse over a device icon on the map, a pop-up window appears that displays information about that device. Click the device name in the pop-up window to go to the **Device Investigator** for that device.

You can use the icons on the page to do the following:

- Increase the map size 
- Decrease the map size 
- Fit all of the map elements into the viewing pane 
- Center the selected elements of a map in the viewing pane 

## Viewing Device Topology Maps in the Classic SL1 User Interface

The **Device View** page appears when a user clicks the **Topology** tab in the Device Reports panel. The **Device View** page displays a map of the device and all of the devices with which the device has relationships.

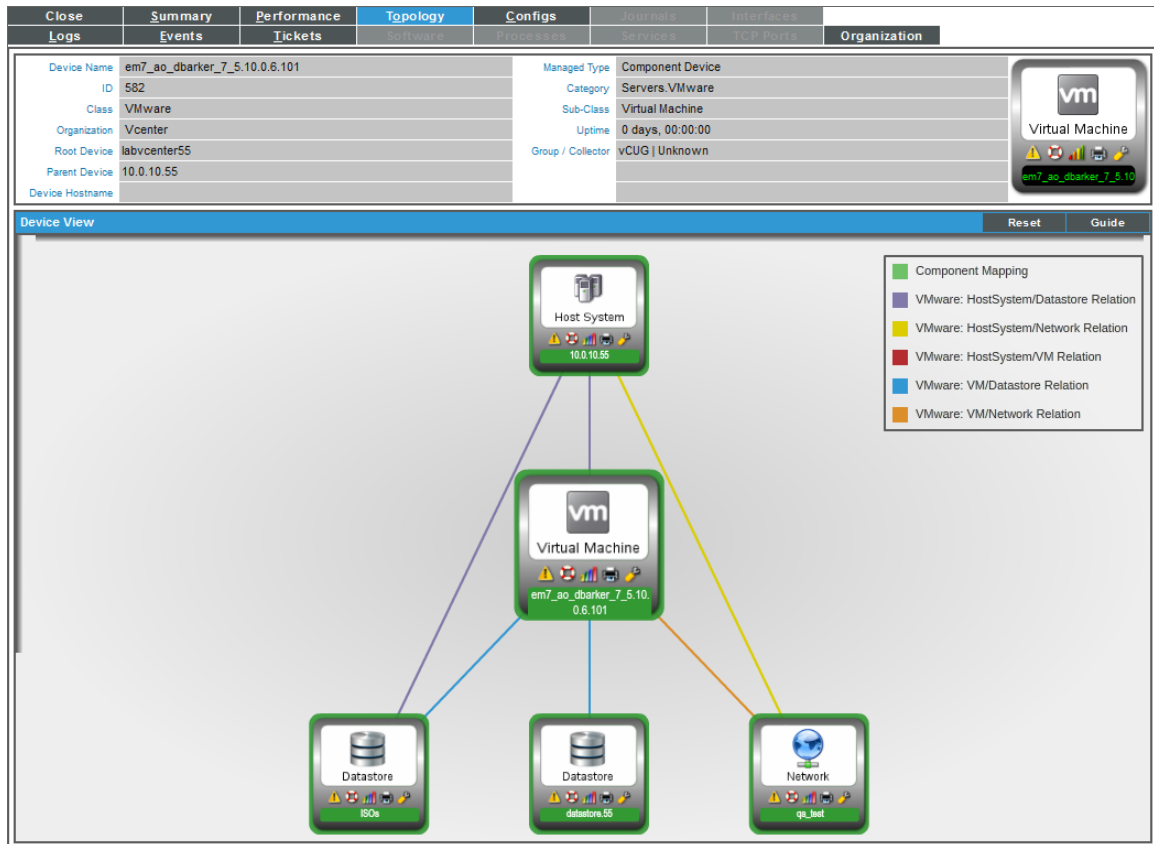

These relationships include:

- Layer-2 devices and their clients
- Layer-3 devices and Layer-2 devices
- Component devices and their parent devices. For example, virtual machines and their hypervisors and their virtual machines.
- Network devices that use CDP (Cisco Delivery Protocol) and devices that are specified as neighbors in CDP tables
- Links between network devices that use CDP (Cisco Discovery Protocol) and devices that are specified as neighbors in CDP tables
- Network devices that use LLDP (Link Layer Delivery Protocol) and devices that are specified as neighbors in LLDP tables

- Links between network devices that use LLDP (Link Layer Discovery Protocol) and devices that are specified as neighbors in LLDP tables
- Device relationships between root devices, parent devices, and component devices (Component Mapping)
- Device relationships created with Dynamic Applications
- Manually created parent-child relationships that affect event correlation

**NOTE:** Double-clicking on a device reloads the **Device View** page and makes the selected device the primary device.

For details on the toolbars that appear in this page, see the **Views** manual.

---

## Defining Device Relationships

The **Device Children** modal page allows users to select one or more devices to become children of the currently selected device.

**NOTE:** You cannot manually create parent-child relationships for devices with a **Device Category** of *Virtual*. Parent-child relationships for virtual devices can be established only during discovery, when a virtual device acts as the root device for a dynamic component map (DCM) tree.

To add children to a device:

1. Go to the **Relationships** tab of the **Device Investigator**. (Alternatively, in the classic SL1 user interface, go to the **Device Manager** page (Devices > Device Manager), click the wrench icon for a device () and click the **[Relationships]** tab in the **Device Properties** pane.) The **Device Relationships** page appears.

2. Click the **[Actions]** button and then select *Device Children*. The **Device Children** modal page appears:

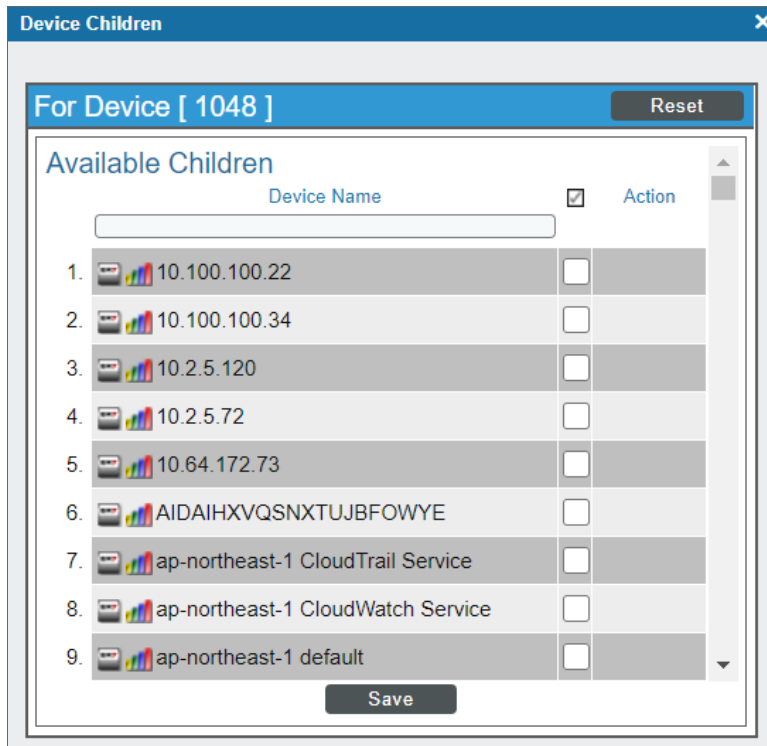

3. In the **Device Children** page, select one or more devices to be children of the current device.
4. Click **[Save]**.

---

## Device Categories that Don't Support Parent-Child Devices

A device category is a logical categorization of a device by primary function. SL1 uses device categories to group related devices in reports and views.

Device categories are paired with device classes to organize and describe discovered devices. The device class usually describes the manufacturer and model of a device. The device category describes the function of the hardware.

Devices that are members of the following device categories cannot be assigned children devices:

- Office Printers, Device Category #4
- Workstations, Device Category #6
- Environmental.Utility, Device Category #8
- Environmental.HVAC, Device Category #9
- Environmental.Security, Device Category #10
- System.Tape, Device Category #17

- Office.Copiers, Device Category #22
- Office.Facsimiles, Device Category #23
- Telephony.Phone, Device Category #36
- Office.Plotter, Device Category #40
- Pingable, Device Category #98
- Virtual, Device Category #97

To determine a device's device category, look in the *Category* field on the **Devices** page or in the Info box in the **Device Investigator**. (Alternatively, in the classic SL1 user interface, you can view the *Category* field on any page in the **Device Administration** or **Device Management** pages.)

---

## Event Correlation

In SL1, event correlation means the ability to build parent-child relationships between devices and their events. When events are correlated, only the parent event is displayed in the **Events** page.

- In the **Events** page, the child events are rolled up and nested under the parent event and are displayed only if you click on the magnifying-glass icon (  ).
- For the parent event, the **Count** column will be incremented to indicate the number of correlated child events.

For details on event correlation, see the manual titled **Events**.

## Events that May Not Be Displayed in the Events Page

In SL1, there are four types of events that might not be displayed in the **Events** page:

- **Rolled-up events.** Multiple occurrences of the same event on the same device. When the same event occurs multiple times on a single device, SL1 does not display each occurrence in the **Events** page. Instead, SL1 displays a single entry and notes the number of occurrences in the **Count** column.
- **Suppressed Events.** Suppressed events do not appear in the **Events** page.
- **Topology Events.** In SL1, event correlation or topology suppression means the ability to build parent-child relationships between devices and between events. When events are correlated, only the parent event is displayed in the **Events** page. The magnifying-glass icon (  ) appears to the left of the parent event. When you click on the magnifying-glass icon, the list of child events is displayed. The child events are rolled up under the parent event and are not displayed in the **Events** page. For the parent event, the count column will be incremented to indicate the number of correlated child events. Optionally, you can define event categories that allow SL1 to more efficiently align suppressing events with suppressible events. When you align an event category to a suppressing or suppressible event, that event will be correlated with only events that are aligned with the same event category.

- **Event Masks.** In the **Device Properties** page for each device, you can define an Event Mask. When a device uses the Event Mask setting, events that occur on a single device within a specified span of time are grouped together. In the **Events** page, masked events are displayed under a single event, the one with the highest severity. The magnifying-glass icon () appears to the left of the event. When you click on the magnifying-glass icon, the list of all events that are masked under event is displayed.

## Defining Event Correlation

To manually configure event correlation in the classic SL1 user interface, you must define two types of events:

- **Suppressing events.** If this event occurs on a parent device, SL1 will search all related children devices for **suppressible** events. On the children devices, all suppressible events will be suppressed. Only the suppressing event will appear in the **Events** page (or the **Event Console** page in the classic SL1 user interface) . The suppressible events will not appear in the **Events** page (or the **Event Console** page in the classic SL1 user interface) .
- **Suppressible events.** This type of event is suppressed on a child device only when a suppressing event occurs on the parent device.

**NOTE:** If you configure event categories, the suppressing and suppressible events must be associated with the same category for correlation to occur. If you do not configure event categories, each and every suppressing event that occurs on a parent device will cause SL1 to suppress **all suppressible** events on the associated children devices.

To define an event as a suppressing event on the **Event Policy Manager** page in the classic SL1 user interface):

1. Go to the **Event Policy Manager** page (Registry > Events > Event Manager).
2. On the **Event Policy Manager** page, click the wrench icon () of the event that you want to define as the **suppressing** event. The **Event Policy Editor** page appears.
3. On the **Event Policy Editor** page, click the **[Advanced]** tab.

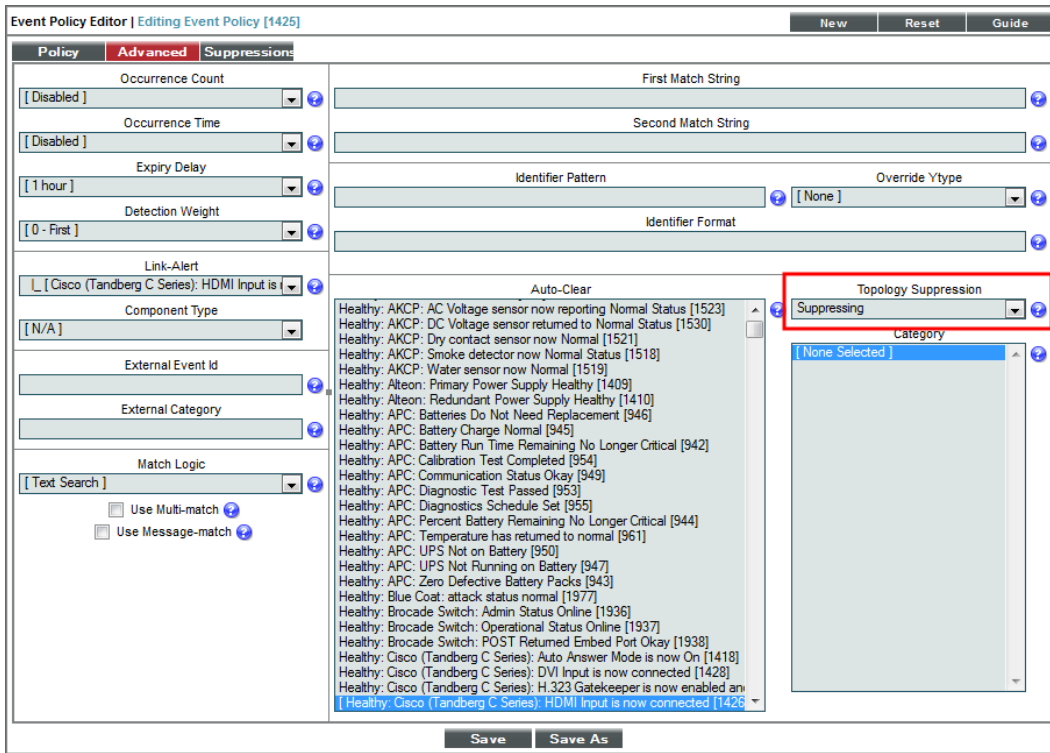

4. In the **Topology Suppression** field, select *Suppressing*.
5. Click **[Save]**. In the future, when this event occurs on a device, SL1 will check if the device is a parent device. If the device is a parent device, specified events (suppressible events) with the same category will be suppressed on the children devices.

To define an event as a suppressible event on the **Event Policy Manager** page in the classic SL1 user interface:

1. Go to the **Event Policy Manager** page (Registry > Events > Event Manager).
2. On the **Event Policy Manager** page, click the wrench icon (🔧) of the event that you want to define as the **Suppressible** event. The **Event Policy Editor** page appears.
3. On the **Event Policy Editor** page, click the **[Advanced]** tab.



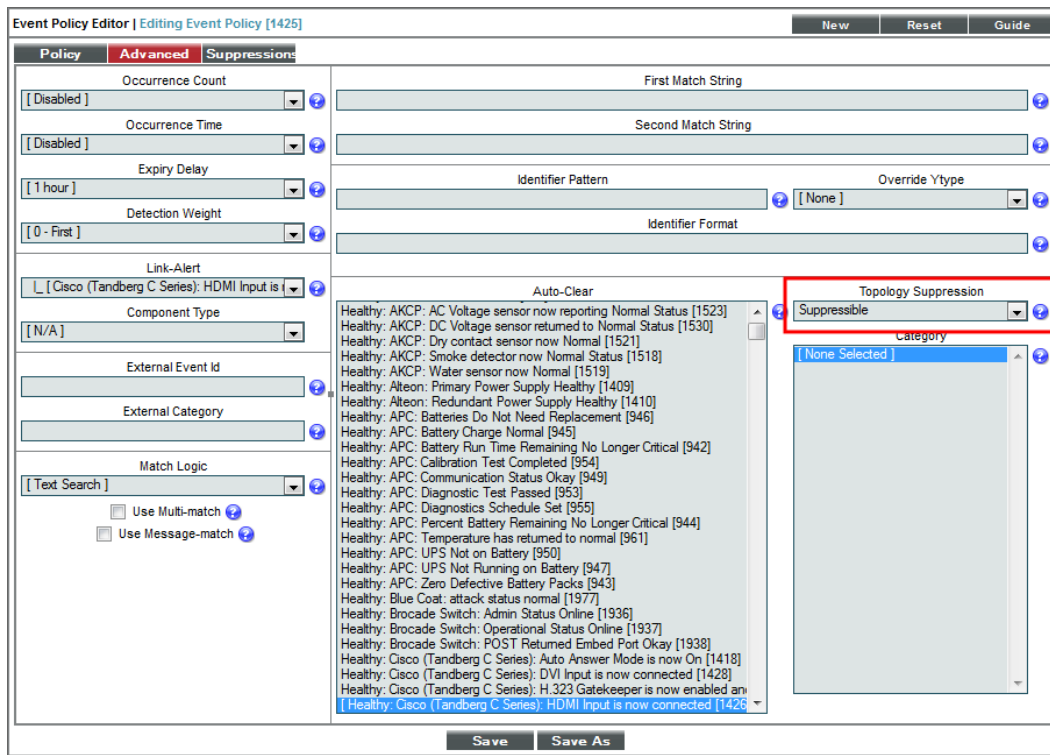

4. In the **Topology Suppression** field, select *Suppressible*.
5. Click **[Save]**. In the future, when this event occurs on a device, SL1 will check if the device is a child device. If the device is a child device, SL1 will check to see if a suppressing event with the same category has occurred on the parent device. If a suppressing event has occurred on the parent device, the specified event will be suppressed on the child device.

For example:

- Suppose you have a device named *Boise-DMZ*. Suppose this device is a Cisco Catalyst switch. Suppose we define this switch as a parent device.
- Suppose we have a device named *HQ-W2K3-VC01*. Suppose this device is a server. Suppose we define this server as a child device to *Boise-DMZ*.
- Suppose we define the event "Poller: Interface operationally down" as a suppressing event.
- Suppose we define the event "Poller: Device not responding" as a suppressible event.
- Suppose we associate both events with the same event category.
- If an interface goes down on the switch *Boise-DMZ*, SL1 will not be able to communicate with the server, *HQ-W2K3-VC01*, attached to the switch.
- So if the event "Poller: Interface operationally down" occurs on *Boise-DMZ*, the event "Poller: Device not responding" will be suppressed on the server *HQ-W2K3-VC01*. On the **Events** page (or the **Event Console** page in the classic SL1 user interface), only the event "Poller: Interface operationally down" on the device *Boise-DMZ* will appear.

---

## Layer-2 Topology Collection

A layer-2 topology record describes a direct network connection between a parent device (a Network Switch or Network Bridge) and a child device. The child device is either:

- Another bridge device discovered in SL1
- Another type of device that is discovered in SL1
- A device that is not discovered in SL1

Every hour, SL1 collects information from the Bridge-MIB from all discovered network switches and bridges. Network switches and bridges that support the Bridge-MIB report information about all MAC addresses for which that network switch or bridge has forwarding information.

During collection, SL1 performs the following steps:

- Compiles a list of all devices to poll. SL1 polls devices that have a **Device Category** of "Network.Switches" (ID 2) or "Network.Bridges" (ID 19). The **Device Category** is defined in the Device Class assigned to the device.
- If the **Enable Community String Indexing (VLAN Topology)** checkbox is selected in the **Behavior Settings** page (System > Settings > Behavior), SL1 compiles a list of vLANs for which data should be collected using the CISCO-VTP-MIB. A vLAN is added to the list of vLANs only if the vLAN state is 1 (operational) and the vLAN type is 1 (ethernet). If the **Enable Community String Indexing (VLAN Topology)** option is disabled, SL1 performs collection for vLAN 1 only.
- For each vLAN on each device, SL1 polls the Bridge-MIB to collect the list of all MAC addresses for which that network switch or bridge has forwarding information.
- SL1 stores a MAC address record if:
  - The status of the record is "3" (learned).
  - An ifIndex value was collected successfully for the associated port index.

The information collected from the Bridge-MIB does not explicitly indicate which devices are directly connected to a network switch or bridge; switches and bridges will report forwarding information for MAC addresses that are several network hops away from the switch or bridge. A second "crunch" process creates layer-2 topology relationships by evaluating all of the collected MAC address records holistically.

---

## CDP Topology Collection

A CDP Topology record describes a direct network connection between a parent device (a Network Switch or Network Router) and a child device. CDP stands for "Cisco Discovery Protocol," a proprietary standard that is used by networking devices to communicate configuration information to the other devices in the network. Devices that support CDP store and report information received about their immediate neighbors.

CDP is a proprietary protocol developed by Cisco and is not supported by all network hardware. If your network includes both CDP-enabled and non-CDP network switches and routers, the topology data reported by the CDP-enabled devices might not be accurate.

Suppose a network includes three switches connected in the following way:

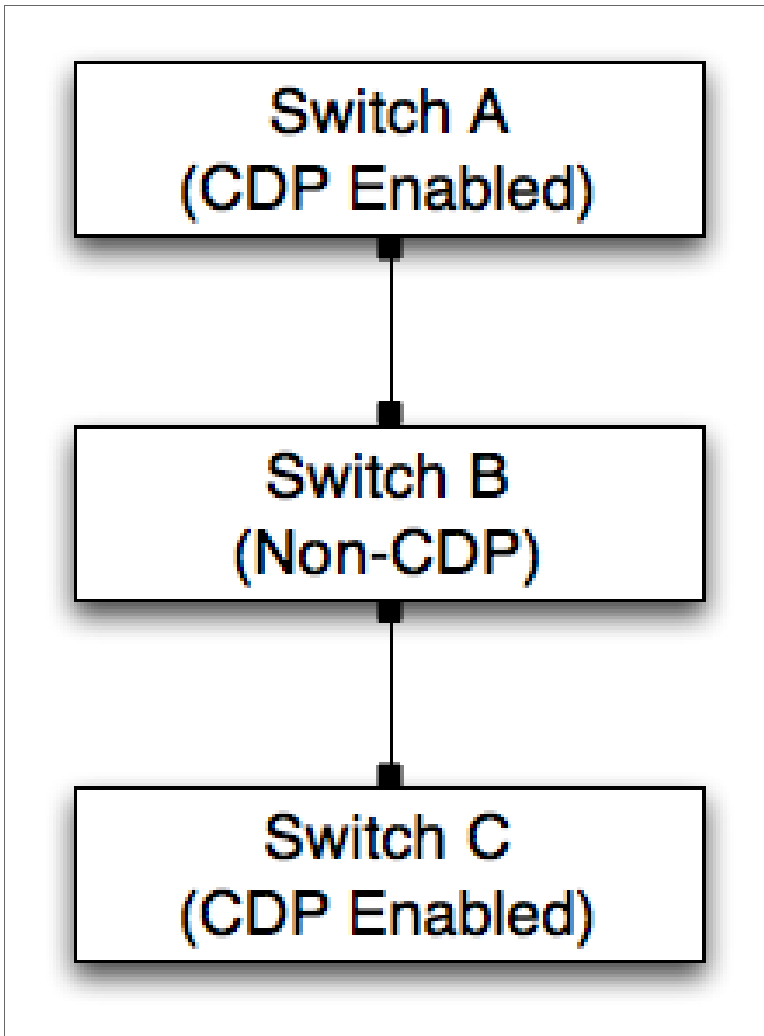

- Switch A and Switch C, which are both CDP-enabled, broadcast CDP messages.
- Because Switch B is not CDP-enabled, the broadcast messages from Switch A will reach Switch C. Therefore, Switch C will report that it is directly connected to Switch A.
- Conversely, the broadcast messages from Switch C will reach Switch A. Therefore, Switch A will report that it is directly connected to Switch C.

In addition to the CDP data collected from the switches in this example, SL1 might also collect layer-2 topology data that can be used to create correct topology links. However, each discovered interface can be associated with only one topology record of **any** type. If a conflict exists between the collected CDP topology data and the collected layer-2 topology data, the CDP topology data takes precedence. In the example above, the CDP topology data will be inaccurate, but the layer-2 data might be accurate. Therefore, if your network includes both CDP-enabled and non-CDP network switches and routers, you might want to disable CDP topology collection in the **Behavior Settings** page (System > Settings > Behavior).

If CDP collection is enabled, SL1 collects information from the Cisco-CDP-MIB from all discovered network switches and routers. SL1 polls devices that have a **Device Category** of "Network.Switches" (ID 2) or "Network.Routers" (ID 1). The **Device Category** is defined in the Device Class assigned to the device. Network switches and routers that support the Cisco-CDP-MIB report the IP address and interface information for all directly connected devices that are CDP-enabled.

**NOTE:** Although SL1 polls all network switches and routers for CDP information, not all network switches and routers support CDP.

Each discovered interface can be associated with only one topology record of **any** type. Therefore, the same "crunch" process that creates layer-2 topology records is also responsible for creating the CDP records based on the collected data. However, unlike layer-2 topology records, the Cisco-CDP-MIB reports only directly connected devices. Therefore, if all associated interfaces are valid and available, there is a 1:1 mapping between collected CDP relationships and the CDP relationships created by the "crunch" process.

To view CDP maps, go to the **Subnet Map (CDP)** page (Views > Topology Maps > CDP). For details on viewing CDP maps, see the **Views** manual.

---

## LLDP Topology Collection

An LLDP topology record describes a direct network connection between a parent device (a Network Switch or Network Router) and a child device. LLDP stands for "Link Layer Discovery Protocol," a standard used by networking devices to communicate configuration information to the other devices in the network. Devices that support LLDP store and report information received about their immediate neighbors.

If your network includes both LLDP-enabled and non-LLDP network switches and routers, the topology data reported by the LLDP enabled devices might not be accurate.

Suppose a network includes three switches connected in the following way:

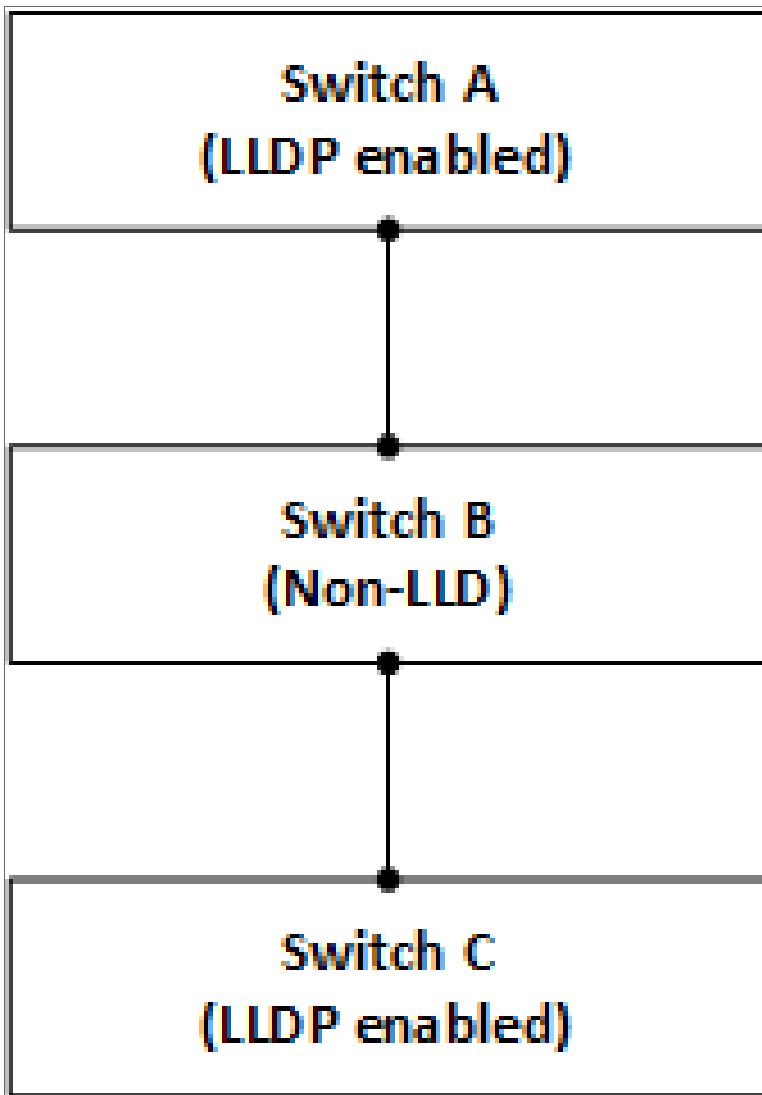

- Switch A and Switch C, which are both LLDP-enabled, broadcast LLDP messages.
- Because Switch B is not LLDP-enabled, the broadcast messages from Switch A will reach Switch C. Therefore, Switch C will report that it is directly connected to Switch A.
- Conversely, the broadcast messages from Switch C will reach Switch A. Therefore, Switch A will report that it is directly connected to Switch C.

In addition to the LLDP data collected from the switches in this example, SL1 might also collect Layer-2 topology data that can be used to create correct topology links. However, each discovered interface can be associated with only one topology record of **any** type. If a conflict exists between the collected LLDP topology data and the collected Layer-2 topology data, the LLDP topology data takes precedence. In the example above, the LLDP topology data will be inaccurate, but the Layer-2 data might be accurate. Therefore, if your network includes both LLDP-enabled and non-LLDP network switches and routers, you might want to disable LLDP topology collection in the **Behavior Settings** page (System > Settings > Behavior).

If LLDP collection is enabled, SL1 collects information from the LLDP MIB from all discovered network switches and routers. SL1 polls devices that have a **Device Category** of "Network.Switches" (ID 2) or "Network.Routers" (ID 1). The **Device Category** is defined in the Device Class assigned to the device. Network switches and routers that support the Cisco-LLDP-MIB report the IP address and interface information for all directly connected devices that are LLDP-enabled.

**NOTE:** Although SL1 polls all network switches and routers for LLDP information, not all network switches and routers support LLDP.

Each discovered interface can be associated with only one topology record of **any** type. Therefore, the same "crunch" process that creates Layer-2 topology records is also responsible for creating the LLDP records based on the collected data. However, unlike Layer-2 topology records, the -LLDP MIB reports only directly connected devices. Therefore, if all associated interfaces are valid and available, there is a 1:1 mapping between collected LLDP relationships and the LLDP relationships created by the "crunch" process.

---

## Layer-3 Topology Collection

Layer-3 topology records are created by performing a traceroute command from a Data Collector or the All-In-One Appliance to the discovered network hardware every two hours:

- For each "hop" in a traceroute that specifies an IP address associated with a discovered device, SL1 creates a layer-3 topology record that connects the device from the previous hop to the device for the current hop.
- Layer-3 topology records are created only when both devices are discovered; layer-3 topology records are not created when one or both of the two devices is unknown.
- If the IP address associated with a hop is associated with an unknown device, SL1 does not store that hop or any subsequent hops for that traceroute.
- Layer-3 topology records describe only that two devices are connected; layer-3 topology records do not describe which interfaces on those devices are connected.

For SL1 to create layer-3 topology records, the following requirements must be met:

- All traceroute commands for layer-3 topology collection originate from Data Collectors or an All-In-One Appliance. Therefore, the parent node(s) in the layer-3 topology is always a Data Collector or the All-In-One Appliance. For SL1 to create layer-3 topology records, all Data Collectors and All-In-One Appliances must be discovered.

- SL1 performs traceroute commands to devices that have the **L3 Topology** option enabled. The **L3 Topology** option is defined in the device class assigned to a device. For SL1 to perform layer-3 topology collection, at least one device in your system must have the **L3 Topology** option enabled in the device class.
- Your network configuration must allow the traffic generated by the traceroute commands. To test whether your network allows this traffic, go to the **Device Toolbox** page (by clicking the **[Toolbox]** tab in the **Device Administration** panel) for a device with the **L3 Topology** option enabled, and then click the **Traceroute** icon.

**NOTE:** A device that has the **L3 Topology** option disabled can still be associated with a layer-3 topology record. If an IP address associated with a device that has the **L3 Topology** option disabled appears as a "hop" in a traceroute command performed for a different device, the device with the **L3 Topology** option disabled will be associated with the layer-3 topology records that represent the hops to and from that device.

---

# Chapter

# 9



## Device Maintenance

---

### Overview

This chapter describes the ways in which you can maintain devices in SL1.

Use the following menu options to navigate the SL1 user interface:

- To view a pop-out list of menu options, click the menu icon ().
- To view a page containing all of the menu options, click the Advanced menu icon (  ).

This chapter includes the following topics:

<i>What is Scheduled Maintenance?</i> .....	201
<i>What is User Maintenance?</i> .....	202
<i>The Maintenance Minimum Severity Setting</i> .....	202
<i>Enabling and Disabling User Maintenance for a Single Device</i> .....	202
<i>Enabling and Disabling User Maintenance for One or More Devices</i> .....	205
<i>Scheduling Maintenance for a Single Device</i> .....	206
<i>Viewing the Schedule Manager</i> .....	206
<i>Defining a Scheduled or Recurring Device Maintenance Window for a Single Device</i> .....	207
<i>Scheduling Maintenance for One or More Devices</i> .....	210
<i>Enabling or Disabling Scheduled Maintenance for One or More Devices</i> .....	211
<i>Deleting Scheduled Maintenance for One or More Devices</i> .....	212



---

## What is Scheduled Maintenance?

Scheduled Maintenance is a date and time when a device is put into "maintenance mode". During maintenance mode, for the selected devices SL1 will generate only events with a severity less than the system-wide **Maintenance Minimum Severity** setting. By default, no events are generated during maintenance. You can choose to enable or disable polling during maintenance mode. Even if polling is enabled, SL1 will collect information from the selected devices but will not generate applicable events for the devices.

SL1 includes tools that allow you to view, edit, and define scheduled maintenance for one or more devices. The **Schedule Manager** page allows you to schedule one-time and recurring maintenance tasks and downtime for a device. You can use the scheduled maintenance to:

- Specify recurring downtime for routine maintenance (for example, a weekly database backup that occurs every Tuesday at 3 AM).
- Specify one-time downtime (for example, when upgrading software or hardware).

When a device is in maintenance, SL1 will generate only events with a severity less than the system-wide **Maintenance Minimum Severity** setting. By default, no events are generated during maintenance. You can choose to enable or disable polling during maintenance mode. Even if polling is enabled during maintenance, SL1 will collect information from the device but will not generate applicable events for the device.

You can specify a "patch window" within the larger maintenance period. The "patch window" allows SL1 to limit the suppression events to a small time-frame within the larger maintenance window. For example:

Suppose you have to patch a server that is monitored by SL1. Suppose you know you will perform this task sometime between midnight and 6:00 AM. Suppose you know that the actual patch process will require only 15 minutes of downtime for the server. In SL1, you would define a maintenance window of 24:00 - 6:00 and a patch window of 15 minutes.

1. At 24:00, SL1 generates an event saying that the server is going into maintenance mode. Because you have defined a patch window, SL1 continues to monitor this server as normal.
2. At 3:00, you apply the patch to the server. The server reboots, and SL1 generates an event saying that the server is offline. This first event within the larger maintenance window triggers the start of the patch maintenance window.
3. SL1 suppresses the event that triggered the patch maintenance window and instead generates an event "Patch Maintenance Window Opened".
4. For the next 15 minutes, SL1 will suppress all events for the device.
5. At 3:15, SL1 will generate an event for "Patch Maintenance Window Closed". This event clears the previous event "Patch Maintenance Window Opened".
6. SL1 will now generate events for the device, even though the maintenance window extends until 6:00.

**NOTE:** If the patch was applied at 5:50, the server was rebooted, and SL1 generated an event saying that the server is offline, events would be suppressed only until the end of the maintenance window, 6:00, even though the patch window is 15 minutes.

**NOTE:** If you disable an active maintenance schedule, the device will be pulled out of maintenance mode; if you re-enable the schedule during the scheduled time window, the device will return to maintenance mode.

---

## What is User Maintenance?

User maintenance is an option that allows a user to manually put a device in to "maintenance mode". During maintenance mode, for the selected devices SL1 will generate only events with a severity less than the system-wide **Maintenance Minimum Severity** setting. By default, no events are generated during maintenance. You can choose to enable or disable polling during maintenance mode. Even if polling is enabled, SL1 will collect information from the selected devices but will not generate applicable events for the devices.

User maintenance mode is not scheduled. That is, a user must manually enable user maintenance to put a device into this mode and a user must manually disable user maintenance to turn off this mode for a device. User maintenance mode overrides scheduled maintenance for a device.

User maintenance can be enabled and disabled in the user interface or through the API. For information about using the API, see the **ScienceLogic API** manual.

---

## The Maintenance Minimum Severity Setting

The global **Maintenance Minimum Severity** setting specifies the minimum severity required for an event to be suppressed during device maintenance and user maintenance. The default value is *Healthy*, which causes all events to be suppressed. To change this setting:

1. Go to the **Behavior Settings** page (System > Settings > Behavior).
2. In the **Behavior Settings** page, select a value in the **Maintenance Minimum Severity** drop-down list. The choices are *Healthy*, *Notice*, *Minor*, *Major*, or *Critical*.
3. Select the **[Save]** button. Events with a severity lower than the severity you chose will now be generated for all devices in scheduled maintenance mode and user maintenance mode.

---

## Enabling and Disabling User Maintenance for a Single Device

You can enable and disable user maintenance mode in the **Device Properties** page.

To enable or disable user maintenance mode for a device:

1. Go to the **Device Manager** page (Devices > Device Manager).

Device Manager ( Devices Found [176] )											Actions	Report	Reset	Guide
Device Name *	IP Address	Device Category	Device Class / Sub-class	OID	Organization	Current State	Collection Scope	Collection Status	SNMP Credentials	SNMP Version				
151 server-651	10.20.0.177	Office Printers	Lexmark International   Print Server	42	System	Minor	CUG1	Active	Cisco SNMPv2 - Exa V2					
152 ShorelineSwitch	10.20.0.214	Unknown	Shoreline Teleworks   OEM	15	System	Healthy	CUG1	Active	Cisco SNMPv2 - Exa V2					
153 SimpleSoft.ca.ScienceLogic.local	10.20.0.7	Servers	Microsoft   Windows Server 2008 R2	77	System	Minor	CUG1	Active	cdsmos V2					
154 SNAP920146	10.20.0.249	Storage NAS	Quantum Corp - Snap Division   Snap Server	158	System	Minor	CUG1	Active	Cisco SNMPv2 - Exa V2					
155 SCS2004102C1-Texas	10.20.0.247	Network Switches	Juniper Networks   NFX Router	152	System	Healthy	CUG1	Active	Cisco SNMPv2 - Exa V2					
156 SOM2353DX	10.20.0.188	Servers	Microsoft   Windows CE Version 3.0 (Multiple	27	System	Healthy	CUG1	Active	Cisco SNMPv2 - Exa V2					
157 Summit-1	10.20.0.92	Network Switches	Extreme Networks   Summit48s1 Version 7.1.1	101	System	Healthy	CUG1	Active	Cisco SNMPv2 - Exa V2					
158 sunprod1	10.20.0.27	Servers	NET-SNMP   Solaris	169	System	Minor	CUG1	Active	Cisco SNMPv2 - Exa V2					
159 Corey_NormouthJundtUSA	10.20.0.210	Telephony	Quantum   Genet A800	18	System	Healthy	CUG1	Active	Cisco SNMPv2 - Exa V2					
160 SV22554C1_new04	10.20.0.1	Network Switches	Cisco Systems   Catalyst 3750-Stack	76	System	Healthy	CUG1	Active	Cisco SNMPv2 - Exa V2					
161 switch	10.20.0.15	Network Switches	Brocade   ChannelAL Switch	104	System	Healthy	CUG1	Active	Cisco SNMPv2 - Exa V2					
162 landberg	10.20.0.217	Unknown	Tandberg ASA   OEM	12	System	Healthy	CUG1	Active	Cisco SNMPv2 - Exa V2					
163 jasperskic-fw1.raihostedsolutions.com	10.20.0.157	Network Firewall	Cisco Systems   ASA-5520	146	System	Minor	CUG1	Active	Cisco SNMPv2 - Exa V2					
164 TOSBI&e-STUUM451c	10.20.0.86	Unknown	Tec Corporation   OEM	124	System	Minor	CUG1	Active	Cisco SNMPv2 - Exa V2					
165 TTCComm	10.20.0.229	Unknown	Xerox   OEM	81	System	Minor	CUG1	Active	Cisco SNMPv2 - Exa V2					
166 h2.local	10.20.0.71	Network Switches	Cisco Systems   TS SEC	68	System	Healthy	CUG1	Active	Cisco SNMPv2 - Exa V2					
167 h3.local	10.20.0.72	Network Switches	Cisco Systems   TS SEC	67	System	Healthy	CUG1	Active	Cisco SNMPv2 - Exa V2					
168 FULLPTLS-ACCOUNTING	10.20.0.168	Unknown	HP   OEM	168	System	Minor	CUG1	Active	Cisco SNMPv2 - Exa V2					
169 ups1.fvm.az	10.20.0.77	Environmental UPS	APC   SmartUPS 2200	66	System	Critical	CUG1	Active	Cisco SNMPv2 - Exa V2					
170 VTI1000	10.20.0.166	Unknown	General Instrument   OEM	55	System	Healthy	CUG1	Active	Cisco SNMPv2 - Exa V2					
171 vxTarget	10.20.0.227	Telephony	Vina Technologies   Multiplexor	136	System	Healthy	CUG1	Active	Cisco SNMPv2 - Exa V2					
172 vxTarget	10.20.0.84	Servers	Empire Technologies   Default Enterprise Agent	87	System	Critical	CUG1	Active	Cisco SNMPv2 - Exa V2					
173 WLLMVS-CORE-R01	10.20.0.62	Network Router	Cisco Systems   8750	83	System	Minor	CUG1	Active	Cisco SNMPv2 - Exa V2					
174 WxGoods-1 - IT_Watchdogs, Inc.	10.20.0.228	Unknown	Generic   SNMP	78	System	Healthy	CUG1	Active	Cisco SNMPv2 - Exa V2					
175 wdxmsrv134	10.20.0.23	Servers	XenServer   Xen Host	176	System	Healthy	CUG1	Active	Cisco SNMPv2 - Exa V2					

- In the **Device Manager** page, find the device for which you want to enable or disable user maintenance. Select its wrench icon (). The **Device Properties** page is displayed:

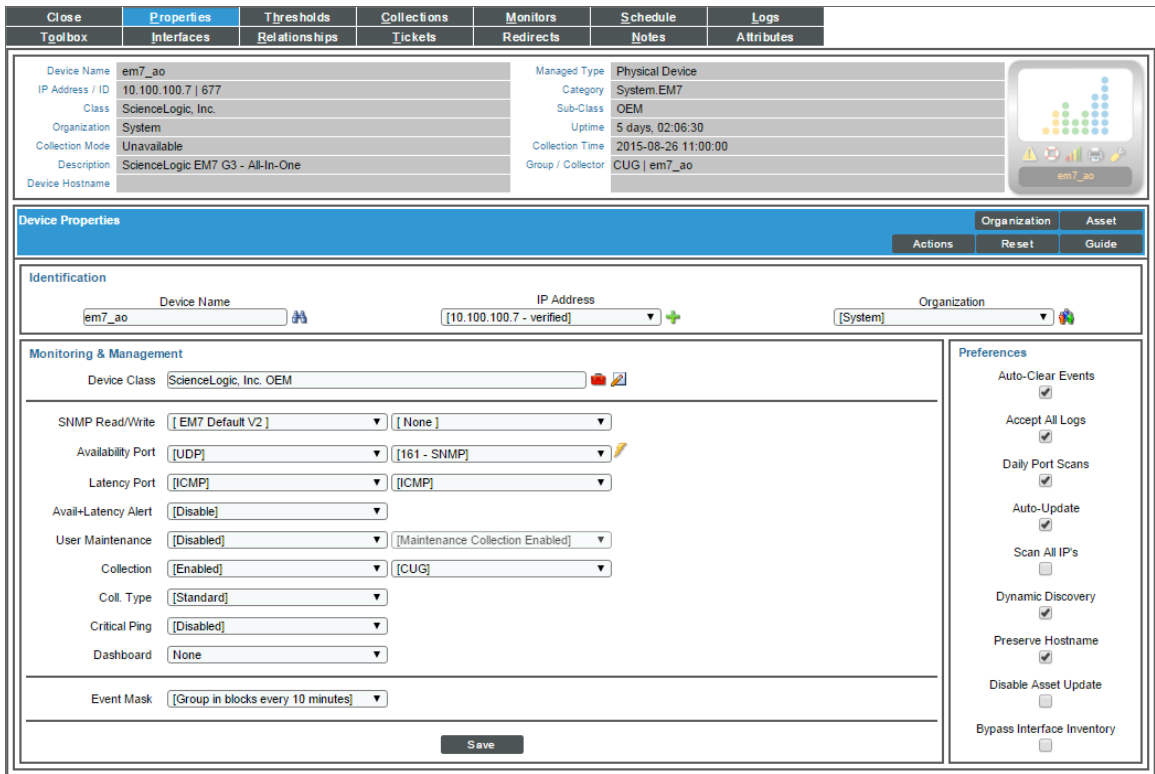

Close	Properties	Thresholds	Collections	Monitors	Schedule	Logs
Toolbox	Interfaces	Relationships	Tickets	Redirects	Notes	Attributes

Device Name	em7_ao	Managed Type	Physical Device
IP Address / ID	10.100.100.7   677	Category	System EM7
Class	ScienceLogic, Inc.	Sub-Class	OEM
Organization	System	Uptime	5 days, 02:06:30
Collection Mode	Unavailable	Collection Time	2015-08-26 11:00:00
Description	ScienceLogic EM7 G3 - All-In-One	Group / Collector	CUG   em7_ao
Device Hostname			

Device Properties		Organization	Asset
		Actions	Reset
			Guide

Identification		
Device Name	em7_ao	IP Address
		[10.100.100.7 - verified]
Organization	[System]	

Monitoring & Management		Preferences
Device Class	ScienceLogic, Inc. OEM	Auto-Clear Events
SNMP Read/Write	[EM7 Default V2] [None]	<input checked="" type="checkbox"/>
Availability Port	[UDP] [161 - SNMP]	Accept All Logs
Latency Port	[ICMP] [ICMP]	<input checked="" type="checkbox"/>
Avail+Latency Alert	[Disable]	Daily Port Scans
User Maintenance	[Disabled] [Maintenance Collection Enabled]	<input checked="" type="checkbox"/>
Collection	[Enabled] [CUG]	Auto-Update
Coll. Type	[Standard]	<input checked="" type="checkbox"/>
Critical Ping	[Disabled]	Scan All IP's
Dashboard	[None]	<input type="checkbox"/>
Event Mask	[Group in blocks every 10 minutes]	Dynamic Discovery
		<input checked="" type="checkbox"/>
		Preserve Hostname
		<input checked="" type="checkbox"/>
		Disable Asset Update
		<input type="checkbox"/>
		Bypass Interface Inventory
		<input type="checkbox"/>

- In the **Device Properties** page, edit the following fields:
  - User Maintenance.** Specifies whether the device is in user maintenance mode. During maintenance mode, for the selected devices SL1 will generate only events with a severity less than the system-wide **Maintenance Minimum Severity** setting. By default, no events are generated during maintenance. You can choose to enable or disable polling during maintenance mode. Even if polling is enabled, SL1 will collect information from the selected devices but will not generate applicable events for the devices. Choices are:
    - Enabled.* Device will be put in user maintenance mode. The device will remain in this state until you or another user disables user maintenance mode.
    - Disabled.* User maintenance mode will be disabled for this device.
  - User Maintenance Collection.** The drop-down list to the right of the **User Maintenance** field specifies whether SL1 will poll the device during user maintenance mode. Choices are:
    - Enabled.* The device will be polled during user maintenance mode.
    - Disabled.* The device will not be polled during user maintenance mode.
- Select the **[Save]** button.

# Enabling and Disabling User Maintenance for One or More Devices

The **Device Manager** page contains a drop-down field in the lower right called **Select Action**. This field allows you to apply an action to multiple devices at once. From the **Select Action** menu, you can enable or disable user maintenance mode for multiple devices, simultaneously.

To enable or disable user maintenance mode for multiple devices:

1. Go to the **Device Manager** page (Devices > Device Manager):

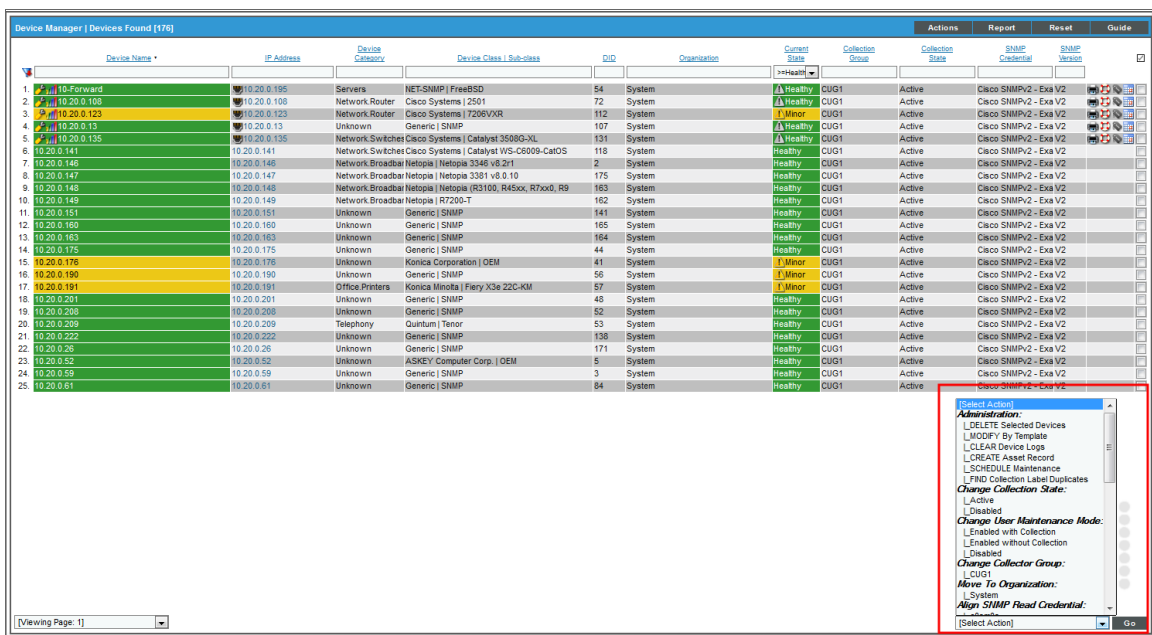

2. In the **Device Manager** page, select the checkbox for each device to which you want to apply the action. To select all checkboxes for all devices, select the red checkbox (☑) at the top of the page.
3. In the **Select Action** drop-down list, select one of the following:
  - **Change User Maintenance Mode: Enabled with Collection.** This option puts the selected devices into user maintenance mode with collection enabled. The devices will remain in this state until you or another user disables user maintenance mode.
  - **Change User Maintenance Mode: Enabled without Collection.** This option puts the selected devices into user maintenance mode with collection disabled. The devices will remain in this state until you or another user disables user maintenance mode.
  - **Change User Maintenance Mode: Disabled.** This option disables user maintenance mode for the selected devices.

4. Click the **[Go]** button.
5. The changes are applied to each selected device.

## Scheduling Maintenance for a Single Device

In the **Schedule Manager** page (in the **Device Administration** panel), you can schedule maintenance and downtime for a device.

**NOTE:** You can also view and manage all scheduled processes from the **Schedule Manager** page (Registry > Schedules > Schedule Manager). For more information, see the **System Administration** manual.

### Viewing the Schedule Manager

The **Schedule Manager** page (Devices > Device Manager > wrench icon > Schedule) displays the following information about each scheduled or recurring device maintenance window:

The screenshot shows the 'Schedule Manager' interface. At the top, there are tabs for 'Close', 'Properties', 'Thresholds', 'Collections', 'Monitors', 'Schedule', 'Logs', 'Toolbox', 'Interfaces', 'Relationships', 'Tickets', 'Redirects', 'Notes', and 'Attributes'. The 'Schedule' tab is active, displaying details for a device with IP 10.2.9.54. Below this, there is a 'Schedule Manager | Schedules Found [2]' section with 'Create' and 'Reset' buttons. A table lists two scheduled events:

	Schedule Summary	Schedule Description	Event ID	sch id	Context	Timezone	Start Time	Duration	Recurrence Interval	End Date	Last Run	Owner	Organization	Visibility	Enabled
1.	Monthly maintenance	Monthly test maintenance	151	80	Devices	America/New_	2017-01-17 03:00:00	80 min	Every 1 Month	2017-12-17 03:00:00	--	banderton	System	Private	Yes
2.	One-time maintenance	One-time test maintenance	152	61	Devices	America/New_	2017-01-20 00:00:00	300 min	--	--	--	banderton	System	Private	Yes

At the bottom right of the table area, there is a '[Select Action]' dropdown menu and a 'Go' button. A copyright notice at the bottom reads: 'Copyright © 2003 - 2017 ScienceLogic, Inc. All rights reserved.'

- **Schedule Summary.** Displays the name assigned to the scheduled process.
- **Schedule Description.** Displays a description of the scheduled process.
- **Event ID.** Displays a unique, numeric ID for the scheduled process. SL1 automatically creates this ID for each scheduled process.
- **sch id.** Displays a unique, numeric ID for the schedule. SL1 automatically creates this ID for each schedule.
- **Context.** Displays the area of SL1 upon which the schedule works.

- **Timezone.** Displays the time zone associated with the scheduled process.
- **Start Time.** Displays the date and time at which the scheduled process will begin.
- **Duration.** Displays the duration, in minutes, which the scheduled process occurs.
- **Recurrence Interval.** If applicable, displays the interval at which the scheduled process recurs.
- **End Date.** If applicable, displays the date and time on which the scheduled process will recur.
- **Last Run.** If applicable, displays the date and time the scheduled process most recently ran.
- **Owner.** Displays the username of the owner of the scheduled process.
- **Organization.** Displays the organization to which the scheduled process is assigned.
- **Visibility.** Displays the visibility level for the scheduled process. Possible values are "Private", "Organization", or "World".
- **Enabled.** Specifies if the scheduled process is enabled. Possible values are "Yes" or "No".

To edit a scheduled or recurring device maintenance window, click its wrench icon (  ) and update the settings as needed on the **Schedule Editor** modal page. (For more information, see the section [Defining a Scheduled or Recurring Device Maintenance Window for a Single Device](#).)

## Defining a Scheduled or Recurring Device Maintenance Window for a Single Device

You can schedule a device maintenance window in SL1 from the **Schedule Manager** page. SL1 will automatically set the status of the device to "maintenance" at the scheduled time.

To define a scheduled or recurring device maintenance window:

1. Go to the **Schedule Manager** page (Devices > Device Manager > wrench icon > Schedule).
2. Click **[Create]**. The **Schedule Editor** modal page appears.
3. On the **Schedule Editor** modal page, enter values in the following fields:

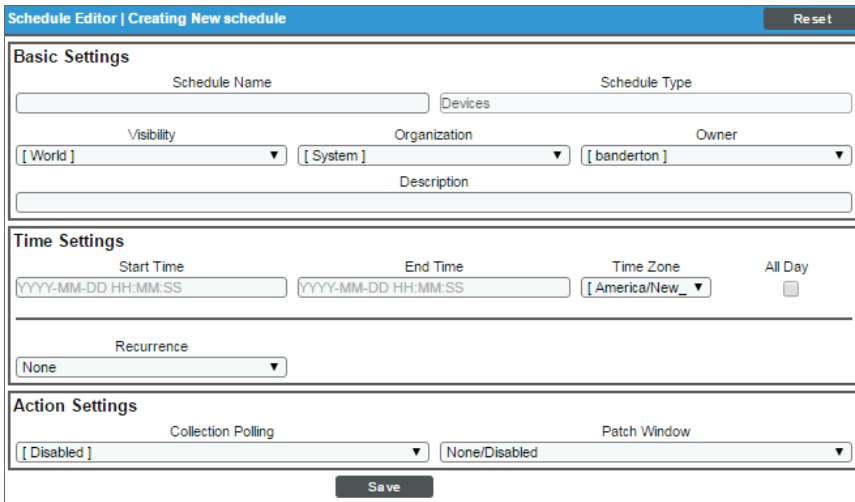

The screenshot shows the 'Schedule Editor | Creating New schedule' modal window. It is divided into three main sections: Basic Settings, Time Settings, and Action Settings. At the top right is a 'Reset' button, and at the bottom center is a 'Save' button.

- Basic Settings:** Includes fields for 'Schedule Name' (empty), 'Schedule Type' (set to 'Devices'), 'Visibility' (set to '[ World ]'), 'Organization' (set to '[ System ]'), 'Owner' (set to '[ banderton ]'), and a 'Description' field (empty).
- Time Settings:** Includes 'Start Time' (format: YYYY-MM-DD HH:MM:SS), 'End Time' (format: YYYY-MM-DD HH:MM:SS), 'Time Zone' (set to '[ America/New\_ ]'), and an 'All Day' checkbox (unchecked). Below these is a 'Recurrence' dropdown menu set to 'None'.
- Action Settings:** Includes 'Collection Polling' (set to '[ Disabled ]') and 'Patch Window' (set to 'None/Disabled').

## **Basic Settings**

- **Schedule Name.** Type a name for the scheduled process.
- **Schedule Type.** Indicates the scheduled process type (such as Tickets, Reports, or Devices).
- **Visibility.** Select the visibility for the scheduled process. You can select one of the following:
  - *Private.* The scheduled process is visible only to the owner selected in the **Owner** field.
  - *Organization.* The scheduled process is visible only to the organization selected in the **Organization** field.
  - *World.* The scheduled process is visible to all users.
- **Organization.** Select the organization to which you want to assign the scheduled process.
- **Owner.** Select the owner of the scheduled process. The default value is the username of the user who created the scheduled process.
- **Description.** Type a description of the scheduled process.

## **Time Settings**

- **Start Time.** Click in the field and select the date and time you want the scheduled process to start.
- **End Time.** Click in the field and select the date and time you want the scheduled process to end.
- **Time Zone.** Select the region or time zone for the scheduled start time.

**NOTE:** If you want SL1 to automatically adjust for daylight savings time (if applicable), then you must select a named region (such as *America/New York*) in the **Time Zone** field. If you select a specific time zone (such as *EST*) or a specific time offset (such as *GMT-5*), then SL1 will not automatically adjust for daylight savings time.

- **All Day.** Select this checkbox if the scheduled process occurs all day rather than during a specific period of time. If you do so, the **End Time** field becomes disabled.
- **Recurrence.** Select whether you want the scheduled process to occur once or on a recurring basis. You can select one of the following:
  - *None.* The scheduled process occurs only once.
  - *By Interval.* The scheduled process recurs at a specific interval.

If you select *By Interval*, the following additional fields appear:

- **Interval.** In the first field, enter a number representing the frequency of the scheduled process, then select the time interval in the second field. Choices are *Minutes*, *Hours*, *Days*, *Weeks*, or *Months*. For example:
  - If you specify "6 Hours", then the scheduled process recurs every six hours from the time listed in the **Start Time** field.



- If you specify "10 Days", then the scheduled process recurs every 10 days from the date listed in the **Start Time** field.
- If you specify "2 Weeks", then the scheduled process recurs every two weeks, on the same day of the week as the **Start Time**.
- If you specify "3 Months" the ticket recurs every three months, on the same day of the month as the **Start Time**.
- **Recur Until**. Specifies when the scheduled process stops recurring. You can select one of the following:
  - *No Limit*. The scheduled process recurs indefinitely until it is disabled.
  - *Specified Date*. The scheduled process recurs until a specific date and time. If you select *Specified Date*, you must select a date and time in the **Last Recurrence** field.
- **Last Recurrence**. Click in the field and select the date and time you want the scheduled process to stop recurring.

### **Action Settings**

- **Collection Polling**. Specifies whether SL1 should perform collection on the device during the scheduled maintenance. Choices are:
  - *Enabled*. During scheduled maintenance, SL1 will collect data from the device, but no events will be triggered for the device.
  - *Disabled*. During scheduled maintenance, SL1 will not collect data from the device. No events will be triggered for the device.
- **Patch Window**. You can specify a "patch window" within the larger maintenance period. The "patch window" allows SL1 to limit the suppression of events to a small time-frame within the larger maintenance window. Your choices are:
  - *None*
  - *Between 5 minutes and 60 minutes*, in five-minute intervals.

For example:

Suppose you have to apply a patch to a server that is monitored by SL1. Suppose you know you will perform this task sometime between midnight and 6:00 AM. Suppose you know that the actual patch process requires only 15 minutes of downtime for the server. In SL1, you would define a maintenance window of 24:00 - 6:00 and a patch window of 15 minutes. In this scenario:

1. At 24:00, SL1 generates an event saying that the server is going into maintenance mode. Because you have defined a patch window, SL1 continues to monitor this server as normal.
2. At 3:00, you apply the patch to the server. The server reboots, and SL1 generates an event saying that the server is offline. The first event that both matches or exceeds the **Patch Maintenance Minimum Severity** in the **Behavior Settings** page (System > Settings > Behavior) and occurs within the larger maintenance window triggers the start of the patch window.

3. SL1 suppresses the event that triggered the patch maintenance window and instead generates an event "Patch Maintenance Window Opened".
4. For the next 15 minutes, SL1 will suppress all events for the device.
5. At 3:15, SL1 will generate an event for "Patch Maintenance Window Closed". This event clears the previous event "Patch Maintenance Window Opened".
6. SL1 will now generate events for the device, even though the maintenance window extends until 6:00.

**NOTE:** If the patch was applied at 5:50, the server was rebooted, and SL1 generated an event saying that the server is offline, events would be suppressed only until the end of the maintenance window, 6:00, even though the patch window is 15 minutes.

4. Click [Save].

## Scheduling Maintenance for One or More Devices

The **Device Manager** page contains a drop-down field in the lower right called **Select Action**. This field allows you to apply an action to multiple devices at once. From the **Select Action** menu, you can schedule maintenance for multiple devices, simultaneously.

To schedule maintenance for multiple devices:

1. Go to the **Device Manager** page (Devices > Device Manager):

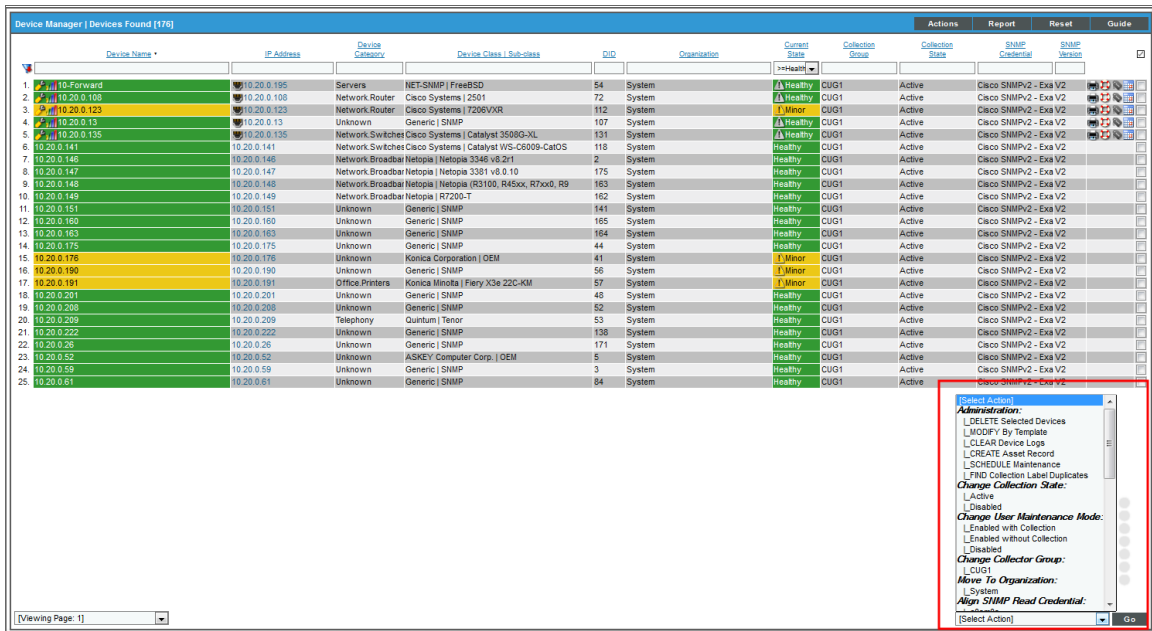

2. In the **Device Manager** page, select the checkbox for each device for which you want to schedule maintenance. To select all checkboxes for all devices, select the red checkbox (☑) at the top of the page.
3. In the **Select Action** drop-down list, select *Schedule Maintenance*, and then click **[Go]**. The **Schedule Editor** modal page appears.
4. To schedule maintenance for the selected devices, follow the steps described in the section [Defining a Scheduled or Recurring Device Maintenance Window for a Single Device](#). The values you supply in the **Schedule Editor** modal page are applied to each selected device.

## Enabling or Disabling Scheduled Maintenance for One or More Devices

You can enable or disable one or more scheduled or recurring device maintenance windows from the **Schedule Manager** page (Devices > Device Manager > wrench icon > Schedule). To do this:

1. Go to the **Schedule Manager** page (Devices > Device Manager > wrench icon > Schedule).

The screenshot shows the 'Schedule Manager' interface. At the top, there are tabs for 'Close', 'Properties', 'Thresholds', 'Collections', 'Monitors', 'Schedule', 'Notes', and 'Attributes'. Below these are sub-tabs for 'Logs', 'Toolbox', 'Interfaces', 'Relationships', 'Tickets', 'Redirects', and 'Attributes'. The main content area displays a table of scheduled maintenance events. The table has columns for 'Schedule Summary', 'Schedule Description', 'Event ID', 'sch. id', 'Context', 'Timezone', 'Start Time', 'Duration', 'Recurrence Interval', 'End Date', 'Last Run', 'Owner', 'Organization', 'Visibility', and 'Enabled'. Two events are listed: 'Monthly maintain' and 'One-time maintain'. A red box highlights the 'Select Action' dropdown menu, which is open to show options: '\_DELETE Schedules', '\_ENABLE Schedules', and '\_DISABLE Schedules'. The 'Go' button is also visible next to the dropdown.

Schedule Summary	Schedule Description	Event ID	sch. id	Context	Timezone	Start Time	Duration	Recurrence Interval	End Date	Last Run	Owner	Organization	Visibility	Enabled
1. Monthly maintain	Monthly test maintenar	151	60	Devices	America/New_	2017-01-17 03:00:00	80 min	Every 1 Month	2017-12-17 03:00:00	--	banderton	System	Private Yes	<input checked="" type="checkbox"/>
2. One-time maintain	One-time test mainten	152	61	Devices	America/New_	2017-01-20 00:00:00	300 min	--	--	--	banderton	System	Private Yes	<input type="checkbox"/>

2. Select the checkbox icon for each scheduled process you want to enable or disable.
3. Click the **Select Action** menu and choose *Enable Schedules* or *Disable Schedules*.
4. Click the **[Go]** button.

# Deleting Scheduled Maintenance for One or More Devices

You can delete one or more scheduled or recurring device maintenance windows from the **Schedule Manager** page (Devices > Device Manager > wrench icon > Schedule).

To delete maintenance windows:

1. Go to the **Schedule Manager** page (Devices > Device Manager > wrench icon > Schedule).

The screenshot shows the 'Schedule Manager' interface. At the top, there are tabs for 'Close', 'Properties', 'Thresholds', 'Collections', 'Monitors', 'Schedule', 'Logs', 'Toolbox', 'Interfaces', 'Relationships', 'Tickets', 'Redirects', 'Notes', and 'Attributes'. The 'Schedule' tab is active. Below the tabs, there are fields for 'Device Name', 'IP Address / ID', 'Class', 'Organization', 'Collection Mode', 'Description', and 'Device Hostname'. To the right, there are fields for 'Managed Type', 'Category', 'Sub-Class', 'Uptime', 'Collection Time', and 'Group / Collector'. A 'Ping Device' button is visible on the right side. Below these fields, there is a 'Schedule Manager | Schedules Found [2]' section with 'Create' and 'Reset' buttons. A table lists the schedules:

	Schedule Summary	Schedule Description	Event ID	sch. id	Context	Timezone	Start Time	Duration	Recurrence Interval	End Date	Last Run	Owner	Organization	Visibility	Enabled
1.	Monthly maintain	Monthly test mainten	151	80	Devices	America/New_	2017-01-17 03:00:00	80 min	Every 1 Month	2017-12-17 03:00:00	--	banderton	System	Private	Yes
2.	One-time maintain	One-time test maintent	152	81	Devices	America/New_	2017-01-20 00:00:00	300 min	--	--	--	banderton	System	Private	Yes

At the bottom right, a dropdown menu is open, showing options: '[Select Action]', '[Select Action]', 'Administration:', 'DELETE Schedules', 'ENABLE Schedules', and 'DISABLE Schedules'. A 'Go' button is next to the dropdown. The 'DELETE Schedules' option is highlighted.

2. Select the checkbox icon for each scheduled process you want to delete.
3. Click the **Select Action** menu and choose *Delete Schedules*.
4. Click the **[Go]** button.

---

# Chapter

# 10



## Managing Dynamic Applications

---

### Overview

This chapter describes how to manage the Dynamic Applications aligned to a device.

Use the following menu options to navigate the SL1 user interface:

- To view a pop-out list of menu options, click the menu icon ().
- To view a page containing all of the menu options, click the Advanced menu icon ().

This chapter includes the following topics:

<b>Viewing the List of All Dynamic Applications in SL1</b> .....	<b>214</b>
<i>Searching and Filtering the List of Dynamic Applications</i> .....	218
<i>Special Characters</i> .....	220
<b>Managing the Dynamic Applications Aligned to a Device</b> .....	<b>223</b>
<i>Viewing the List of Dynamic Applications Aligned to a Device</i> .....	224
<i>Viewing Information about a Dynamic Application Aligned to a Device</i> .....	225
<i>Changing the Credential for a Dynamic Application Aligned to a Device</i> .....	226
<i>Updating the Poll Frequency for a Dynamic Application Aligned to a Device</i> .....	226
<i>Manually Aligning a Dynamic Application to a Device</i> .....	227
<i>Viewing the Status of a Dynamic Application Aligned to a Device</i> .....	228
<i>Understanding the Found Status</i> .....	228
<i>Understanding the Collecting Status</i> .....	229
<i>Enabling and Disabling Dynamic Application Data Collection for a Device</i> .....	229
<i>Enabling and Disabling Collection for Specific Collection Objects</i> .....	229

<i>Running a Dynamic Application on a Device</i> .....	230
<b>Managing the Dynamic Applications Associated with a Device in the Classic SL1 User Interface</b> .....	<b>230</b>
<i>Viewing the Dynamic Applications Associated with a Device in the Classic SL1 User Interface</i> .....	230
<i>Manually Associating a Dynamic Application with a Device in the Classic SL1 User Interface</i> .....	232
<i>Editing the Credential Associated with a Dynamic Application in the Classic SL1 User Interface</i> .....	234
<i>Viewing the Status of a Dynamic Application Associated with a Device in the Classic SL1 User Interface</i> ...	235
Found .....	236
Collect .....	236
<i>Performing Other Administrative Tasks for an Aligned Dynamic Application in the Classic SL1 User Interface</i> .....	237
Enabling or Disabling Objects .....	237
Restarting Automatic Maintenance of Collection Objects .....	238
Editing the Poll Frequency for a Dynamic Application on the Current Device .....	238
Stopping Data Collection for a Dynamic Application .....	239
Resetting Statistical Data for a Dynamic Application .....	239
Resetting Persistent Session Objects for a Dynamic Application .....	240
Testing Data Collection for a Dynamic Application .....	241
Removing Data Collected by a Dynamic Application .....	241
<b>How SL1 Manages the Collection Status for Dynamic Applications</b> .....	<b>242</b>
<i>Stopping Collection</i> .....	242
<i>Starting Collection</i> .....	243
<i>Collection Objects that are Excluded from Maintenance</i> .....	243
<b>Status of Objects for Deviation</b> .....	<b>243</b>
<b>Bulk Un-Aligning Dynamic Applications</b> .....	<b>244</b>
<b>Setting Thresholds for Dynamic Applications</b> .....	<b>245</b>
<b>Dynamic Applications and Discovery</b> .....	<b>246</b>
<i>How Does SL1 Align Dynamic Applications During Discovery?</i> .....	246
<i>Queuing Discovery from the Dynamic Applications Manager Page</i> .....	247

---

## Viewing the List of All Dynamic Applications in SL1

The **Dynamic Applications Manager** page (System > Manage > Dynamic Applications) displays a list of all existing Dynamic Applications. For each Dynamic Application, the page displays the following:

Dynamic Applications Manager   Total Found [1545]														Actions	Reset	Guide
Dynamic Application Name	Poll Rate	Type	State	Version	ID	Subscribers	PowerPack	Environment	Collects	Alerts	Events	Thresh	Edited By	Last Edit		
1. Not Test ICDA	1 min.	Snippet Configuration	Enabled	1	1502	--	ScienceLogic: ICDA Har...	SYSTEM	1	--	--	--	em7admin	2018-07-20 09:27:05		
2. 2-level DCM app cache producer	15 min.	Snippet Configuration	Enabled	0.1	1517	--	2-level DCM app test	SYSTEM	1	--	--	--	em7admin	2018-07-20 09:26:21		
3. 2-level DCM app config	1 min.	Snippet Configuration	Enabled	0.1	1520	--	2-level DCM app test	SYSTEM	1	1	1	--	em7admin	2018-07-20 09:26:21		
4. 2-level DCM app level1 discovery	1 min.	Snippet Configuration	Enabled	0.1	1518	--	2-level DCM app test	SYSTEM	2	--	--	--	em7admin	2018-07-20 09:26:21		
5. 2-level DCM app level2 discovery	1 min.	Snippet Configuration	Enabled	0.1	1519	--	2-level DCM app test	SYSTEM	2	--	--	--	em7admin	2018-07-20 09:26:21		
6. Alteon: Configuration	120 min.	SNMP Configuration	Enabled	1.2	1174	--	Alteon Base Pack	n/a	30	5	5	--	em7admin	2018-07-19 23:27:21		
7. Alteon: Load Trending	15 min.	SNMP Performance	Enabled	1.1	1173	--	Alteon Base Pack	n/a	8	--	--	--	em7admin	2018-07-19 23:27:21		
8. Alteon: Performance	15 min.	SNMP Performance	Enabled	2.7	1175	--	Alteon Base Pack	n/a	6	--	--	--	em7admin	2018-07-19 23:27:22		
9. APC: Environmental T/H	5 min.	SNMP Performance	Enabled	6.1	713	--	APC Base Pack	n/a	3	2	2	1	em7admin	2018-07-19 23:24:41		
10. APC: Asset Tracking	1440 min.	SNMP Configuration	Enabled	1.1	707	--	APC Base Pack	n/a	11	--	--	--	em7admin	2018-07-19 23:24:41		
11. APC: Battery Performance	15 min.	SNMP Performance	Enabled	1.1	708	--	APC Base Pack	n/a	7	--	--	--	em7admin	2018-07-19 23:24:41		
12. APC: Battery Status	15 min.	SNMP Configuration	Enabled	1.2	709	--	APC Base Pack	n/a	9	12	12	2	em7admin	2018-07-19 23:24:41		
13. APC: Configuration	360 min.	SNMP Configuration	Enabled	1.1	710	--	APC Base Pack	n/a	20	4	4	--	em7admin	2018-07-19 23:24:41		
14. APC: Environmental Asset	1440 min.	SNMP Configuration	Enabled	6.1	714	--	APC Base Pack	n/a	12	--	--	--	em7admin	2018-07-19 23:24:41		
15. APC: PDU Performance	15 min.	SNMP Performance	Enabled	1.3	712	--	APC Base Pack	n/a	3	--	--	--	em7admin	2018-07-19 23:24:41		
16. APC: SmartUPS Power Output	5 min.	SNMP Performance	Enabled	6.1	715	--	APC Base Pack	n/a	2	--	--	--	em7admin	2018-07-19 23:24:42		
17. APC: UPS Testing	1440 min.	SNMP Configuration	Enabled	1.2	711	--	APC Base Pack	n/a	6	9	9	--	em7admin	2018-07-19 23:24:41		
18. Aruba: Asset	1440 min.	SNMP Configuration	Enabled	2.8	1434	--	Aruba Base Pack	n/a	18	--	--	--	em7admin	2018-07-19 23:28:45		
19. Aruba: Voice Counters	5 min.	SNMP Performance	Enabled	2.8	1435	--	Aruba Base Pack	n/a	15	--	--	--	em7admin	2018-07-19 23:28:45		

**TIP:** To sort the list of Dynamic Applications, click on a column heading. The list will be sorted by the column value, in ascending order. To sort by descending order, click the column heading again. The **Last Edit** column sorts by descending order on the first click; to sort by ascending order, click the column heading again.

**NOTE:** By default, the cursor is placed in the first Filter-While-You-Type field. You can use the <Tab> key or your mouse to move your cursor through the fields.

- **Dynamic Application Name.** Name of the Dynamic Application, as defined in the **Dynamic Applications Properties Editor** page.
- **Poll Rate.** Frequency, in minutes, at which SL1 will poll all devices that use this Dynamic Application.





**NOTE:** The **Poll Rate** column displays the default poll frequency for the Dynamic Application, as defined in the **Dynamic Applications Properties Editor** page. You can define a **custom** poll frequency for one or more devices in a device template. The poll frequency defined in the device template overrides the poll frequency defined for the Dynamic Application. Devices to which the device template is applied will use the poll frequency defined in the device template.

- **Type.** Type of Dynamic Application. The choices are:
  - **Bulk Snippet Configuration.** A single instance of the Dynamic Application uses custom-written Python code to collect static configuration data from *multiple* devices. This is useful for systems that include a large number of component devices. For details on creating bulk snippet Dynamic Applications, see the **Snippet Dynamic Application Development** manual.

- *Bulk Snippet Performance*. A single instance of the Dynamic Application uses custom-written Python code to collect trendable performance data from *multiple devices*. This is useful for systems that include a large number of component devices. For details on creating bulk snippet Dynamic Applications, see the **Snippet Dynamic Application Development** manual.
- *Database Configuration*. The Dynamic Application retrieves configuration data from a database application. The Dynamic Application uses SQL queries. The queried device returns table data. For details on creating database Dynamic Applications, see the **Database Dynamic Application Development** manual.
- *Database Performance*. The Dynamic Application retrieves trendable performance data from a database application. The Dynamic Application uses SQL queries. The queried device returns table data. For details on creating database Dynamic Applications, see the **Database Dynamic Application Development** manual.
- *Internal Collection Inventory*. The Internal Collection Inventory Dynamic Application (ICDA) retrieves configuration data about filesystems and interface. For filesystem, an ICDA Inventory can retrieve data such as storage size, filesystem type, and storage used. These ICDA's can also collect configuration data about interfaces, such as physical address, operational status, and IP addresses. For details on creating ICDA's, see the **Internal Collection Dynamic Application Development** manual.
- *Internal Collection Performance*. The Internal Collection Performance Dynamic Application (ICDA) retrieves data about availability and latency, device information (system description, system uptime, system locale), filesystem performance, and interface performance. For details on creating ICDA's, see the **Internal Collection Dynamic Application Development** manual.
- *IT Service*. A special type of Dynamic Application that SL1 uses to monitor IT Services. When you create and edit an IT Service in the **IT Service Editor** page, SL1 will automatically create and maintain a Dynamic Application for that IT Service. Dynamic Applications for IT Services will appear in the **Dynamic Applications Manager** page. However, if you want to edit the settings for an IT Service, you should not edit the Dynamic Application for that IT Service. Instead, use the **IT Service Editor** page to edit IT Services. For details on creating IT Service policies, see the manual **IT Services**.
- *PowerShell Configuration*. The Dynamic Application uses PowerShell commands to collect static configuration data from a Windows device. For details on creating PowerShell Dynamic Applications, see the manual **Dynamic Application Development - WMI and PowerShell**. For information on configuring SL1 and external systems to use PowerShell Dynamic Applications, see the manual **Monitoring Windows Systems with PowerShell** and **Monitoring Windows Systems with WMI**.
- *PowerShell Performance*. The Dynamic Application uses PowerShell commands to collect trendable performance data from a Windows device. For details on creating PowerShell Dynamic Applications, see the manual **Dynamic Application Development - WMI and PowerShell**. For information on configuring SL1 and external systems to use PowerShell Dynamic Applications, see the manual **Monitoring Windows Systems with PowerShell** and **Monitoring Windows Systems with WMI**.
- *Snippet Configuration*. The Dynamic Application uses custom-written Python code to collect configuration data from a device. For details on creating snippet Dynamic Applications, see the **Snippet Dynamic Application Development** manual.
- *Snippet Journal*. The Dynamic Application uses custom-written Python code to collect data formatted as log entries from a device. For details on creating snippet Dynamic Applications, see the **Snippet Dynamic Application Development** manual.



- *Snippet Performance*. The Dynamic Application uses custom-written Python code to collect trendable performance data from a device. For details on creating snippet Dynamic Applications, see the **Snippet Dynamic Application Development** manual.
- *SNMP Configuration*. The Dynamic Application uses SNMP to retrieve static, configuration data from devices or applications. For details on creating SNMP Dynamic Applications, see the **SNMP Dynamic Application Development** manual.
- *SNMP Performance*. The Dynamic Application uses SNMP to retrieve trendable performance data from devices or applications. For details on creating SNMP Dynamic Applications, see the **SNMP Dynamic Application Development** manual.
- *SOAP Configuration*. The Dynamic Application uses XML and SOAP to retrieve static configuration data from a SOAP server. The queried device returns XML data. For details on creating SOAP Dynamic Applications, see the **XML, SOAP, and XSLT Dynamic Application Development** manual.
- *SOAP Performance*. The Dynamic Application uses XML and SOAP to retrieve trendable performance data from a SOAP server. The queried device returns XML data. For details on creating SOAP Dynamic Applications, see the **XML, SOAP, and XSLT Dynamic Application Development** manual.
- *WMI Configuration*. The Dynamic Application retrieves configuration information from either WMI or WBEM running on a managed device. WMI Dynamic Applications use a query format to request data from a managed device. WBEM Dynamic Applications use wbemcli and HTTP to request data from a managed device. For details on creating WMI Dynamic Applications, see the manual **Dynamic Application Development - WMI and PowerShell**. For information on configuring SL1 and external systems to use PowerShell Dynamic Applications, see the manual **Monitoring Windows Systems with PowerShell** and **Monitoring Windows Systems with WMI**.
- *WMI Performance*. The Dynamic Application retrieves trendable performance data from either WMI or WBEM running on a managed device. WMI Dynamic Applications use a query format to request data from a managed device. WBEM Dynamic Applications use wbemcli and HTTP to request data from a managed device.
- *XML Configuration*. The Dynamic Application uses HTTP GET queries. The queried device returns static configuration data in XML format. For details on creating SOAP Dynamic Applications, see the **XML, SOAP, and XSLT Dynamic Application Development** manual.
- *XML Performance*. The Dynamic Application uses HTTP GET queries. The queried device returns trendable performance data in XML format. For details on creating SOAP Dynamic Applications, see the **XML, SOAP, and XSLT Dynamic Application Development** manual.
- *XSLT Configuration*. The Dynamic Application uses XML and SOAP to retrieve static configuration data from a SOAP server. The requests used to retrieve data are generated by performing an XSLT transformation on an XML document that contains data already collected by the Dynamic Application. The queried device returns XML data, which must be changed to a specific format by performing a second XSLT transformation. For details on creating SOAP Dynamic Applications, see the **XML, SOAP, and XSLT Dynamic Application Development** manual.
- *XSLT Performance*. The Dynamic Application uses XML and SOAP to retrieve trendable performance data from a SOAP server. The requests used to retrieve data are generated by performing an XSLT transformation on an XML document that contains data already collected by the Dynamic Application. The queried device returns XML data, which must be changed to a specific format by performing a second XSLT transformation. For details on creating SOAP Dynamic Applications, see the **XML, SOAP, and XSLT Dynamic Application Development** manual.

- **State**. Specifies whether the Dynamic Application is *Enabled* or *Disabled*.
- **Version**. Version number to assign to the Dynamic Application. You can customize this value and increment it according to your change-management policies.
- **ID**. Unique application ID, assigned by SL1.
- **Subscribers**. Number of devices that use the Dynamic Application. Clicking on the icon leads to the **Application Subscribers** modal page, where you can view the list of devices and access other pages for each subscriber device. You can also access this page by selecting the wrench icon () for a Dynamic Application and selecting the **[Subscribers]** tab.
- **PowerPack**. Specifies whether or not the Dynamic Application is included in a PowerPack.
- **Environment**. The execution environment to which the Dynamic Application is aligned, if it is a snippet or internal collection Dynamic Application. If it is not a snippet or internal collection Dynamic Application, then this column displays "n/a".
- **Collects**. Number of objects included in the Dynamic Application. Clicking on the icon () leads to the **Collection Objects** page, where you can view the list of collection objects and edit their properties.
- **Alerts**. Number of custom alerts defined for the Dynamic Application. Clicking on the icon () leads to the **Alert Objects** page, where you can view and edit each alert defined for the Dynamic Application.
- **Events**. Number of events associated with the Dynamic Application. Clicking on the icon () leads to the **Event Policy Manager** page, where you can view information about each event definition associated with the Dynamic Application definition and edit each event definition.
- **Thresh**. Number of threshold objects defined for the Dynamic Application. Clicking on the icon () leads to the **Threshold Objects** page, where you can view and edit information about each threshold object defined for the Dynamic Application.
- **Edited By**. Username of the person who created or last edited the Dynamic Application.
- **Last Edit**. Date that the Dynamic Application was created or last edited.

## Searching and Filtering the List of Dynamic Applications

The Filter-While-You-Type fields appear as a row of blank fields at the top of the list. These fields allow you to filter the items that appear in the list.

The list is dynamically updated as you select each filter. For each filter, you must make a selection from a drop-down menu or type text to match against. SL1 will search for entries that match the text, including partial matches. Text matches are not case-sensitive, and you can use special characters in each text field.

By default, the cursor is placed in the first Filter-While-You-Type field. You can use the <Tab> key or your mouse to move your cursor through the fields.

You can filter by one or more of the following parameters. Only items that meet all of the filter criteria are displayed on the page.

- **Dynamic Application Name**. You can enter text to match, including *special characters*, and the Dynamic Applications Manager page will display only Dynamic Applications that have a matching name.

- **Poll Rate.** You can enter text to match, including *special characters*, and the Dynamic Applications Manager page will display only Dynamic Applications that have a matching polling rate.
- **Type.** You can enter text to match, including *special characters*, , and the Dynamic Applications Manager page will display only Dynamic Applications that have a matching type.
- **State.** You can enter text to match, including *special characters*, and the Dynamic Applications Manager page will display only Dynamic Applications that have a matching state.
- **Version.** You can enter text to match, including *special characters*, and the Dynamic Applications Manager page will display only Dynamic Applications that have a matching version number.
- **ID.** You can enter text to match, including *special characters*, and the Dynamic Applications Manager page will display only Dynamic Applications that have a matching ID number.
- **Subscribers.** You can enter text to match, including *special characters*, and the Dynamic Applications Manager page will display only Dynamic Applications that have a matching number of subscribers.
- **PowerPack.** You can enter text to match, including *special characters*, and the Dynamic Applications Manager page will display only Dynamic Applications that have a matching PowerPack.
- **Environment.** You can enter text to match, including *special characters*, and the Dynamic Applications Manager page will display only Dynamic Applications that have a matching execution environment.
- **Collects.** You can enter text to match, including *special characters*, and the Dynamic Applications Manager page will display only Dynamic Applications that have a matching number of collection objects.
- **Alerts.** You can enter text to match, including *special characters*, and the Dynamic Applications Manager page will display only Dynamic Applications that have a matching number of alerts.
- **Events.** You can enter text to match, including *special characters*, and the Dynamic Applications Manager page will display only Dynamic Applications that have a matching number of event policies.
- **Thresh.** You can enter text to match, including *special characters*, and the Dynamic Applications Manager page will display only Dynamic Applications that have a matching number of thresholds.
- **Edited By.** You can enter text to match, including *special characters*, and the Dynamic Applications Manager page will display only Dynamic Applications that were created or edited by a a matching user-name.
- **Last Edited.** Only those Dynamic Applications that match all the previously selected fields and have the specified "last edited" date will be displayed. The choices are:
  - *All.* Display all Dynamic Applications that match the other filters.
  - *Last Minute.* Display only Dynamic Applications that have been modified within the last minute.
  - *Last Hour.* Display only Dynamic Applications that have been modified within the last hour.
  - *Last Day.* Display only Dynamic Applications that have been modified within the last day.
  - *Last Week.* Display only Dynamic Applications that have been modified within the last week.
  - *Last Month.* Display only Dynamic Applications that have been modified within the last month.
  - *Last Year.* Display only Dynamic Applications that have been modified within the last year.

## Special Characters

You can include the following special characters to filter by each column except those that display date and time:

**NOTE:** When searching for a string, SL1 will match substrings by default, even if you do not include any special characters. For example, searching for "hel" will match both "hello" and "helicopter". When searching for a numeric value, SL1 will not match a substring unless you use a special character.

### String and Numeric

- , (comma). Specifies an "OR" operation. Works for string and numeric values. For example:  
"dell, micro" matches all values that contain the string "dell" OR the string "micro".
- & (ampersand). Specifies an "AND" operation. Works for string and numeric values. For example:  
"dell & micro" matches all values that contain both the string "dell" AND the string "micro", in any order.
- ! (exclamation point). Specifies a "not" operation. Works for string and numeric values. For example:  
"!dell" matches all values that do not contain the string "dell".  
"!^ micro" would match all values that do not start with "micro".  
"!fer\$" would match all values that do not end with "fer".  
"!^ \$" would match all values that are not null.  
"!^" would match null values.  
"!\$" would match null values.  
"!\*" would match null values.  
"happy, !dell" would match values that contain "happy" OR values that do not contain "dell".

**NOTE:** You can also use the "!" character in combination with the arithmetic special characters (min-max, >, <, >=, <=, =) described below.

- \* (asterisk). Specifies a "match zero or more" operation. Works for string and numeric values. For a string, matches any string that matches the text before and after the asterisk. For a number, matches any number that contains the text. For example:

"hel\*er" would match "helpers" and "helicopter" but not "hello".

"325\*" would match "325", "32561", and "325000".

"\*000" would match "1000", "25000", and "10500000".

- ? (question mark). Specifies "match any one character". Works for string and numeric values. For example:

"l?ver" would match the strings "oliver", "levers", and "lover", but not "believer".

"135?" would match the numbers "1350", "1354", and "1359", but not "135" or "13502"

### String

- ^ (caret). For strings only. Specifies "match the beginning". Matches any string that begins with the specified string. For example:

"^sci" would match "scientific" and "sciencelogic", but not "conscious".

"^happy\$" would match only the string "happy", with no characters before or after.

"!^micro" would match all values that do not start with "micro".

"!^\$" would match all values that are not null.

"!^" would match null values.

- \$ (dollar sign). For strings only. Specifies "match the ending". Matches any string that ends with the specified string. For example:

"ter\$" would match the string "renter" but not the string "terrific".

"^happy\$" would match only the string "happy", with no characters before or after.

"!fer\$" would match all values that do not end with "fer".

"!^\$" would match all values that are not null.

"!\$" would match null values.

**NOTE:** You can use both ^ and \$ if you want to match an entire string and only that string. For example, "^tern\$" would match the strings "tern" or "Tern" or "TERN"; it would not match the strings "terne" or "cistern".

## Numeric

- min-max. Matches numeric values only. Specifies any value between the minimum value and the maximum value, including the minimum and the maximum. For example:

"1-5" would match 1, 2, 3, 4, and 5.

- - (dash). Matches numeric values only. A "half open" range. Specifies values including the minimum and greater or including the maximum and lesser. For example:

"1-" matches 1 and greater. So would match 1, 2, 6, 345, etc.

"-5" matches 5 and less. So would match 5, 3, 1, 0, etc.

- > (greater than). Matches numeric values only. Specifies any value "greater than". For example:

">7" would match all values greater than 7.

- < (less than). Matches numeric values only. Specifies any value "less than". For example:

"<12" would match all values less than 12.

- >= (greater than or equal to). Matches numeric values only. Specifies any value "greater than or equal to". For example:

">=7" would match all values 7 and greater.

- <= (less than or equal to). Matches numeric values only. Specifies any value "less than or equal to". For example:

"<=12" would match all values 12 and less.

- = (equal). Matches numeric values only. For numeric values, allows you to match a negative value. For example:

"=-5" would match "-5" instead of being evaluated as the "half open range" as described above.

## Additional Examples

- "aio\$". Matches only text that ends with "aio".
- "^shu". Matches only text that begins with "shu".
- "^silo\$". Matches only the text "silo", with no characters before or after.
- "!silo". Matches only text that does not contain the characters "silo".
- "!^silo". Matches only text that does not start with "silo".
- "!O\$". Matches only text that does not end with "O".
- "!^silo\$". Matches only text that is not the exact text "silo", with no characters before or after.
- "!. Matches null values, typically represented as "--" in most pages.
- "!. Matches null values, typically represented as "--" in most pages.

- "!"^\$. Matches all text that is not null.
- silo, !aggr". Matches text that contains the characters "silo" and also text that does not contain "aggr".
- "silo, 02, !aggr". Matches text that contains "silo" and also text that contains "02" and also text that does not contain "aggr".
- "silo, 02, !aggr, !01". Matches text that contains "silo" and also text that contains "02" and also text that does not contain "aggr" and also text that does not contain "01".
- "^s\*i!\*o\$". Matches text that contains the letter "s", "i", "l", "o", in that order. Other letters might lie between these letters. For example "sXiXlXo" would match.
- "!^s\*i!\*o\$". Matches all text that does not that contains the letter "s", "i", "l", "o", in that order. Other letters might lie between these letters. For example "sXiXlXo" would not match.
- "!vol&!silo". Matches text that does not contain "vol" AND also does not contain "silo". For example, "volume" would match, because it contains "vol" but not "silo".
- "!vol&02". Matches text that does not contain "vol" AND also contains "02". For example, "happy02" would match, because it does not contain "vol" and it does contain "02".
- "aggr, !vol&02". Matches text that contains "aggr" OR text that does not contain "vol" AND also contains "02".
- "aggr, !vol&!infra". Matches text that contains "aggr" OR text that does not contain "vol" AND does not contain "infra".
- "\*". Matches all text.
- "!\*". Matches null values, typically represented as "--" in most pages.
- "silo". Matches text that contains "silo".
- "!silo". Matches text that does not contain "silo".
- "!^silo\$". Matches all text except the text "silo", with no characters before or after.
- "-3,7-8,11,24,50-". Matches numbers 1, 2, 3, 7, 8, 11, 24, 50, and all numbers greater than 50.
- "-3,7-8,11,24,50-,a". Matches numbers 1, 2, 3, 7, 8, 11, 24, 50, and all numbers greater than 50, and text that includes "a".
- "?n". Matches text that contains any single character and the character "n". For example, this string would match "an", "bn", "cn", "1n", and "2n".
- "n\*SAN". Matches text the contains "n", zero or any number of any characters and then "SAN". For example, the string would match "nSAN", and "nhamburgerSAN".
- "^?n\*SAN\$". Matches text that begins with any single character, is following by "n", and then zero or any number of any characters, and ends in "SAN".

---

## Managing the Dynamic Applications Aligned to a Device

You can view detailed data about a specific device by clicking the device name on the **Devices** page () to open the **Device Investigator** page for that device.

The **[Collections]** tab of the **Device Investigator** displays a list of the Dynamic Applications associated with the device.

This section describes how to view and manage the Dynamic Applications associated with a device using the **[Collections]** tab of the **Device Investigator**.

## Viewing the List of Dynamic Applications Aligned to a Device

On the **[Collections]** tab of the **Device Investigator**, you can view a list of the Dynamic Applications associated with the device:

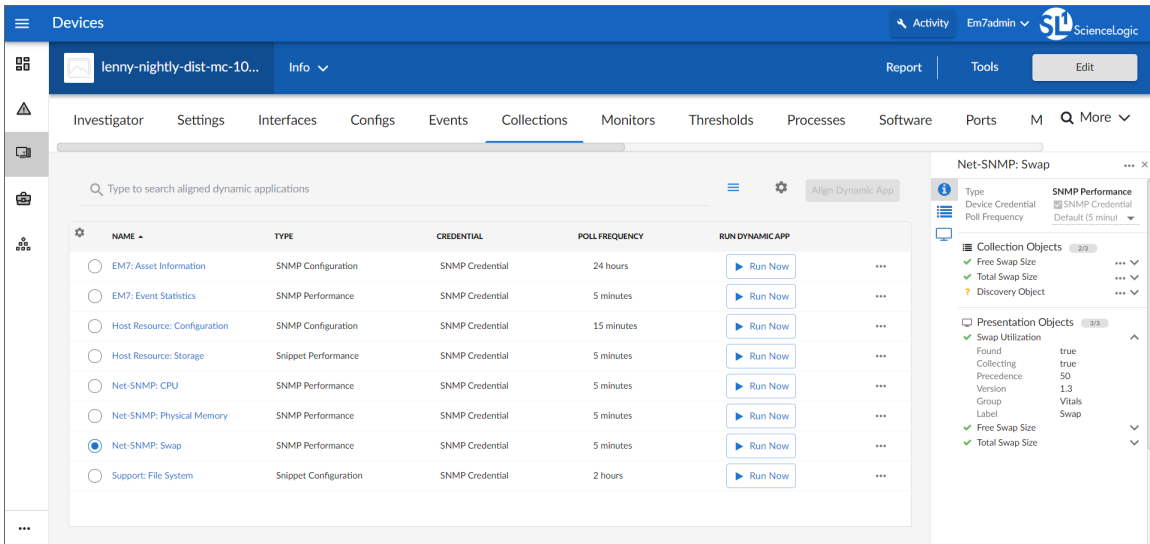

For each Dynamic Application in the list, the **[Collections]** tab displays the following information:

- **Name.** Name of the Dynamic Application.
- **Type.** The protocol used by the Dynamic Application (Database [SQL], Internal Collection Inventory or Internal Collection Performance (ICDA), Snippet [Python], SNMP, SOAP, WMI, XML, or XSLT) and the type of data collected by the Dynamic Application (Configuration, Performance, or Journal).
- **Credential.** Name of the credential that SL1 uses to access the device and retrieve the data specified in the Dynamic Application.

**NOTE:** Cache-consuming Dynamic Applications do not require a credential. If you aligned a cache-consuming Dynamic Application in the **Align Dynamic Application** modal page, the **Credential** field displays *N/A* and is grayed out. You do not have to select a credential in the **Align Dynamic Application** modal page.

- **Poll Frequency.** Frequency at which SL1 will query the device to retrieve the data specified in the Dynamic Application. Each Dynamic Application includes a default frequency. From this page (the **[Collections]** tab), if you have the proper user permissions, you can change the poll frequency for a Dynamic Application on the current device. This edited poll frequency will override the default frequency for the Dynamic Application and the poll frequency defined for a Dynamic Application in one or more device templates.



**TIP:** To rearrange the columns in the List View, click and drag the column name to a new location. You can adjust the width of a column with by clicking and dragging the right edge of the column. You can click the **Select Columns** icon (⚙️) to add or remove columns, or to reset columns to their default settings.

On the **[Collections]** tab, you can:

- [View information about a Dynamic Application](#)
- [Change the credential for a Dynamic Application](#)
- [Update the poll frequency for a Dynamic Application](#)
- [Align or unalign Dynamic Applications with the device](#)
- [View the collection status for a Dynamic Application](#)
- [Enable or disable collection for the device's Dynamic Applications](#)
- [Enable or disable collection for individual collection objects within a Dynamic Application](#)
- [Run a Dynamic Application](#)

## Viewing Information about a Dynamic Application Aligned to a Device

To view more information about a Dynamic Application that is aligned to the device, select that Dynamic Application from the list on the **[Collections]** tab. An information pane with details about that Dynamic Application appears on the right side of the page:

The screenshot shows the 'Collections' tab in a management interface. A table lists various dynamic applications. The 'Net-SNMP: Swap' application is selected, and its details are shown in a right-hand pane. The table has columns for NAME, TYPE, CREDENTIAL, POLL FREQUENCY, and RUN DYNAMIC APP. The details pane shows configuration options like Type, Device Credential, and Poll Frequency, along with expandable sections for Collection Objects and Presentation Objects.

NAME	TYPE	CREDENTIAL	POLL FREQUENCY	RUN DYNAMIC APP
EM7: Asset Information	SNMP Configuration	SNMP Credential	24 hours	Run Now
EM7: Event Statistics	SNMP Performance	SNMP Credential	5 minutes	Run Now
Host Resource: Configuration	SNMP Configuration	SNMP Credential	15 minutes	Run Now
Host Resource: Storage	Snippet Performance	SNMP Credential	5 minutes	Run Now
Net-SNMP: CPU	SNMP Performance	SNMP Credential	5 minutes	Run Now
Net-SNMP: Physical Memory	SNMP Performance	SNMP Credential	5 minutes	Run Now
<b>Net-SNMP: Swap</b>	SNMP Performance	SNMP Credential	5 minutes	Run Now
Support: File System	Snippet Configuration	SNMP Credential	2 hours	Run Now

**Net-SNMP: Swap** Details:

- Type: SNMP Performance
- Device Credential: SNMP Credential
- Poll Frequency: Default (5 minut)
- Collection Objects (29):
  - Free Swap Size
  - Total Swap Size
  - Discovery Object
- Presentation Objects (39):
  - Swap Utilization
    - Found: true
    - Collecting: true
    - Precedence: 50
    - Version: 1.3
    - Group: Vitals
    - Label: Swap
  - Free Swap Size
  - Total Swap Size

This information pane includes three sections:

- **Info** (i). This section provides basic information about the Dynamic Application. From here, if you have the proper user permissions, you can also [change the Dynamic Application's credential](#) and [update its poll frequency](#).
- **Collection Objects** (☰). This section lists the Dynamic Application's collection objects. Each collection object in a Dynamic Application specifies a data point that SL1 will attempt to collect.
- **Presentation Objects** (☐). This section lists the Dynamic Application's presentation objects. Presentation objects define how SL1 should present data for performance or journal Dynamic Applications.

You can click the expand icon (∨) next to each collection object and presentation object to see additional information about that object, including its collection status. For more information, see the section on [Viewing the Status of a Dynamic Application](#).

If you have the proper user permissions, you can also enable or disable collection for certain collection objects. For more information, see the section on [Enabling and Disabling Collection for Specific Collection Objects](#).

## Changing the Credential for a Dynamic Application Aligned to a Device

If you have the proper user permissions, you can use the information pane for a Dynamic Application listed on the **[Collections]** tab to change the credential aligned to that Dynamic Application.

To change the credential for a Dynamic Application aligned to a device:

1. On the **[Collections]** tab of the **Device Investigator**, click **[Edit]** and select the Dynamic Application you want to update. The information pane for the Dynamic Application appears.
2. If *SNMP Credential* is currently checked in the **Device Credential** field, uncheck the checkbox. The **Credential** field appears below it.
3. In the **Credential** field, click the edit icon (✎). The **Choose Credential** modal page appears.
4. In the **Choose Credential** modal page, search for the credential you want to align with the Dynamic Application and select it from the list, then click **[Select]**. Your selected credential appears in the **Credential** field.
5. Click **[Save]**.

## Updating the Poll Frequency for a Dynamic Application Aligned to a Device

If you have the proper user permissions, you can use the information pane for a Dynamic Application listed on the **[Collections]** tab to change the default poll frequency at which the Dynamic Application queries the device for data.

To change the poll frequency and collection status for a Dynamic Application:

1. On the **[Collections]** tab of the **Device Investigator**, click **[Edit]** and select the Dynamic Application you want to update. The information pane for the Dynamic Application appears.

- From the **Poll Frequency** drop-down, select how often you want the Dynamic Application to collect data from the device. Your options range from *1 minute* to *24 hours*, or you can select *Default* to not change the frequency.
- Click **[Save]**.

## Manually Aligning a Dynamic Application to a Device

If you have the proper user permissions, you can manually align a new Dynamic Application to a device or unalign a currently aligned Dynamic Application from a device.

To align a Dynamic Application to a device:

- On the **[Collections]** tab of the **Device Investigator**, click **[Edit]** and then click **[Align Dynamic App]**. The **Align Dynamic Application** window appears.
- Click *Choose Dynamic Application*. The **Choose Dynamic Application** window appears:

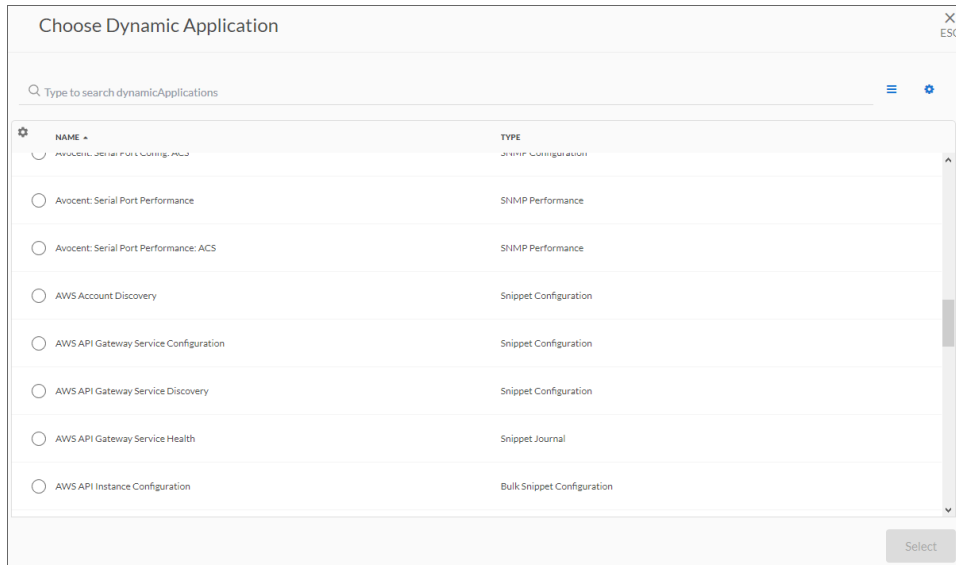



- Select the Dynamic Application you want to align and click **[Select]**. The name of the selected Dynamic Application appears in the **Align Dynamic Application** window.
- If a default credential is listed below the Dynamic Application and you want to use that credential, skip ahead to step 7. Otherwise, uncheck the box next to the credential name.
- Click *Choose Credential*. The **Choose Credential** window appears.
- Select the credential for the Dynamic Application and click the **[Select]** button. The name of the selected credential appears in the **Align Dynamic Application** window.
- Click the **[Align Dynamic App]** button. When the Dynamic Application is successfully aligned, it is added to the **Collections** tab, and a confirmation message appears at the bottom of the tab.

**TIP:** To *unalign* a Dynamic Application from a device, click the **[Actions]** button (☰) for that Dynamic Application and select *Unalign Dynamic App*. However, be advised that when you unalign a Dynamic Application, you also delete the data it has collected.

## Viewing the Status of a Dynamic Application Aligned to a Device

The **[Collections]** tab of the **Device Investigator** displays the status of each collection object within each Dynamic Application aligned to a device.

The following icons represent the different collection statuses:

Icon	Status
	Found and collecting
	Found and not collecting
	Not found and collecting

For more information about these status, see the sections on the [Found status](#) and the [Collecting status](#).

**NOTE:** Before determining which collection objects defined in a Dynamic Application will be collected, SL1 determines whether the Dynamic Application itself should be collected. Dynamic Applications are not collected for devices that are unavailable (because of a failed availability check) or have collection disabled (either manually by a user or because of maintenance scheduled in SL1), regardless of the **Collecting** value of the objects.

## Understanding the Found Status

The **Found** status for a collection object indicates whether data has ever been successfully collected for that object from that specific device.

For a presentation object, the **Found** status indicates whether every collection object used by that presentation object has a **Found** value of Yes.

After **Found** is set to Yes for an object, SL1 will never automatically change the value of **Found** for this object.

The value of **Found** is used by SL1 to determine whether icons, tabs, and NavBar links that lead to the **[Performance]** or **[Configs]** page where the collection object is used should be active.

## Understanding the Collecting Status

The **Collecting** status for a collection object indicates whether SL1 will attempt to collect data for this object when collection for this Dynamic Application occurs. For information about how SL1 determines the **Collecting** status, see the section on [How SL1 Manages the Collection Status for Dynamic Applications](#).

If you have the proper user permissions, you can disable or enable collection for individual collection objects. For more information, see the section on [Enabling and Disabling Collection for Specific Collection Objects](#).

For a presentation object, the **Collecting** status indicates whether every collection object used by that presentation object has a **Collecting** value of Yes. If a collection object has a **Collecting** value of No, then every presentation object that uses that collection object will also have a **Collecting** value of No.

On the flip side, the **Collecting** status for a presentation object has no effect upon its collection objects. If you manually change the **Collecting** status for a presentation object, the **Collecting** status for the collection objects used by the presentation object will not change.

## Enabling and Disabling Dynamic Application Data Collection for a Device

If you have the proper user permissions, you can disable data collection for a particular Dynamic Application on a specific device. This will affect collection only for that Dynamic Application on that device. For all other subscriber devices, SL1 will continue to use the Dynamic Application to collect data.

To disable or enable all collection for a Dynamic Application:

1. On the **[Collections]** tab for the device, click **[Edit]**.
2. To disable collection for a Dynamic Application, click the **[Actions]** button (☰) for that Dynamic Application and select *Disable Collection*. To enable collection for a disabled Dynamic Application, click the **[Actions]** button (☰) and select *Enable Collection*.
3. Click **[Save]**.

## Enabling and Disabling Collection for Specific Collection Objects

If you have the proper permissions, you can disable data collection for specific collection objects within a Dynamic Application that is aligned to a device. Doing so will affect collection only for that collection object within that Dynamic Application for that specific device; the collection status will not change for any other collection objects, Dynamic Applications, or devices. For all other devices, SL1 will use the default list of objects from the Dynamic Application's definition or will use the list of objects defined on the **[Collections]** tab for that device.

To disable or enable collection for specific collection objects within a Dynamic Application:

1. On the **[Collections]** tab for a device, click **[Edit]** and select the Dynamic Application you want to update. The information pane for the Dynamic Application appears.

2. To disable collection for an individual collection object, click the **[Actions]** button (☰) for that object in the information pane and select *Disable Collection*. To enable collection for a disabled object, click the **[Actions]** button (☰) and select *Enable Collection*.
3. Click **[Save]**.

## Running a Dynamic Application on a Device

On a single device, you can perform a test run of collection with a single Dynamic Application, if you have the proper user permissions. During this test run, SL1 displays details of each step of the collection process. This information can be very helpful for troubleshooting and debugging.

**NOTE:** During a test run of a collection with a Dynamic Application, SL1 does not store the collected data or generate alerts. SL1 will continue to collect data and generate alerts using the selected Dynamic Application at the frequency defined in the Dynamic Application.

To execute a test run of collection with a single Dynamic Application:

1. On the **[Collections]** tab for the device, do one of the following:
  - Click the **[Run Now]** button in the *Run Dynamic App* column.
  - Click the **[Actions]** button (☰) for the Dynamic Application that you want to run and select *Run Now*.
  - Select the Dynamic Application from the list to open its information pane. On the information pane, click the **[Actions]** button (☰) and then select *Run Now*.
2. A status window displays the status and relevant logs for the Dynamic Application.

---

## Managing the Dynamic Applications Associated with a Device in the Classic SL1 User Interface

This section describes how to view and manage the Dynamic Applications associated with a device using the **Dynamic Application Collections** page in the classic SL1 user interface.

### Viewing the Dynamic Applications Associated with a Device in the Classic SL1 User Interface

To view the Dynamic Applications associated with a device:

1. Go to the **Device Manager** page (Devices > Device Manager).
2. In the **Device Manager** page, find the device for which you want to view Dynamic Applications. Select its wrench icon ()
3. In the **Device Administration** panel, select the **[Collections]** tab.

4. The **Dynamic Application Collections** page displays a list of all Dynamic Applications aligned with the current device. For each Dynamic Application, the **Dynamic Application Collections** page displays the following read-only information:

Close	Properties	Thresholds	Collections	Monitors	Schedule		
Logs	Toolbox	Interfaces	Relationships	Tickets	Redirects	Notes	Attributes
Device Name	10.2.117.3			Managed Type	Physical Device		
IP Address / ID	10.2.117.3   135			Category	Storage Array		
Class	Pure Storage			Sub-Class	FlashArray Storage System		
Organization	Knights_Pure			Uptime	0 days, 00:00:00		
Collection Mode	Active			Collection Time	2018-07-20 14:07:00		
Description				Group / Collector	CUG-Knights-OL7   10-64-171-139-CU-Knights		
Device Hostname							

Dynamic Application™ Collections							Expand	Actions	Reset	Guide
Dynamic Application	ID	Poll Frequency	Type	Credential	Collector					
+ Pure Storage: Array Capacity Stats	1552	5 mins	Snippet Performance	Knights - Pure Storage	10-64-171-139-CU-Kr					
+ Pure Storage: Array Stats	1543	5 mins	Snippet Performance	Knights - Pure Storage	10-64-171-139-CU-Kr					
- Pure Storage: Temperature Stats	1553	5 mins	Snippet Performance	Knights - Pure Storage	10-64-171-139-CU-Kr					
Presentation Object *										
+ [Temperature [°C]		1	Version	Pid	Found	Collecting	Group	Label	Precedence	
+ [Temperature [°F]		1		p_6298	yes	yes	--	--	0	
				p_6299	yes	yes	--	--	0	
Misc Collection Object *										
[Discovery Object				Cid	Found	Collecting				Edited By
[Temperature (Labels)				o_17691	no	yes				--
				p_17690	yes	yes				--
+ Pure Storage: Array Discovery	1542	15 mins	Snippet Configuration	Knights - Pure Storage	10-64-171-139-CU-Kr					
+ Pure Storage: Controller Config	1554	15 mins	Snippet Configuration	Knights - Pure Storage	10-64-171-139-CU-Kr					
+ Pure Storage: Drive Config	1550	15 mins	Snippet Configuration	Knights - Pure Storage	10-64-171-139-CU-Kr					
+ Pure Storage: Hardware Config	1551	15 mins	Snippet Configuration	Knights - Pure Storage	10-64-171-139-CU-Kr					
+ Pure Storage: Hosts & Groups Config	1558	15 mins	Snippet Configuration	Knights - Pure Storage	10-64-171-139-CU-Kr					
+ Pure Storage: Message Log Config	1555	15 mins	Snippet Configuration	Knights - Pure Storage	10-64-171-139-CU-Kr					
+ Pure Storage: Protection Groups Config	1556	15 mins	Snippet Configuration	Knights - Pure Storage	10-64-171-139-CU-Kr					
+ Pure Storage: Volume Discovery	1544	15 mins	Snippet Configuration	Knights - Pure Storage	10-64-171-139-CU-Kr					
+ Pure Storage: Volume Snapshots Config	1548	15 mins	Snippet Configuration	Knights - Pure Storage	10-64-171-139-CU-Kr					

[Select Action] [Go]

Save

- **Plus Sign** (+). Clicking on this icon displays a list of all Presentation Objects included in Dynamic Applications of type "Performance" and "Journal" or a list of all Collection Objects included in Dynamic Applications of type "Configuration". You can click on the plus sign next to each Presentation Object to see all the Collection Objects included in the Presentation Object.
- **Minus Sign** (-). Collapses a Dynamic Application and hides the display of Presentation Objects and Collection Objects.
- **Dynamic Application**. Name of the Dynamic Application.
- **ID**. Numeric ID for the Dynamic Application.
- **Poll Frequency**. Frequency at which SL1 will query the device to retrieve the data specified in the Dynamic Application. Each Dynamic Application includes a default frequency. From this page (**Dynamic Application Collections**), you can change the poll frequency for a Dynamic Application on the current device. This edited poll frequency will override the default frequency for the Dynamic Application and the poll frequency defined for a Dynamic Application in one or more device templates.

- **Type.** The protocol used by the Dynamic Application (Database [SQL], Internal Collection Inventory or Internal Collection Performance (ICDA), Snippet [Python], SNMP, SOAP, WMI, XML, or XSLT) and the type of data collected by the Dynamic Application (Configuration, Performance, or Journal).
- **Credential.** Name of the credential that SL1 uses to access the device and retrieve the data specified in the Dynamic Application.

**NOTE:** Cache-consuming Dynamic Applications do not require a credential. If you aligned a cache-consuming Dynamic Application in the **Dynamic Application Alignment** modal page, the **Credential** field displays *N/A* and is grayed out. You do not have to select a credential in the **Dynamic Application Alignment** modal page.

- **Collector.** Name of the specific Data Collector used to collect data from the Dynamic Application.

**NOTE:** Based on the Dynamic Application's **Collector Affinity** settings, the Dynamic Application might be assigned to a different Data Collector than the Data Collector that is assigned to the device in the Device Properties page (Devices > Device Manager > wrench icon). In the **Dynamic Application Collections** page, hover your mouse over the **Collector** name for any of the Collection Objects to view a tooltip that explains why the Dynamic Application is assigned to its particular Data Collector.

- **Run Dynamic Application** (). Performs a test run of data collection for the selected Dynamic Application on the current device.

**NOTE:** If a device is currently unavailable, the lightning-bolt icon () will be grayed out for each Dynamic Application aligned with the device.

- **Checkbox** (). Apply an action from the **Select Action** field to this instance of the Dynamic Application.

## Manually Associating a Dynamic Application with a Device in the Classic SL1 User Interface

From the **Dynamic Application Collections** page, you can manually associate a new Dynamic Application with a device.

To manually associate a Dynamic Application with a device:

1. Go to the **Device Manager** page (Devices > Device Manager).
2. In the **Device Manager** page, find the device you want to associate with a Dynamic Application. Click its wrench icon (.
3. In the **Device Administration** panel, click the **[Collections]** tab.



4. In the **Dynamic Application Collections** page, click the **[Actions]** menu and select *Add Dynamic Application*.
5. The **Dynamic Application Alignment** modal page appears. To align a Dynamic Application with a device in this page:

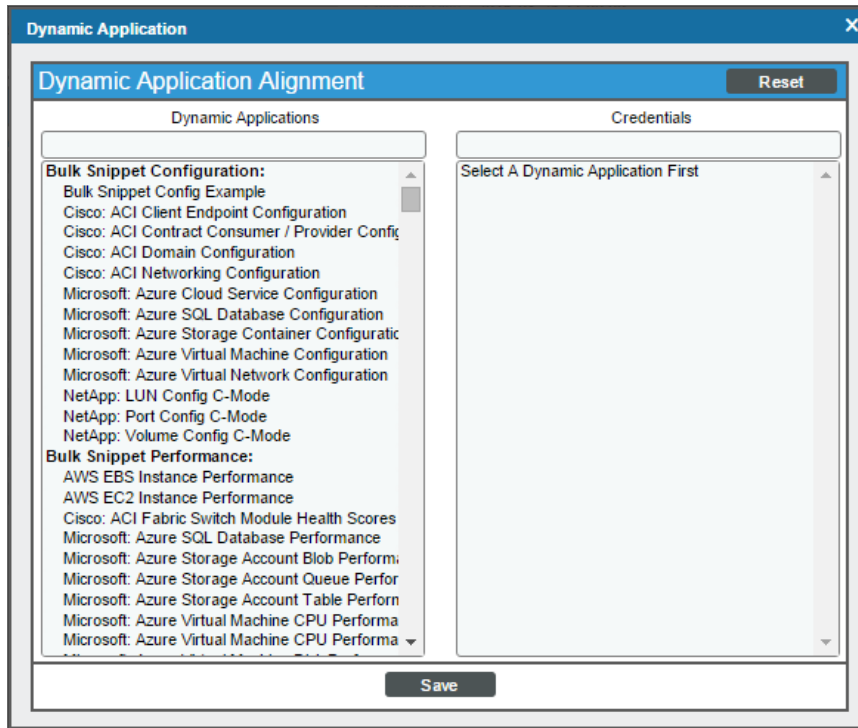

- Select the Dynamic Application you want to align with the device in the **Dynamic Applications** field. You can filter the list of Dynamic Applications using the search field above the **Dynamic Applications** field.
- After selecting a Dynamic Application, you must select a credential. Select a credential in the **Credentials** field. You can filter the list of credentials using the search field above the **Credentials** field.

**NOTE:** Your organization membership(s) might affect the list of credentials you can see in the **Credentials** field.

**NOTE:** Cache-consuming Dynamic Applications **do not** require a credential. If you selected a cache-consuming Dynamic Application in the **Dynamic Application Alignment** modal page, the **Credential** field displays *N/A* and is grayed out. You do not have to select a credential in the **Dynamic Application Alignment** modal page.

6. Click the **[Save]** button in the **Dynamic Application Alignment** modal page to align the Dynamic Application and the credential to the device.
7. SL1 will associate the Dynamic Application with the device and immediately attempt to collect the data specified in the Dynamic Application using the selected credential.
8. After the first, immediate collection, SL1 will collect the data at the frequency defined in the **Polling Frequency** field in the **Application Configuration Editor** page for the Dynamic Application.

## Editing the Credential Associated with a Dynamic Application in the Classic SL1 User Interface

From the **Dynamic Application Collections** page, you can change the credential associated with a Dynamic Application. This credential will be used by SL1 for this specific Dynamic Application associated with this specific device. For all other devices, SL1 will use the default credential associated with the device, or will use the credential defined in the **Dynamic Application Collections** page for each device.

**NOTE:** Cache-consuming Dynamic Applications do not require a credential. If you aligned a cache-consuming Dynamic Application with this device (you do this in the **Dynamic Application Alignment** modal page), the **Credential** field displays *N/A* and is grayed out.

To change the credential associated with a Dynamic Application for a device:

1. Go to the **Device Manager** page (Devices > Device Manager).
2. In the **Device Manager** page, find the device for which you want to define a credential. Select its wrench icon ().
3. In the **Device Administration** panel, select the **[Collections]** tab.
4. In the **Dynamic Application Collections** page, find the Dynamic Application for which you want to change the credential. Select its checkbox (). To apply a credential to multiple Dynamic Applications, select the checkbox for each Dynamic Application.

- From the **Select Action** drop-down list, select the credential from the list of all credentials that you are allowed to use, and then select the **[Go]** button.

The screenshot shows the SL1 user interface for a device configuration. At the top, there are tabs for Close, Properties, Thresholds, Collections, Monitors, Schedule, Logs, Toolbox, Interfaces, Relationships, Tickets, Redirects, Notes, and Attributes. The main content area is divided into two sections: a top section for device details and a bottom section for 'Dynamic Application Collections'.

The device details section includes fields for Device Name (10.2.117.3), IP Address / ID (10.2.117.3 | 135), Class (Pure Storage), Organization (Knights\_Pure), Collection Mode (Active), and Device Name. It also shows Managed Type (Physical Device), Category (Storage Array), Sub-Class (FlashArray Storage System), Uptime (0 days, 00:00:00), Collection Time (2018-07-20 14:07:00), and Group / Collector (CUG-Knights-OU7 | 10-64-171-139-CU-Knights).

The 'Dynamic Application Collections' section is a table with columns: Dynamic Application, ID, Poll Frequency, Type, and Credential. The table lists various collection objects such as 'Pure Storage: Array Capacity Stats', 'Pure Storage: Array Stats', 'Pure Storage: Temperature Stats', etc. A dropdown menu is open over the 'Credential' column, showing a list of credentials including 'Default SNMP Credential', 'Cisco SNMPV2 - Example', 'Dell EMC Isilon SNMPV2 Example', and 'SNMP Public V1'. A 'Go' button is visible at the bottom right of the dropdown.

**NOTE:** Your organization membership(s) might affect the list of credentials you can see in the **Select Action** drop-down list.

**NOTE:** If this Dynamic Application has already been aligned with a credential to which you do not have access, the **Credential** column will display the value *Restricted Credential*. If you align the device with a different credential, you will not be able to re-align the device with the *Restricted Credential*.

- You should see your change reflected in the **Credential** column in the **Dynamic Application Collections** page.

## Viewing the Status of a Dynamic Application Associated with a Device in the Classic SL1 User Interface

For each device, SL1 maintains the collection status for each collection object in each Dynamic Application aligned with that device. The **Dynamic Application Collections** page displays the status of each collection object for a device as represented by two values: **Found** and **Collect**. The **Dynamic Application Collections** page also displays the **Found** and **Collect** values for each presentation object, which are derived from the status of each collection object used by the presentation object.

## Found

The **Found** status for a collection object has two possible values:

- Yes. Data has been successfully collected from this device for this object. **Found** is set to Yes the first time data is successfully collected from this device for this object.
- No. Data has never been successfully collected from this device for this object. No is the initial value of **Found** for every object when a Dynamic Application is initially aligned with a device.

The **Found** status for a presentation object also has two possible values (Yes and No).

- **If the presentation object uses only one collection object**, the presentation object always has the same default **Found** and default **Collect** values as that collection object.
- **If a presentation object uses multiple collection objects**, the default **Found** value for the presentation object will be Yes only if all the collection objects used by the presentation object have a **Found** value of Yes.

After **Found** is set to Yes for an object, SL1 will never automatically change the value of **Found** for this object.

The value of **Found** is used by SL1 to determine whether icons, tabs, and Navbar links that lead to the **[Performance]** or **[Configs]** page where the collection object is used should be active.

## Collect

The **Collect** status for a collection object has two possible values:

- Yes. SL1 will attempt to collect data for this object when collection for this Dynamic Application occurs. Yes is the initial value for **Collect** for every object when a Dynamic Application is initially aligned with a device.
- No. SL1 will not attempt to collect data for this object when collection for this Dynamic Application occurs. SL1 might set **Collect** to No automatically if no data has been collected.
- If a collection object has a **Collect** value of No, all presentation objects that use that collection object will also have a **Collect** value of No.

The **Collect** status for a presentation object also has two possible values (Yes and No).

- **If the presentation object uses only one collection object**, the presentation object always has the same default **Found** and default **Collect** values as that collection object.
- **If a presentation object uses multiple collection objects**, the default **Collect** value for the presentation object will be Yes only if **all** the collection objects used by the presentation object have a **Collect** value of Yes. If one or more collection objects used by the presentation object have a **Collect** value of No, the presentation object will also have a default **Collect** value of No.
- The **Collect** status for a presentation object has no effect upon its collection objects. If you manually change the **Collect** status for a presentation object, the **Collect** status for the collection objects used by the presentation object will not change.

**NOTE:** Before determining which collection objects defined in a Dynamic Application will be collected, SL1 determines whether the Dynamic Application itself should be collected. Dynamic Applications are not collected for devices that are unavailable (because of a failed availability check) or have collection disabled (either manually by a user or because of maintenance scheduled in SL1) regardless of the **Collect** value of the objects.

## Performing Other Administrative Tasks for an Aligned Dynamic Application in the Classic SL1 User Interface

You can perform the following other administrative tasks for an aligned Dynamic Application in the **Dynamic Application Collections** page:

- Enable or disable one or more collection objects or presentation objects.
- Stop data collection for the whole Dynamic Application.
- Reset the statistical data that has been stored for standard deviation alerting.
- Reset persistent session objects that have been collected and stored for a Dynamic Application.
- Test collection for a Dynamic Application.
- Remove all data collected using the Dynamic Application and optionally unalign the Dynamic Application from the device.

To perform one of these tasks:

1. Go to the **Device Manager** page (Devices > Device Manager).
2. In the **Device Manager** page, find the device for which you want to perform an administrative task. Select its wrench icon ()
3. In the **Device Administration** panel, select the **[Collections]** tab.
4. In the **Dynamic Application Collections** page, find the Dynamic Application for which you want to perform an administrative task. The following sections describe how to perform each task.

### Enabling or Disabling Objects

From the **Dynamic Application Collections** page, you can customize the collection performed by the Dynamic Application for the current device. This customization will be used by SL1 only for this specific device. For all other devices, SL1 will use the default list of objects from the Dynamic Application's definition or will use the list of objects defined in the **Dynamic Application Collections** page for that device.

**NOTE:** If a collection object has a **Collect** value of *No*, all presentation objects that use that collection object will also have a **Collect** value of *No*.

To enable or disable collection for one or more objects in a Dynamic Application:

- **To disable collection for one or more collection objects**, unselect the checkbox for each object for which you want to disable collection.
- For each unselected object, the **Collect** column should now display *No*.
- **To enable collection for one or more collection objects**, select the checkbox for each object for which you want to enable collection.
- For each selected object, the **Collect** column should now display *Yes*.
- Select the **[Save]** button.

**NOTE:** If a user **manually** sets the **Collect** status of a collection object or presentation object to *No*, SL1 will **not** attempt to re-collect the object once a day and will **not** automatically set the **Collect** status to *Yes*.

## Restarting Automatic Maintenance of Collection Objects

If a user **manually** sets the **Collect** status of a collection object or presentation object, SL1 will **not** automatically change the **Collect** status of that object as described in the [How SL1 Manages Collect Status](#) section.

If you want SL1 to restart automatic maintenance of the objects in a Dynamic Application, perform the following steps:

1. In the **Dynamic Application Collections** page, select the checkbox  for the Dynamic Application for which you want to restart automatic collection maintenance. To restart automatic collection maintenance for multiple Dynamic Applications, select the checkbox for each Dynamic Application.
2. From the **Select Action** drop-down list, select *Restore System Control of Collection State* and then select the **[Go]** button.
3. Automatic collection maintenance for all objects in the Dynamic Application will now occur. The **Collect** status of the objects in the Dynamic Application will not change immediately.

## Editing the Poll Frequency for a Dynamic Application on the Current Device

**Poll Frequency** is the frequency at which SL1 will query the device to retrieve the data specified in the Dynamic Application. Each Dynamic Application includes a default frequency.

From the **Dynamic Application Collections** page, you can change the poll frequency for a Dynamic Application on the current device. For the current device, the edited poll frequency will override:

- the default frequency for the Dynamic Application.
- the poll frequency defined for a Dynamic Application in one or more device templates.

To edit the poll frequency for a Dynamic Application on the current device:

1. In the **Dynamic Application Collections** page, select the checkbox  for the Dynamic Application for which you want to change the poll frequency. To change the poll frequency for multiple Dynamic Applications, select the checkbox for each Dynamic Application.
2. From the **Select Action** drop-down list, select *Poll Frequency* from the list of poll frequencies and then select the **[Go]** button.
3. You should see your change reflected in the **Poll Frequency** column in the **Dynamic Application Collections** page.

## Stopping Data Collection for a Dynamic Application

You can stop data collection for a Dynamic Application on the current device. This will affect collection only for this specific device. For all other subscriber devices, SL1 will continue to use this Dynamic Application to collect data.

To stop data collection for a Dynamic Application on this device:

1. Select the checkbox  of each Dynamic Application for which you want to stop data collection.
2. From the **Select Action** drop-down list, select the following:
  - **Disable All Collection Objects.** For all collection objects in the selected Dynamic Application(s), the **Collect** value will be set to *No*.
3. Select the **[Go]** button.

**NOTE:** If a user manually sets the **Collect** status of a collection object or presentation object to *No*, SL1 will not attempt to re-collect the object once a day and will not set the **Collect** status to *Yes*.

## Resetting Statistical Data for a Dynamic Application

SL1 allows you to examine the value of an object and trigger an alert if that value falls outside the range of "normal" values for that object at that hour of the day on that day of the week. The deviation function allows you to define such alerts.

To use the deviation function, you must configure SL1 to store and calculate the mean values and standard deviation for an object. You do this by selecting the **Enable Deviation Alerting** field in the **Collection Objects** page. You then specify the minimum and maximum number of weeks to collect deviation data for the object. SL1 must have already collected at least the minimum number of weeks' worth of values for an object before SL1 will evaluate alert formulas that use the deviation function. To use the deviation function, you must specify a minimum value of at least two weeks.

In some cases, you might want to delete all the collected statistics for an object and start over. This is useful if known circumstances change the value of an object, and you no longer want to use the old data to calculate the "normal" ranges. You can do this by "resetting" the statistical data for an object.

For example, suppose you were monitoring bandwidth usage with a standard deviation alert. Suppose your company previously ran on a 09:00 to 17:00 work schedule. Suppose your company has recently added a nightshift to the schedule. In this circumstance, you might want to reset the statistical data to determine the new "normal" usage patterns.

When you reset the statistical data for an object, you are telling SL1 to ignore all previously collected values and to use only values from today onward. When you reset the statistical data for an object, the **Dynamic Application Collections** page will again display a message like:

```
Note: object 123 not ready for deviation alerting.
```

until enough data has been collected to again calculate standard deviation for the object. SL1 will again start collecting the minimum number of weeks of data for the object (as specified in the **Enable Deviation Alerting** field in the **Collection Objects** page) and calculating the "normal" ranges for those objects for each hour at each day of the week.

To delete all current statistical data for an object:

1. In the Dynamic Application, find the object for which you want to reset data.
2. In that Dynamic Application, find the object for which you want to reset data. Select its checkbox .
3. From the **Select Action** drop-down list, select the following option:
  - **Reset Statistical Data**. Removes all previously collected statistical data for the selected object. SL1 will again start collecting the minimum number of weeks of data for the object (as specified in the **Enable Deviation Alerting** field in the **Collection Objects** page) and calculating the "normal" ranges for those objects for each hour at each day of the week.
4. Select the **[Go]** button.
5. The **Dynamic Application Collections** page will display a message like:

```
Note: object 123 not ready for deviation alerting.
```

## Resetting Persistent Session Objects for a Dynamic Application

SOAP or XSLT Dynamic Applications can contain a collection object that stores a Session ID. The value for this collection object can be defined as a persistent value. If SL1 has already retrieved and stored a value in the collection object for the Session ID, SL1 will not collect a new value for the collection object until a SOAP fault occurs. You can force SL1 to re-collect a Session ID collection object by deleting the current persistent value.

To delete the current persistent value for a session object:

1. In the Dynamic Application, find the object for which you want to reset data. Select its checkbox .





2. From the **Select Action** drop-down list, select the following option:
  - **Reset Persistent Session Objects.** Removes the stored value for collection objects of type **SOAP/XSLT Session ID**. **SOAP/XSLT Session ID** objects are persistent across collection periods; SL1 does not collect a **SOAP/XSLT Session ID** object if a collected value is available from a previous poll. After selecting this option, SL1 will delete the existing value for the object and collect a new value during the next collection.
3. Select the **[Go]** button.

## Testing Data Collection for a Dynamic Application

On a single device, you can perform a test-run of collection with a single Dynamic Application. During this test run, SL1 displays details of each step of the collection process. This information can be very helpful for troubleshooting and debugging.

**NOTE:** During a test run of a collection with a Dynamic Application, SL1 does not store the collected data or generate alerts. SL1 will continue to collect data and generate alerts using the selected Dynamic Application at the frequency defined in the Dynamic Application.

To execute a test run of collection with a single Dynamic Application:

1. Locate the device on which you want to test the Dynamic Application and click its wrench icon ().
2. Click the **Collections** tab.
3. Find the Dynamic Application for which you want to test collection and click its lightning bolt icon ().

**NOTE:** If a device is currently unavailable, the lightning bolt icon () will be grayed out for each Dynamic Application aligned with the device.

2. SL1 displays a **Session Logs** modal that includes details about each step of the collection process and diagnostic details about alerts in the Dynamic Application. This information can be helpful during troubleshooting.

## Removing Data Collected by a Dynamic Application

You can remove the data retrieved with a Dynamic Application from the current device. You have two options for removing Dynamic Application data associated with a device:

- Remove all previously collected data, but continue to collect data at the specified polling frequency.
- Remove all normalized data, but retain all raw collected data and continue to collect data at the specified polling frequency.
- Remove all previously collected data and stop collecting data with this Dynamic Application. This unaligns the device from the Dynamic Application. The device will no longer be a subscriber to the Dynamic Application.

To remove Dynamic Application data associated with a device:

1. In the **Dynamic Application Collections** page, select the checkbox  of the Dynamic Application for which you want to remove data. To remove data for multiple Dynamic Applications, select the checkbox for each Dynamic Application.
2. From the **Select Action** drop-down list, select one of the following options:
  - **Remove Data**. Removes all previously collected data, but data will continue to collect at the specified polling frequency.
  - **Remove Normalized Data**. Removes all normalized data, but all raw collected data is retained and data will continue to collect at the specified polling frequency.
  - **Stop Collection and Remove Data**. Removes all previously collected data and stops collection of data with this Dynamic Application. This "unaligns" the device from the Dynamic Application. The device is no longer considered a subscriber to the Dynamic Application. If you perform this option and later want to subscribe to this Dynamic Application again, you must re-align the device with the Dynamic Application.
3. Select the **[Go]** button.

---

## How SL1 Manages the Collection Status for Dynamic Applications

This section describes how SL1 manages collection for Dynamic Applications, including the conditions under which it might automatically stop or re-start collection. It also describes the types of collection objects for which it will never automatically change the collection status.

### Stopping Collection

One of the ScienceLogic hourly maintenance tasks checks the last collection time for every collection object being collected from every device. If the last collection time for an object on a device is more than 24 hours ago, collection is stopped for that collection object on that device. SL1 will set the **Collect** status of that object to *No*.

**NOTE:** If a device is in maintenance mode, is unavailable, or has been manually disabled by a user, SL1 will not automatically set the **Collect** status of objects to *No*. SL1 will automatically set the **Collect** status of objects to *No* only if the device is up and running, but SL1 still cannot collect the object.

When SL1 sets the **Collect** status of that object to *No*, SL1 generates an event. The event will include the name of the device, the name of the Dynamic Application, the name of the collection object, and the collection object IDs. By default, this event is of severity "notice".

**NOTE:** For Dynamic Applications that have the **Component Mapping** checkbox selected in the **Dynamic Applications Properties Editor** page, SL1 will never automatically set the **Collect** status to *No* for any of the collection objects in the Dynamic Application.

**NOTE:** For Dynamic Applications that have the **Caching** fields set to either *Cache Results* or *Consume cached results* in the **Dynamic Applications Properties Editor** page, SL1 will never automatically set the **Collect** status to *No* for any of the collection objects in the Dynamic Application.

## Starting Collection

For each object that has the **Collect** status of *No*, SL1 will attempt to re-collect the object once a day. If re-collection is successful, SL1 will automatically set the **Collect** value for that object to *Yes*.

**NOTE:** If a user manually sets the **Collect** status of a collection object or presentation object to *No*, SL1 will **not** attempt to re-collect the object once a day and will **not** set the **Collect** status to *Yes*.

## Collection Objects that are Excluded from Maintenance

The **Collect** status of the following collection objects is never changed automatically:

- Collection objects in Dynamic Applications that have the **Component Mapping** checkbox checked in the **Dynamic Applications Properties Editor** page.
- Collection objects in Dynamic Applications that have the **Caching** fields set to either *Cache Results* or *Consume cached results*, in the **Dynamic Applications Properties Editor** page.
- Collection objects that have the **Disable Object Maintenance** setting enabled.
- Collection objects that have a **Collect** status defined by a user, i.e. collection objects that were manually enabled or disabled by a user.

---

## Status of Objects for Deviation

SL1 allows you to examine the value of an object and trigger an alert if that value falls outside the range of "normal" values for that object at the hour of the day on that day of the week. The deviation function allows you to define such alerts.

To use the deviation function, you must configure SL1 to store and calculate the mean values and standard deviation for an object. You do this by selecting the **Enable Deviation Alerting** field in the **Collection Objects** page. You then specify the minimum and maximum number of weeks to collect deviation data for the object. SL1 must have already collected at least the minimum number of weeks' worth of values for an object before SL1 can evaluate alert formulas that use the deviation function. To use the deviation function, you must specify a minimum value of at least two weeks.

If a Dynamic Application in the **Dynamic Application Collections** page contains one or more alerts that use the deviation function, the **Dynamic Application Collections** page displays the status of the collection objects.

For example, suppose an alert in a Dynamic Application will apply the deviation function to object "o\_123". Suppose that you specified that SL1 must collect at least two weeks' worth of deviation data for this object. Suppose that SL1 contains only one weeks' worth of values for object "o\_123". In this case, the **Dynamic Application Collections** page will display the following message:

```
Note: object 123 not ready for deviation alerting.
```

When SL1 contains at least two weeks worth of values for object "o\_123", the **Dynamic Application Collections** page will display the following message:

```
All objects ready for deviation alerting.
```

---

## Bulk Un-Aligning Dynamic Applications

The **Application Subscribers** page contains a drop-down field in the lower right called **Select Action**. This field allows you to un-align a Dynamic Application from one or more subscriber-devices.

To un-align a Dynamic Application from one or more devices:

1. Go to the **Dynamic Applications Manager** page (System > Manage > Dynamic Applications).
2. In the **Dynamic Applications Manager** page, find an application with a subscriber icon () in the **Subscribers** column. Select the icon.

3. The **Application Subscribers** page appears.

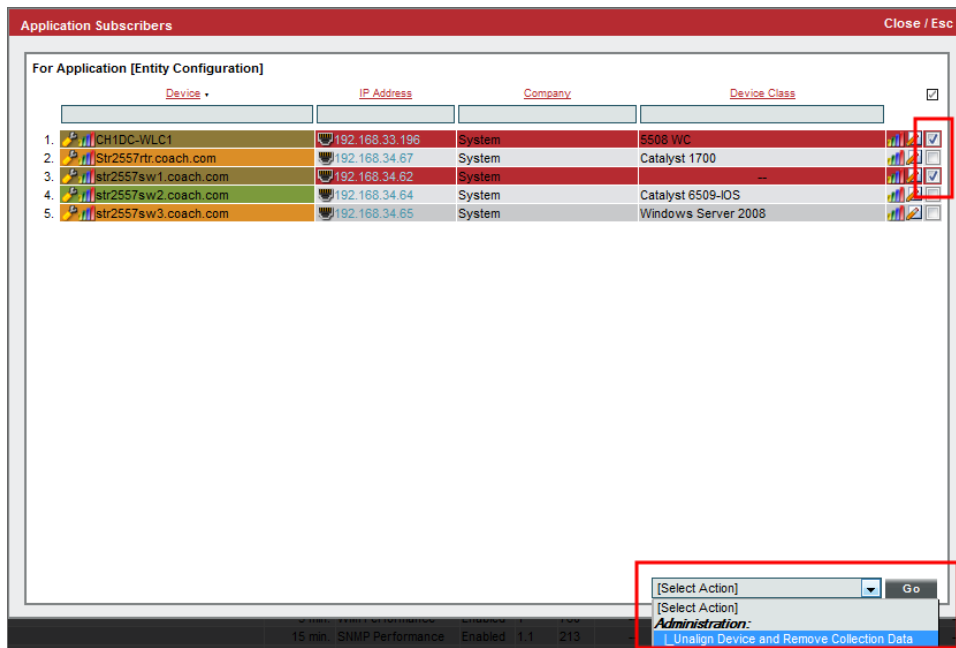

4. In the **Application Subscribers** page, select the checkbox for each device you want to apply the action to. To select all checkboxes for all devices, select the red checkbox () at the top of the page.
5. In the **Select Action** drop-down list, select one of the following actions.
  - **Unalign Device and Remove Collection Data**. This option un-aligns the device from the Dynamic Application and deletes all data collected by the Dynamic Application from the device. The device is no longer considered a subscriber to the Dynamic Application. If you perform this option and later want to subscribe to this Dynamic Application again, you must re-align the device with the Dynamic Application.
6. Select the **[Go]** button to apply the action to all selected devices.

## Setting Thresholds for Dynamic Applications

If a Dynamic Application includes one or more **thresholds**, you can change the threshold value on a per-device basis. To change a Dynamic Application threshold for a device:

1. Go to the **Device Manager** page (Devices > Device Manager).
2. In the **Device Manager** page, find the device for which you want to define a threshold. Select its wrench icon ()
3. In the **Device Administration** panel, select the **[Thresholds]** tab.

- The **Device Thresholds** page displays a list of thresholds defined for each Dynamic Application that is aligned to the device. To change a threshold, move the slider for that threshold or enter a value in the number field for that threshold:

Section	Threshold Name	Current Value	Default Value
Operating System Thresholds	System Latency	100 ms	100 ms
	System Availability	99 %	99 %
Data Retention Thresholds	Device Logs Max	50000 records	50000 records
	Device Logs Age	90 days	90 days
	Bandwidth Data	365 days	365 days
	Daily Rollup Bandwidth Data	365 days	365 days
	Frequent Rollup Bandwidth Data	365 days	365 days
	Hourly Rollup Bandwidth Data	365 days	365 days
	Raw Performance Data	14 days	14 days
	Daily Rollup Performance Data	720 days	720 days
	Frequent Rollup Performance Data	60 days	60 days
	Hourly Rollup Performance Data	365 days	365 days
	Journal Data	60 days	60 days
	Configuration Data	30 records	30 records

- After changing one or more thresholds, select the **[Save]** button to save your changes.

**NOTE:** Changing a threshold in the **Device Thresholds** page affects only the current device. The threshold values defined in the Dynamic Application remain unchanged.

## Dynamic Applications and Discovery

**Discovery** is the ScienceLogic tool that automatically discovers devices in your network. You supply the discovery tool with a range or list of IP addresses, and the discovery tool determines if a device exists at each IP address. The discovery tool also determines which (if any) Dynamic Applications to align with the device. If the discovery tool finds Dynamic Applications to align with the device, the discovery tool triggers collection for each aligned Dynamic Application.

To learn more about discovery, see the **Discovery and Credentials** manual.

### How Does SL1 Align Dynamic Applications During Discovery?

Most Dynamic Applications include a discovery object. A discovery object enables SL1 to determine which devices to align with a Dynamic Application.

During discovery, SL1 :

- Searches the list of Dynamic Applications.

2. If a Dynamic Application includes a discovery object, SL1 adds that Dynamic Application to the list of Dynamic Applications to try to align during discovery.
3. For each Dynamic Application that includes a discovery object, SL1 checks the current discovery session for an appropriate credential. For example, for each database Dynamic Application, SL1 would look for one or more database credentials that have been selected for the discovery session.
4. For each discovered device, both those that support SNMP and those that don't, discovery tries to determine which Dynamic Applications to align. For each discovered device, SL1 tries to align each Dynamic Application in the list of Dynamic Applications to try during discovery. For each Dynamic Application in the list, SL1 tries to connect to each device with each of the appropriate credentials (until SL1 finds a working credential) and then tries to find the discovery object. If SL1 is able to connect to a device with one of the credentials and can then retrieve the discovery object, SL1 will align the Dynamic Application with the device.

**NOTE:** SL1 also includes more sophisticated logic that allows you to define multiple discovery objects, validate the value of the discovery object, and to align the Dynamic Application if a discovery object is not available. However, the most common use of a discovery object is as described above (discovery object exists).

5. If discovery aligns a Dynamic Application with a device, immediately after discovery completes SL1 will start the first collection from that device using the aligned Dynamic Application. This step is not performed for Dynamic Applications that meet all of the following three criteria:
  - Has a collection frequency of 1 minute, 2 minutes, 3 minutes or 5 minutes.
  - Does not have component mapping enabled (does not discover component devices).
  - Is aligned with a component device.

**NOTE:** During discovery, SL1 tries each SNMP credential specified in the discovery session on each discovered device, to determine if SL1 can collect SNMP details from the device. Later in the discovery session, during alignment of Dynamic Applications, discovery again tries each SNMP credential specified in the discovery session. If one of the SNMP credentials times out three times **without any response**, discovery will stop trying to use that SNMP credential to align SNMP Dynamic Applications. Note that "no response" means that a device did not respond at all. Note that if a device reports that "no OID was found" or "the end of the OID tree was reached", these are considered a legitimate response and would not cause SL1 to abandon the credential.

## Queuing Discovery from the Dynamic Applications Manager Page

From the **Dynamic Applications Manager** page, you can manually run the Dynamic Application alignment portion of discovery for all devices in the system using one or more selected Dynamic Applications.

To manually queue discovery from the **Dynamic Applications Manager** page:

1. Go to the **Dynamic Applications Manager** page (System > Manage > Dynamic Applications).

- In the **Dynamic Applications Manager** page, select the checkbox for each Dynamic Application you want to use for discovery.
- In the **Select Action** drop-down list, select *Discover Applications*. Select the **[Go]** button.

Dynamic Applications Manager | Total Found [1552]

Dynamic Application Name	Poll Rate	Type	State	Version	ID	Subscribers	PowerPack	Environment	Collects	Alerts	Events	Thresh	Edited By	Last Edit
1. Not Test ICDA	1 min	Snippet Configuration	Enabled	1	1502	--	ScienceLogic: ICDA Harc	SYSTEM	1	--	--	--	em7admin	2018-07-20 09:27:05
2. 2-level DCM app cache producer	15 min	Snippet Configuration	Enabled	0.1	1517	--	2-level DCM app test	SYSTEM	1	--	--	--	em7admin	2018-07-20 09:26:21
3. 2-level DCM app config	1 min	Snippet Configuration	Enabled	0.1	1520	--	2-level DCM app test	SYSTEM	1	1	1	--	em7admin	2018-07-20 09:26:21
4. 2-level DCM app level1 discovery	1 min	Snippet Configuration	Enabled	0.1	1518	--	2-level DCM app test	SYSTEM	2	--	--	--	em7admin	2018-07-20 09:26:21
5. 2-level DCM app level2 discovery	1 min	Snippet Configuration	Enabled	0.1	1519	--	2-level DCM app test	SYSTEM	2	--	--	--	em7admin	2018-07-20 09:26:21
6. Alteon: Configuration	120 min	SNMP Configuration	Enabled	1.2	1174	--	Alteon Base Pack	n/a	30	15	5	--	em7admin	2018-07-19 23:27:21
7. Alteon: Load Trending	15 min	SNMP Performance	Enabled	1.1	1173	--	Alteon Base Pack	n/a	6	--	--	--	em7admin	2018-07-19 23:27:21
8. Alteon: Performance	15 min	SNMP Performance	Enabled	2.7	1175	--	Alteon Base Pack	n/a	6	--	--	--	em7admin	2018-07-19 23:27:22
9. APC: Environmental T/H	5 min	SNMP Performance	Enabled	6.1	713	--	APC Base Pack	n/a	3	2	2	1	em7admin	2018-07-19 23:24:41
10. APC: Asset Tracking	1440 min	SNMP Configuration	Enabled	1.1	707	--	APC Base Pack	n/a	11	--	--	--	em7admin	2018-07-19 23:24:41
11. APC: Battery Performance	15 min	SNMP Performance	Enabled	1.1	708	--	APC Base Pack	n/a	7	--	--	--		
12. APC: Battery Status	15 min	SNMP Configuration	Enabled	1.2	709	--	APC Base Pack	n/a	9	12	--	--		
13. APC: Configuration	360 min	SNMP Configuration	Enabled	1.1	710	--	APC Base Pack	n/a	20	14	--	--		
14. APC: Environmental Asset	1440 min	SNMP Configuration	Enabled	6.1	714	--	APC Base Pack	n/a	12	--	--	--		
15. APC: PDU Performance	15 min	SNMP Performance	Enabled	1.3	712	--	APC Base Pack	n/a	3	--	--	--		
16. APC: SmartUPS Power Output	5 min	SNMP Performance	Enabled	6.1	715	--	APC Base Pack	n/a	2	--	--	--		
17. APC: UPS Testing	1440 min	SNMP Configuration	Enabled	1.2	711	--	APC Base Pack	n/a	6	19	--	--		
18. Aruba: Asset	1440 min	SNMP Configuration	Enabled	2.8	1434	--	Aruba Base Pack	n/a	18	--	--	--		
19. Aruba: Voice Counters	5 min	SNMP Performance	Enabled	2.8	1435	--	Aruba Base Pack	n/a	15	--	--	--		

[Viewing Page: 1]

[Select Action]

Administration:

- DELETE Application
- CLEAR Application
- DISCOVER Applications
- VALIDATE & REPAIR Applications

Change Type:

- CHANGE to Bulk Snippet Configuration
- CHANGE to Bulk Snippet Performance
- CHANGE to Database Configuration
- CHANGE to Database Performance
- CHANGE to Internal Collection Inventory
- CHANGE to Internal Collection Performance
- CHANGE to IT Service
- CHANGE to PowerShell Config
- CHANGE to PowerShell Performance
- CHANGE to Snippet Configuration
- CHANGE to Snippet Journal
- CHANGE to Snippet Performance
- CHANGE to SNMP Configuration

[Select Action] [Go]

- You can also run the Dynamic Application alignment portion of discovery for all devices in the system using a single Dynamic Application. To do this, select the lightning bolt icon (  ) for that Dynamic Application.



## Device Thresholds and Data Retention

---

### Overview

SL1 allows users to define performance thresholds for devices. When these thresholds are exceeded, SL1 generates an **event**. Events are messages that are triggered when a specific condition is met. For example, an event can signal that a CPU is at maximum capacity or that a device's hard drives are getting too full.

These events have messages like:

- CPU usage exceeded threshold
- Physical Memory usage exceeded threshold
- Virtual Memory usage exceeded threshold
- File system usage exceeded (critical) threshold
- File system usage exceeded (major) threshold
- Bandwidth usage exceeded threshold

These events notify users when hardware is starting to reach its limits. This allows users to fix the problem before a catastrophic hardware or software failure occurs.

Users can define hardware thresholds in two ways:

1. Users can define global hardware thresholds in the **Global Threshold Settings** page (System > Settings > Thresholds), in the **Operating System Thresholds** pane. These global thresholds apply to all hardware discovered by SL1.
2. For a single device, users can override the global hardware thresholds in the **Global Threshold Settings** page (System > Settings > Thresholds). Users can do this in the **Device Thresholds** page.

This chapter describes how to define both types of hardware thresholds.

Use the following menu options to navigate the SL1 user interface:

- To view a pop-out list of menu options, click the menu icon (☰).
- To view a page containing all of the menu options, click the Advanced menu icon (⋮).

This chapter includes the following topics:

<a href="#">Global Settings for Thresholds</a> .....	250
<a href="#">Device Thresholds</a> .....	255
<a href="#">Defining Device Thresholds in the Classic SL1 User Interface</a> .....	261

## Global Settings for Thresholds

The **System Threshold Defaults** page (System > Settings > Thresholds > System) allows you to define global thresholds for system latency, file system usage, counter rollovers, ICMP availability, and number of component devices.



These settings apply to all devices. However, you can override these system settings on a case-by-case basis. For example, you can define thresholds for a device's file systems in the **Device Thresholds** page (Devices > Device Manager > wrench icon > Thresholds). The settings you define for the specific device override the settings in the **System Threshold Defaults** page.

To edit the global settings for system thresholds:

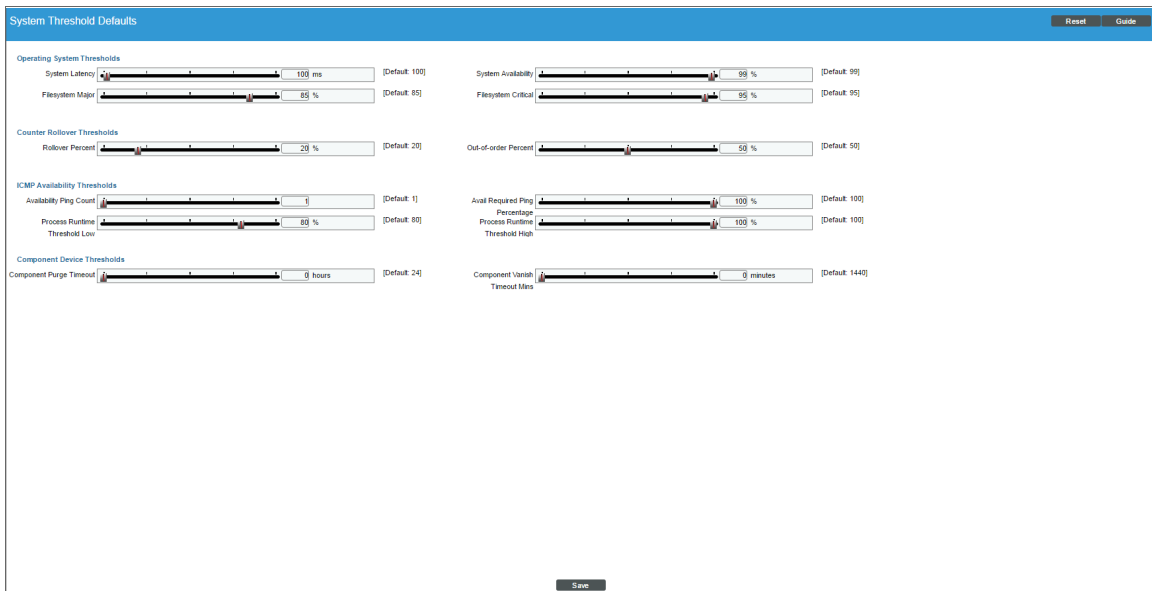
1. Go to the **System Threshold Defaults** page (System > Settings > Thresholds > System).



2. In the **System Threshold Defaults** page, you can drag sliders to change to value of each field or edit a field manually. You can edit the value for one or more of the following fields:

- **Interface Inventory Timeout.** Specifies the maximum amount of time that the discovery processes will spend polling a device for the list of interfaces. After the specified time, SL1 will stop polling the device, will not model the device, and will continue with discovery. The default value is 600,000 ms (10 minutes).
  - During *initial discovery*, initiated from the Discovery Session Editor page (System > Manage > Classic Discovery > Create), SL1 uses the value in this field if there is no differing value specified in the **Discovery Session Editor** page.
  - During *re-discovery* (clicking the binocular icon () in the Device Properties page), SL1 will use the value in this field if there no value is specified in the **Device Thresholds** page (Devices > Device Manager > wrench icon > Thresholds) for the device.
  - During *nightly auto-discovery* (run automatically by SL1 every night, to update device information), SL1 uses the value in this field if no differing value is specified in the **Device Thresholds** page (Devices > Device Manager > wrench icon > Thresholds) for a device.
- **Maximum Allowed Interfaces.** Specifies the maximum number of interfaces per device. If a device exceeds this number of interfaces, SL1 will stop scanning the device, will not model the device, and will continue with discovery. The default value is 10,000.
  - During *initial discovery*, initiated from the **Discovery Session Editor** page (System > Manage > Classic Discovery > Create), SL1 uses the value in this field if there is no differing value specified in the **Discovery Session Editor** page.
  - During *re-discovery* (clicking the binocular icon () in the Device Properties page), SL1 will use the value in this field if there is no differing value is specified in the **Device Thresholds** page (Devices > Device Manager > wrench icon > Thresholds) for the device.
  - During *nightly auto-discovery* (run automatically by SL1 every night, to update device information), SL1 uses the value in this field if no differing value is specified in the **Device Thresholds** page (Devices > Device Manager > wrench icon > Thresholds) for a device.
- **System Latency.** During polling, the platform initially pings monitored devices. The value in this field is the maximum number of milliseconds for the device to respond to SL1's ping (round-trip time divided by 2). The default value is 100 ms. When the latency threshold is exceeded, SL1 generates an event for that device.
- **System Availability.** During polling, SL1 monitors devices for availability. Availability means the device's ability to accept connections and data from the network. The value in this field is the percent availability required of each device. The default value is 99%. When a device falls below this level of availability, SL1 generates an event for that device.

During polling, a device has two possible availability values:

- 100%. Device is up and running.
- 0%. Device is not accepting connections and data from the network.

**NOTE:** Component devices use a Dynamic Application collection object to measure availability. SL1 polls component devices for availability at the frequency defined in the Dynamic Application. For details, see the chapter on *Monitoring Device Availability and Latency* in the **Monitoring Device Infrastructure Health** manual.

**NOTE:** The **Ping & Poll Timeout (Msec)** setting in the **Behavior Settings** page (System > Settings > Behavior) affects how SL1 monitors device availability. This field specifies the number of milliseconds the discovery tool and availability polls will wait for a response after pinging a device. After the specified number of milliseconds have elapsed, the poll will timeout.

- **File System Major.** Threshold that will trigger a "low disk space" event. The default threshold is 85%. When a device has used more disk space than the specified percentage, SL1 will generate a "file system usage exceeded threshold" event with a status of "major".
- **File System Critical.** Threshold that will trigger a "low disk space" event. The default threshold is 95%. When a device has used more disk-space than the specified percentage, SL1 will generate a "file system usage exceeded threshold" event with a status of "critical".

**NOTE:** If you hide a file system in the **Device Hardware** page (Devices > Hardware), SL1 does not generate events for that file system.

- **Rollover Percent.** For any collected data that uses a 32-bit counter, you can specify how SL1 determines that the counter has "rolled over", that is, has reached its maximum value, is reset to zero, and restarts counting. When this happens, the collected values go from the maximum value to a lower value. However, there are multiple circumstances under which a counter value can go from a higher value to a lower value:
  - Maximum value has been exceeded and counter was reset to zero.
  - Retrieved value was manually reset to zero on the external device.
  - Data was collected out-of-order, that is, due to a slowdown somewhere in the network, two counter values were stored out of sequence.

**NOTE:** For 64-bit counters, when the counter values go from a higher value to a lower value, SL1 assumes that the counter has been manually reset or that the two values were collected out of order. SL1 does not assume that the counter has rolled over.

The **Rollover Percent** field allows you to specify a threshold that indicates that a 32-bit counter has reached its maximum value and restarted counting. The default value is 20%. When SL1 records a counter value that is lower than the previously collected value, the platform:

- Calculates the difference between the two counter values (the delta):  

$$2^{32} - \text{Last Collected Value} + \text{Current Collected Value}$$
- Examines the value of the **Rollover Percent** threshold. If the delta is less than the specified percentage of the maximum possible value ( $2^{32}$ ), SL1 concludes that the 32-bit counter rolled over.
- For example, if you specified "25" in this field, SL1 would determine if the delta is less than 25% of the maximum possible value. If the delta is less than 25% of the maximum possible value, SL1 concludes that the 32-bit counter rolled over.
- When SL1 determines a counter has rolled over, SL1 uses the delta value when displaying the data point for this poll period.

**NOTE:** The **Rollover Percent** field applies only to 32-bit counters. If a 64-bit counter value goes from a higher value to a lower value, the change is treated as either a manual reset or an out-of-order collection.

- **Out-of-order Percent.** For any collected data that uses a counter, you can specify how SL1 determines that data has been collected out of order. When this data is collected out of order, the collected values go from a higher value to a lower value. However, there are multiple circumstances under which a counter value can go from a higher value to a lower value:
  - Maximum value has been exceeded and counter was reset to zero (for 32-bit counters only).
  - Data was collected out-of-order, that is, due to a slowdown somewhere in the network, two counter values were stored out of sequence.
  - Retrieved value was manually reset to zero on the external device.

The **Out-of-order Percent** field allows you to specify a threshold that indicates that data has been collected out of order. The default value is 50%. When SL1 records a counter value that is lower than the previously collected value and the platform has determined that the value is not a rollover, SL1:

- Compares the current value to the last collected value:  

$$\text{current value} / \text{last collected value}$$
- If the ratio of current value / last collected value is greater than the percent specified in the **Out-of-order Percent** field, SL1 concludes that the data was collected out of order.
- When SL1 determines a data point has been collected out of order, SL1 uses the following value as the current value of the data point:  

$$\text{last collected value} - \text{current collected value}$$

**NOTE:** If a 32-bit counter value goes from the maximum value to a lower value, and the current collected value does not meet the criteria for a rollover AND the current collected value does not meet the criteria for out-of-order, SL1 concludes that the 32-bit counter was manually reset to zero (0). SL1 uses the current collected value for this data point.

**NOTE:** If a 64-bit counter value goes from a higher value to a lower value, and the current collected value does not meet the criteria for out-of-order, SL1 concludes that the 64-bit counter was manually reset to zero (0). SL1 uses the current collected value for this data point.

- **Availability Ping Count.** If you select *ICMP* in the **Availability Port** field in the **Device Properties** page (Devices > Device Manager > wrench icon) for a device, this field specifies the number of packets that should be sent during each availability check. The default value is "1".
- **Avail Required Ping Percentage.** If you select *ICMP* in the **Availability Port** field in the **Device Properties** page (Devices > Device Manager > wrench icon) for a device, this field specifies the percentage of packets that must be returned during an availability check for SL1 to consider the device available. The default value is "100%".
- **Process Runtime Threshold Low.** Threshold that will trigger a "process time exceeded" event. The default threshold is 80%. When a process has used more than 80% of its allowed **Run Length**, SL1 will generate a "process time exceeded threshold" event with a status of "minor".
- **Process Runtime Threshold High.** Threshold that will trigger a "process time exceeded" event. The default threshold is 100%. When a process has used 100% of its allowed **Run Length**, SL1 will generate a "process time exceeded threshold" event with a status of "major".

**NOTE:** **Run Length** is defined in the **Process Manager** page (System > Settings > Admin Processes).

- **Component Purge Timeout.** This field specifies the number of hours a device can be set to "vanished" before SL1 purges the component device. When a device is purged, SL1 stops trying to collect data about the component device. The purged device will not appear in reports or views on in any pages in the user interface. When a device is purged, all of its configuration data and collected data is deleted from the Database Server. If you set this value to "0", component devices are never purged. You can override this threshold for a specific device in the **Device Thresholds** page for the device.

**NOTE:** When a device is set to "vanished", all children of that device are also set to "vanished". When a device is purged, all children of that device are also purged.

- **Component Vanish Timeout Mins.** If SL1 cannot retrieve information from a root device about a component device, this field specifies how many minutes to wait until putting the component device into "vanish" mode. When a device is set to "vanished", SL1 stops trying to collect data about the component device. The vanished device will not appear in reports or views. The vanished device will appear in the **Vanished Device Manager** page. If you set this value to "0", component devices are never set to "vanished". You can override this threshold for a specific device in the **Device Thresholds** page for the device.

3. Click the **[Save]** button to save changes in this page.

## Device Thresholds

On the **[Thresholds]** tab of the **Device Investigator**, you can define usage and performance thresholds and data retention thresholds for a device:

The screenshot displays the 'Device Thresholds' configuration page for the device 10.64.172.73. The interface includes a navigation bar with tabs for 'lap', 'Monitors', 'Notes', 'Ports', 'Processes', 'Redirects', 'Relationships', 'Schedules', 'Services', 'Software', 'Thresholds', and 'Tickets'. The 'Thresholds' tab is active. The page is divided into four main sections, each with a 'Save' button:

- Dynamic App Thresholds | Automation Remote Login:** Raw Data Retention is set to 7 days (Default: 7).
- Interface Inventory Thresholds:** Interface Inventory Timeout is set to 600000 ms (Default: 600000 ms); Maximum Allowed Interfaces is set to 10000 (Default: 10000 interfaces).
- Operating System Thresholds:** System Latency is set to 100 ms (Default: 100 ms); System Availability is set to 99% (Default: 99%).
- Data Retention Thresholds:** Device Logs Max is set to 10000 records (Default: 10000 records); Device Logs Age is set to 90 days (Default: 90 days); Bandwidth Data is set to 31 days (Default: 31 days); Daily Rollup Bandwidth Date is set to 730 days (Default: 730 days).

When performance thresholds are exceeded, SL1 will generate an event for the device. When space thresholds are exceeded, SL1 will remove the oldest data from the database. For each of these thresholds, SL1 defines a default value. You can edit the thresholds to meet your needs.

The thresholds defined for the device on the **[Thresholds]** tab override the global thresholds defined in the **Global Threshold Settings** page (System > Settings > Thresholds) and the **Data Retention Settings** page (System > Settings > Data Retention).

To define thresholds for a device:

1. Go to the **[Thresholds]** tab of the **Device Investigator**.

2. On the **[Thresholds]** tab, you can define one or more of the following thresholds:
- **Dynamic Application Thresholds.** If the device is a subscriber for one or more Dynamic Applications, this page can include threshold objects from those Dynamic Applications. By default, each threshold object will have the default value as defined in its Dynamic Application. However, on this page you can define a threshold value specifically for the current device. You can define a custom value for each threshold object, and SL1 will use that custom value when evaluating Dynamic Application alerts **for this device**. The following data retention thresholds always appear for Dynamic Applications of type performance:
    - *Raw Data Retention.* Number of days to retain raw performance data collected from the device using this Dynamic Application. Raw data that is older than the specified number of days is automatically deleted.
    - *Hourly Rollup Performance Data.* Number of days to retain hourly normalized data for this Dynamic Application. Hourly normalized data that is older than the specified number of days is automatically deleted.
    - *Daily Rollup Performance Data.* Number of days to retain daily normalized data for this Dynamic Application. Daily normalized data that is older than the specified number of days is automatically deleted.

**NOTE:** The default values for the Dynamic Application Thresholds fields are defined on the **Data Retention Settings** page (System > Settings > Data Retention).

- **Interface Inventory Thresholds.** When a device has a large number of interfaces, these settings prevent SL1 from consuming too many resources during *re-discovery* (clicking the binocular icon ) in the **Device Properties** page) and during *auto-discovery* (run automatically by SL1 every night, to update device information).
  - *Interface Inventory Timeout.* Specifies the maximum amount of time that the discovery processes will spend polling a device for the list of interfaces. After the specified time, SL1 will stop scanning the device, will not update the device, and will continue with discovery. The default value is 600,000 ms (10 minutes).
  - *Maximum Allowed Interfaces.* Specifies the maximum number of interfaces per device. If a device exceeds this number of interfaces, SL1 will stop scanning the device, will not update the device, and will continue with discovery. The default value is 10,000.
- **File System Thresholds.** For each file system on the device that has been detected by SL1, you can define two thresholds:
  - *Major.* Threshold that will trigger a "low disk space" event. The default threshold is 85%. When a device has used more disk space than the specified percentage, SL1 will generate a "file system usage exceeded threshold" event with a status of "major". **To disable this threshold for the current device**, set the threshold to 0% (zero percent). When you disable a threshold, SL1 does not generate an event for the threshold.



- *Critical*. Threshold that will trigger a "low disk-space" event. The default threshold is 95%. When a device has used more disk space than the specified percentage, SL1 will generate a "file system usage exceeded threshold" event with a status of "critical". **To disable this threshold for the current device**, set the threshold to 0% (zero percent). When you disable a threshold, SL1 does not generate an event for the threshold.

**NOTE:** If you hide a file system in the **Device Hardware** page (Devices > Hardware), SL1 does not monitor the thresholds on the file system and does not generate events for that file system.

- **Operating System Thresholds**. You can define the following two thresholds for the device. The thresholds defined for the device in this page override the global thresholds defined in the **Global Threshold Settings** page (System > Settings > Thresholds).
  - *System Latency*. Every five minutes, SL1 polls monitored devices to determine latency. The value in this field is the maximum number of milliseconds for the device to respond to SL1's poll (round-trip time divided by two). The default threshold value is 100ms. When the latency threshold is exceeded, SL1 generates an event ("network latency exceeded threshold") for that device. **To disable this threshold for the current device**, set the threshold to 0 (zero) milliseconds. When you disable a threshold, SL1 does not generate an event for the threshold.
  - *System Availability*. Every five minutes, SL1 polls devices for availability. The default threshold value is 99%. Availability means the device's ability to accept connections and data from the network. The value in this field is the percent availability required of each device. When a device falls below this level of availability, SL1 generates an event for that device.

For availability collection, a device has two possible availability values:

- 100%. Device is up and running.
- 0%. Device is not accepting connections and data from the network.

However, you might see values other than 100 or 0 in an availability report. If a report contains any other percentage, it is an average of multiple readings. For example, if SL1 gathered five readings and during one of those readings a device was unavailable, the average would be 80% ( $100 + 100 + 100 + 100 + 0 = 400$ ;  $400/5 = 80$ ).

**NOTE:** Component Devices use a Dynamic Application collection object to measure availability. SL1 polls component devices for availability at the frequency defined in the Dynamic Application. For details, see the description of the **Component Identifier** field in the **Collection Objects** page. For details, see the manual **Monitoring Device Infrastructure Health**.

- **Data Retention Thresholds**. These thresholds specify how long SL1 will store data collected from the device. The thresholds defined for the device on this page override the global thresholds defined in the **Data Retention Settings** page (System > Settings > Data Retention).
  - *Device Logs Max*. Maximum number of records to store in the device log. The default value is 50,000 entries. When this number is exceeded, the oldest entries will be removed.

- *Device Logs Age*. Number of days to retain device logs. Log records that are older than the specified number of days are automatically removed. The default value is 90 days.
- *Bandwidth Data*. Number of days to retain bandwidth data and CBQoS data collected from each interface on a device . Bandwidth data that is older than the specified number of days is automatically removed. The default value is 270 days.
- *Daily Rollup Bandwidth Data*. Number of days to retain daily normalized data and daily normalized CBQoS data for each interface on the device. Daily normalized data that is older than the specified number of days is automatically deleted. The default value is defined in the **Data Retention Settings** page.
- *Hourly Rollup Bandwidth Data*. Number of days to retain hourly normalized data and hourly normalized CBQoS data for each interface on a device. Hourly normalized data that is older than the specified number of days is automatically deleted. The default value is defined in the **Data Retention Settings** page.
- *Raw Performance Data*. Number of days to retain performance data collected from the device. This setting applies to availability statistics, latency statistics, file system statistics, statistics generated by monitoring policies, and Performance Dynamic Applications for which a specific **Raw Data Retention** setting has not been defined. Performance data that is older than the specified number of days is automatically deleted. The default value is defined in the **Data Retention Settings** page.
- *Daily Rollup Performance Data*. Number of days to retain daily normalized performance data for the device. This setting applies to daily normalized availability data, normalized latency data, normalized file system data, normalized data for monitoring policy statistics, and normalized data for Performance Dynamic Applications for which a specific **Daily Rollup Retention** setting has not been defined. Daily normalized performance data that is older than the specified number of days is automatically deleted. The default value is defined in the **Data Retention Settings** page.
- *Hourly Rollup Performance Data*. Number of days to retain hourly normalized performance data for the device. This setting applies to hourly normalized availability data, normalized latency data, normalized file system data, normalized data for monitoring policy statistics, and normalized data for Performance Dynamic Applications for which a specific **Hourly Rollup Retention** setting has not been defined. Hourly normalized performance data that is older than the specified number of days is automatically deleted. The default value is defined in the **Data Retention Settings** page.
- *Raw Journal Data*. Number of days to retain raw collected data from Dynamic Applications of type "journal". The default value is defined in the **Data Retention Settings** page.
- *Crunched Journal Data*. Number of days to retain data that has been processed using the presentation objects in Dynamic Applications of type "journal". The default value is defined in the **Data Retention Settings** page.
- *Configuration Data*. Number of days to retain data from Dynamic Applications of type "configuration". The default value is defined in the **Data Retention Settings** page.

**NOTE:** In SL1, normalized data does not include polling sessions that were missed or skipped. So for normalized data, null values are not included when calculating maximum values, minimum values, or average values.

**TIP:** You might want to retain normalized data for longer periods of time and non-normalized data for shorter periods of time. This allows you to save space and still create historical reports.

- **Counter Rollover Thresholds.** You can define the following two thresholds for the counters on the device. The thresholds defined for the device in this page override the global thresholds defined in the **Global Threshold Settings** page (System > Settings > Thresholds).
  - *Rollover Percent.* For any collected data that uses a 32-bit counter, you can specify how SL1 determines that the counter has "rolled over", that is, has reached its maximum value, is reset to zero, and restarts counting. When this happens, the collected values go from the maximum value to a lower value. However, there are multiple circumstances under which a 32-bit counter value can go from a higher value to a lower value:

**NOTE:** For 64-bit counters, when the counter values go from a higher value to a lower value, SL1 assumes that the counter has been manually reset or that the two values were collected out of order. SL1 does not assume that the counter has rolled over.

- Maximum value has been exceeded and counter was reset to zero.
- Data was collected out-of-order, that is, due to a slowdown somewhere in the network, two counter values were stored out of sequence.
- Retrieved value was manually reset to zero on the external device.

The **Rollover Percent** field allows you to specify a threshold that indicates that a 32-bit counter has reached its maximum value and restarted counting. The default value is 20%. When SL1 records a counter value from a 32-bit counter that is lower than the previously collected value, SL1:

- calculates the difference between the two counter values (the delta):

$$\text{maximum value (either } 2^{32}\text{)} - \text{Last Collected Value} + \text{Current Collected Value}$$

- Examines the value of the **Rollover Percent** threshold. If the delta is less than the specified percentage of the maximum possible value (either  $2^{32}$ ), SL1 concludes that the counter rolled over.
- For example, if you specified "25" in this field, SL1 would determine if the delta is less than 25% of the maximum possible value. If the delta is less than 25% of the maximum possible value, SL1 concludes that the counter rolled over.
- When SL1 determines a 32-bit counter has rolled over, SL1 uses the delta value when displaying the data point for this poll period.

- *Out-of-order Percent*. For any collected data that uses a counter, you can specify how SL1 determines that data has been collected out of order. When this data is collected out of order, the collected values go from a higher value to a lower value. However, there are multiple circumstances under which a counter value can go from a higher value to a lower value.
  - Maximum value has been exceeded and counter was reset to zero (for 32-bit counters only).
  - Data was collected out-of-order, that is, due to a slowdown somewhere in the network, two counter values were stored out of sequence.
  - Retrieved value was manually reset to zero on the external device.

The **Out-of-order Percent** field allows you to specify a threshold that indicates that data has been collected out of order. The default value is 50%. When SL1 records a counter value that is lower than the previously collected value and SL1 has determined that the value is not a rollover, SL1:

- compares the current value to the last collected value:

$$\text{current value} / \text{last collected value}$$

- If the ratio of current value / last collected value is greater than the percent specified in the **Out-of-order Percent** field, SL1 concludes that the data was collected out of order.
- When SL1 determines a data point has been collected out of order, SL1 uses the following value as the current value of the data point:

$$\text{last collected value} - \text{current collected value}$$

**NOTE:** If a 32-bit counter value goes from the maximum value to a lower value, and the current collected value does not meet the criteria for a rollover AND the current collected value does not meet the criteria for out-of-order, SL1 concludes that the 32-bit counter was manually reset to zero (0). SL1 uses the current collected value for this data point.

**NOTE:** If a 64-bit counter value goes from a higher value to a lower value, and the current collected value does not meet the criteria for out-of-order, SL1 concludes that the 64-bit counter was manually reset to zero (0). SL1 uses the current collected value for this data point.

- **ICMP Availability Thresholds**. You can define the following availability thresholds for the device. The thresholds defined for the device in this page override the global thresholds defined in the **Global Threshold Settings** page (System > Settings > Thresholds).
  - *Availability Ping Count*. If you selected *ICMP* in the **Availability Port** field on the **[Settings]** tab of the **Device Investigator** (or on the **Device Properties** page in the classic SL1 user interface), this field specifies the number of packets that should be sent during each availability check. If you selected *ICMP* in the **Latency Port** field in the **Device Properties** page, this field specifies the number of packets that should be sent during each latency check. The default value is "1".

- *Avail Required Ping Percentage*. If you selected *ICMP* in the **Availability Port** field on the **[Settings]** tab of the **Device Investigator** (or on the **Device Properties** page in the classic SL1 user interface), this field specifies the percentage of packets that must be returned during an availability check for SL1 to consider the device available. The default value is "100%".
- *Availability Packet Size*. If you selected *ICMP* in the **Availability Port** field on the **[Settings]** tab of the **Device Investigator** (or on the **Device Properties** page in the classic SL1 user interface), this field specifies the size of each packet, in bytes, that is sent during each availability check. If you selected *ICMP* in the **Latency Port** field in the **Device Properties** page, this field specifies the size of each packet, in bytes, that is sent during each latency check. The default value is "56 bytes".
- **Component Device Thresholds**. You can define the following thresholds for component devices. The thresholds defined for the device in this page override the global thresholds defined in the **Global Threshold Settings** page (System > Settings > Thresholds).
  - *Component Vanish Timeout Mins*. If SL1 cannot retrieve information from a root device about a component device, this field specifies how many minutes to wait until putting the component device into "vanish" mode. When a device is set to "vanished", SL1 stops trying to collect data from the component device. The vanished device will not appear in reports or views. The vanished device will appear in the **Vanished Device Manager** page. If you set this value to "0", the component device is never set to "vanished". For the current device, this setting overrides the **Component Vanish Timeout** in the **Global Threshold Settings** page.
  - *Component Purge Timeout*. If SL1 cannot retrieve information from a root device about a component device, this field specifies how many hours to wait until purging the component device. When a device is purged, SL1 stops trying to collect data from the component device. The purged device will not appear in reports or views on in any pages in the user interface. When a device is purged, all of its configuration data and collected data is deleted from the Database Server. If you set this value to "0", the component device is never purged. For the current device, this setting overrides the **Component Purge Timeout** in the **Global Threshold Settings** page.

**NOTE:** When a device is set to "vanished", all children of that device are also set to "vanished". When a device is purged, all children of that device are also purged.

3. Click **[Save]**.

**NOTE:** If you have changed a threshold from its default value, you can return it to its default value by selecting the **Default** checkbox next to the appropriate field and then clicking **[Save]**.

## Defining Device Thresholds in the Classic SL1 User Interface

The **Device Thresholds** page allows you to define space and performance thresholds for a device. When performance thresholds are exceeded, SL1 will generate an event for the device. When space thresholds are exceeded, SL1 will remove the oldest data from the database. For each of these thresholds, SL1 defines a default value. You can edit the thresholds to meet your needs.

The thresholds defined for the device in the **Device Thresholds** page override the global thresholds defined in the **Global Threshold Settings** page (System > Settings > Thresholds) and the **Data Retention Settings** page (System > Settings > Data Retention).

To define thresholds for a device:

1. Go to the **Device Manager** page (Devices > Device Manager).
2. On the **Device Manager** page, find the device for which you want to define thresholds and click its wrench icon ().

Device Manager   Devices Found (176)											Actions		Report	Reset	Guide
Device Name	IP Address	Device Category	Device Class   Subclass	OID	Organization	Current State	Collection Group	Collection Status	SNMP Credentials	SNMP Version					
server-651	10.20.0.177	Office Printers	Lexmark International   Print Server	42	System	Minor	CUG1	Active	Cisco SNMPv2 - Exa V2	2					
StorageSwitch	10.20.0.214	Unknown	Shoreline Teleworks   OEM	15	System	Healthy	CUG1	Active	Cisco SNMPv2 - Exa V2	2					
SimpleSRV.ca.ScienceLogic.local	10.20.0.7	Servers	Microsoft   Windows Server 2008 R2	77	System	Minor	CUG1	Active	pb8m5a V2	2					
SNAP662146	10.20.0.249	Storage NAS	Quantum Corp - Snap Division   Snap Server	158	System	Minor	CUG1	Active	Cisco SNMPv2 - Exa V2	2					
SNS-PRX-IDC1-Texas	10.20.0.247	Network Switches	Juniper Networks   M71 Router	152	System	Healthy	CUG1	Active	Cisco SNMPv2 - Exa V2	2					
SOM2353DX	10.20.0.188	Servers	Microsoft   Windows CE Version 3.0 (Multiple	27	System	Healthy	CUG1	Active	Cisco SNMPv2 - Exa V2	2					
Somni-1	10.20.0.92	Network Switches	Enterprise Networks   Summit400 Version 7.1.1	191	System	Healthy	CUG1	Active	Cisco SNMPv2 - Exa V2	2					
sunprod1	10.20.0.27	Servers	NET-SNMP   Solaris	169	System	Major	CUG1	Active	Cisco SNMPv2 - Exa V2	2					
Suven_MonmouthJunctUSA	10.20.0.210	Telephony	Quantum   Tenor A800	18	System	Healthy	CUG1	Active	Cisco SNMPv2 - Exa V2	2					
SW275DR4C1_NewDA	10.20.0.1	Network Switches	Cisco Systems   Catalyst 3750-Stack	76	System	Healthy	CUG1	Active	Cisco SNMPv2 - Exa V2	2					
swach	10.20.0.15	Network Switches	Brocade   ChannelAL Switch	164	System	Healthy	CUG1	Active	Cisco SNMPv2 - Exa V2	2					
tanberg	10.20.0.217	Unknown	Tanberg ASA   OEM	12	System	Healthy	CUG1	Active	Cisco SNMPv2 - Exa V2	2					
tgernskic-fw0.ra1.hostedsolutions.com	10.20.0.157	Network Firewall	Cisco Systems   ASA 5520	146	System	Minor	CUG1	Active	Cisco SNMPv2 - Exa V2	2					
TOSHIBA-e-STUDIO451c	10.20.0.86	Unknown	Tec Corporation   OEM	124	System	Minor	CUG1	Active	Cisco SNMPv2 - Exa V2	2					
ttccomm	10.20.0.229	Unknown	Xerox   OEM	81	System	Minor	CUG1	Active	Cisco SNMPv2 - Exa V2	2					
ts2.local	10.20.0.71	Network Switches	Cisco Systems   TS SEC	65	System	Healthy	CUG1	Active	Cisco SNMPv2 - Exa V2	2					
ts3.local	10.20.0.72	Network Switches	Cisco Systems   TS SEC	67	System	Healthy	CUG1	Active	Cisco SNMPv2 - Exa V2	2					
TULLPT15-ACCOUNTING	10.20.0.168	Unknown	HPI   OEM	166	System	Minor	CUG1	Active	Cisco SNMPv2 - Exa V2	2					
upst1.tvmz	10.20.0.77	Environmental UPS	APC   SmartUPS 2200	66	System	Critical	CUG1	Active	Cisco SNMPv2 - Exa V2	2					
UT1000	10.20.0.166	Unknown	General Instrument   OEM	55	System	Healthy	CUG1	Active	Cisco SNMPv2 - Exa V2	2					
vxtarget	10.20.0.227	Telephony	Vina Technologies   Multiplexor	136	System	Healthy	CUG1	Active	Cisco SNMPv2 - Exa V2	2					
webdb-prod1	10.20.0.64	Servers	Empire Technologies   Default Enterprise Agent	87	System	Critical	CUG1	Active	Cisco SNMPv2 - Exa V2	2					
WILLIAMS-CORE-R01	10.20.0.82	Network Router	Cisco Systems   1750	83	System	Minor	CUG1	Active	Cisco SNMPv2 - Exa V2	2					
WIX0005-IT_Watchdogs, Inc.	10.20.0.226	Unknown	Generic   DMPP	78	System	Healthy	CUG1	Active	Cisco SNMPv2 - Exa V2	2					
wx0005v134	10.20.0.23	Servers	XenServer   Xen Host	176	System	Healthy	CUG1	Active	Cisco SNMPv2 - Exa V2	2					

- In the **Device Administration** panel, click the **[Thresholds]** tab.

The screenshot shows the 'Device Administration' panel with the 'Thresholds' tab selected. The device information at the top includes:

- Device Name: WIN-RA4KHSMQG59
- IP Address / ID: 10.2.9.18 | 1471
- Class: Microsoft
- Organization: SAC\_Sanity\_Group\_Test
- Collection Mode: Active
- Description: Hardware: Intel®4 Family 6 Model 63 Stepping 2 AT/AT COMPATIBLE -
- Device Hostname: WIN-RA4KHSMQG59
- Managed Type: Physical Device
- Category: Servers
- Sub-Class: Windows Server 2012 R2
- Uptime: 0 days, 15:32:09
- Collection Time: 2017-08-25 13:40:00
- Group / Collector: CUG-Core2-COSS-mysql56 | 10-64-170-43\_cu\_core2\_mysql56

The 'Device Thresholds' section is divided into three categories:

- Dynamic App Thresholds | Host Resource: Configuration**
  - Raw Data Retention: 7 records (Default: 7)
- Dynamic App Thresholds | Host Resource: CPU**
  - CPU Utilization High: 90% (Default: 90)
  - Raw Data Retention: 7 days (Default: 7)
  - Hourly Rollup Retention: 120 days (Default: 120)
  - Daily Rollup Retention: 730 days (Default: 730)
- Dynamic App Thresholds | Host Resource: Memory**
  - Swap Memory Utilization High: 60% (Default: 60)
  - Physical Memory Utilization High: 80% (Default: 80)
  - Raw Data Retention: 7 days (Default: 7)
  - Hourly Rollup Retention: 120 days (Default: 120)
  - Daily Rollup Retention: 730 days (Default: 730)

Each threshold setting includes a slider, an input field, and a checkbox for the default value. A 'Save' button is located below each category.

- In the **Device Thresholds** page, define one or more of the thresholds. For a description of the threshold fields, see the section on [Device Thresholds](#).
- Click the **[Save]** button to save your changes.



## Bulk Management with Device Groups and Device Templates

---

### Overview

This chapter provides an overview of the device groups and device template features. For more information on how to use and manage device groups and device templates, see the *Device Groups & Device Templates* manual.

Use the following menu options to navigate the SL1 user interface:

- To view a pop-out list of menu options, click the menu icon (.
- To view a page containing all of the menu options, click the Advanced menu icon (.

This chapter includes the following topics:

<a href="#">What is a Device Group?</a> .....	264
<a href="#">What is a Device Template?</a> .....	266

---

### What is a Device Group?

A *device group* is a group of multiple devices.



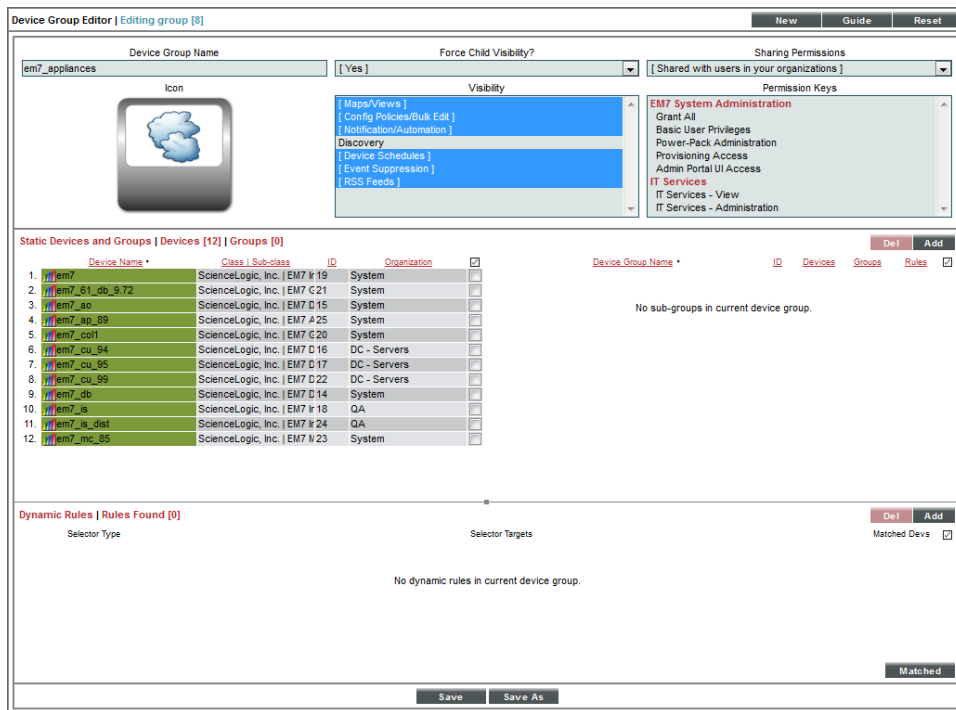

Device groups allow you to:

- Use device configuration templates to perform initial configuration for multiple devices simultaneously.
- Use device configuration templates to make changes to the configuration for multiple devices simultaneously.
- In Devices > Device Groups, view each device group and the sub-groups and devices within each device group.
- Schedule maintenance and downtime for multiple devices simultaneously.
- Suppress events on multiple devices simultaneously.
- Include the device group in an automation policy. An automation policy allows you to trigger an automatic action if specified criteria are met on all the devices in the device group.

A device can belong to multiple device groups. For example, suppose SL1 discovered a server. Suppose this server hosts a corporate website that you want to monitor with a web-content policy. Suppose this server also hosts a MySQL database that you want to monitor with a Dynamic Application for MySQL. You could make this server a member of two device groups, one device group for web servers and another device group for MySQL databases. You could then use a device configuration template to apply a web-content policy to all devices in the device group for web servers and another device configuration template to apply a Dynamic Application for MySQL to all devices in the device group for MySQL servers.

You can add devices to a device group either explicitly or dynamically.

- You can create **static device groups**, where you explicitly assign one or more devices to a device group.
- You can create **dynamic device groups**, where you define **rules** for the device group. Each device that meets the criteria in the rule is automatically included in the device group. For example, suppose that you define a rule that specifies "include all devices in the *System* organization, with an IP address that starts with '10.100.100' ". SL1 would automatically assign all devices from the *System* organization with an IP of "10.100.100.\*" to the new device group. When a new device is added to the *System* organization with an IP that begins with "10.100.100.\*", that device will also be included in the device group. If a device with an IP that starts with "10.100.100.\*" is removed from the *System* organization, that device will also be removed from the device group.
- You can create a device group that includes both explicitly assigned devices and also includes a dynamic rule. This device group will include both the explicitly assigned devices and all devices that meet the criteria in the dynamic rule.

The IT Services feature in SL1 uses device groups to define an IT Service. An IT Service contains sets of rules that define the state of that IT Service based on the state of the devices within the device group. For example, if you created an IT Service that represents the state of your Email service, the associated device group might contain your DNS Servers, Exchange Servers, and Virtual Devices that are associated with Email Round-Trip Policies. To learn more about IT Services, see the **IT Services** manual.

## What is a Device Template?

**Device templates** allow you to save a device configuration, apply it to one or more devices, and re-use the same configuration over and over again.

The screenshot shows the 'Device Template Editor' interface for a template named 'Bryan\_Dynatrace Template'. The interface is divided into several sections:

- Config Tab:** Contains sub-sections for 'Access & Monitoring' (Device Organization: Acme Inc, SNMP Read: Cisco SNMPv2 - Example, Availability Protocol: TCP, Latency Protocol: TCP, Avail+Latency Alert: Disabled, Collection: Enabled, Coll. Type: Standard, Critical Ping: Disabled, Event Mask: Disabled), 'Device Preferences' (Auto-Clear Events, Scan All IPs, Accept All Logs, Dynamic Discovery, Daily Port Scans, Preserve Hostname, Auto-Update, Disable Asset Update, Bypass Interface Inventory), 'Device Retention & Basic Thresholds' (System Latency: 100 ms, Availability Packet Size: 56 bytes, Availability Ping Count: 1 pings, Daily Rollup Bandwidth Data: 730 days, Hourly Rollup Bandwidth Data: 120 days, Raw Performance Data: 7 days, Daily Rollup Performance Data: 730 days), and 'Interface Inventory Settings' (Interface Inventory Timeout: 600000 ms, Maximum Allowed Interfaces: 10000).
- Other Tabs:** Interface, CV Policies, Port Policies, Svc Policies, Proc Policies, Dyn Apps, and Logs.

Buttons for 'New', 'Reset', 'Save', and 'Save As' are visible at the bottom of the interface.

A device template contains the following tabs and settings:

- **[Config]** tab. Contains all the fields in the **Device Properties** page (except device name and device IP) and all the fields in the **Device Thresholds** page. When you apply a device template to a device group or selected devices, you do not have to manually define any settings in the **Device Properties** page or the **Device Thresholds** page for the devices that use the template. All the devices that use the template will inherit the field values from the device template.
- **[Interface]** tab. Contains all the fields in the **Interface Properties** page that define how SL1 will monitor one or more network interfaces and the thresholds for those network interfaces. When you apply a device template to a device group or selected devices, you do not have to manually define any settings in the **Interface Properties** page for the devices that use the template. All the devices that use the template will inherit the field values from the device template.
- **[CV Policies]** tab. Specifies one or more web-content policies that can be applied to all devices that use the template. These web-content policies enable SL1 to monitor a website. SL1 will periodically check the website for specified content. If the content cannot be found on the website, SL1 will generate an event. When you apply a device template to a device, you do not have to manually define any web-content and availability policies in the **Monitoring Policies** page for the devices. All the devices that use the template will inherit the web-content policies from the device template; SL1 will automatically create these web-content policies for each device that uses the template.
- **[Port Policies]** tab. Specifies one or more TCP/IP Port policies that can be applied to all member devices. These TCP/IP Port policies tell SL1 to monitor a specified port for availability every five minutes. Availability refers to the port's ability to accept connections and data. When you apply a device template to a device group, you do not have to manually define any TCP/IP port policies in the **Monitoring Policies** page for the member devices. All the devices in the device group will inherit the TCP/IP port policies from the device template; SL1 will automatically create these port policies for each device that uses the template.
- **[Svc Policies]** tab. Specifies one or more Windows service policies that can be applied to devices that use the template. These Windows services policies tell SL1 to monitor the device and look for the specified service. You can define a service policy so that SL1 monitors whether or not the service is running and then performs an action (starts, pauses, or restarts the service, reboots or shuts down the device, triggers the execution of a remote script or program). When you apply a device template to devices, you do not have to manually define any Windows service policies in the **Monitoring Policies** page for those devices. All the devices that use the template will inherit the Windows service policies from the device template; SL1 will automatically create these Windows service policies for each device that uses the template.

**NOTE:** In addition to using a Windows Service policy, SL1 includes a PowerPack called "Windows Restart Automatic Services". This PowerPack includes a Dynamic Application that monitors Windows Services with a mode of "Automatic". This PowerPack also includes two events and a Run Book policy. If the Dynamic Application reports that a Windows Service with a mode of "Automatic" has stopped running, SL1 generates an event and the Run Book policy automatically restarts the Windows Service.

- **[Proc Policies]** tab. Specifies one or more Process policies that can be applied to devices that use the template. These Process policies tell SL1 to monitor the device and look for the process. You can define a process policy so that SL1 monitors whether or not the process is running and optionally, how much memory a process can use and how many instances of a process can run simultaneously. When you apply a device template to devices, you do not have to manually define any Process policies in the **Monitoring Policies** page for those devices. All the devices that use the device template will inherit the Process policies from the device template; SL1 will automatically create these process policies for each device that uses the template.

- **[Dynamic Apps]** tab. Specifies one or more Dynamic Applications that can be aligned with devices that use the template. SL1 will use the specified Dynamic Applications to retrieve data from the devices that use the template. (Note that each device that uses the template might also be aligned with additional Dynamic Applications that have been aligned with the device in other ways: for example, from the automatic alignment that occurs during discovery.) When you apply a device template to devices, you do not manually have to align Dynamic Applications in the **Dynamic Application Collections** page for those devices. All devices that use the device template will be aligned with the Dynamic Applications specified in the device template.
  - If you select a Dynamic Application in a Device Template, and that Dynamic Application has associated thresholds, you can change one or more of those thresholds from the Device Template. The thresholds you specify in the Device Template will override the thresholds defined in the Dynamic Application. When you apply a device template to devices, you do not manually have to edit the Dynamic Application Thresholds in the **Device Thresholds** page for those devices. All devices that use the device template will inherit the Dynamic Application Thresholds specified in the device template.

**NOTE:** In a configuration template, you are not required to define all the fields in each tab. For example, you can choose to define only one or more fields in only one tab. When you apply the configuration template to devices, only those fields you defined in the template will be applied to the devices. For the remaining fields, the devices will retain their previous values or use the default values.

You can apply device templates to:

- One or more **device groups**.
- One or more devices, selected from the **Device Manager** page.
- all the devices discovered by a specific discovery session.

You can also apply device templates to automate the initial configuration of multiple devices. If you change a device template, you can use it to automate the editing of the configuration of multiple devices.

**Device templates are not dynamic.** That is, when you update or change a device template, no changes are made to any devices that have used the template in the past.

You can make temporary changes to a device template, apply the template to a devices, and then exit the device template without saving the temporary changes. In this way, you can apply settings to a device group but not permanently save the settings in the device template.

**NOTE:** If you make changes to a device template or simply apply the device template a second time, SL1 will not create duplicate policies on the member devices. However, if you edit a device template and make a change to a policy, the policy will be updated on the member devices.

---

# Chapter

# 13



## Virtual Devices

---

### Overview

This chapter describes how to create and use virtual devices in SL1 .

Use the following menu options to navigate the SL1 user interface:

- To view a pop-out list of menu options, click the menu icon ().
- To view a page containing all of the menu options, click the Advanced menu icon (  ).

This chapter includes the following topics:

<i>What is a Virtual Device?</i> .....	269
<i>Defining a Virtual Device</i> .....	270
<i>Directing Data to a Virtual Device</i> .....	271
<i>Redirecting Log Data to a Virtual Device</i> .....	272
<i>Aligning a Dynamic Application with a Virtual Device</i> .....	274

---

### What is a Virtual Device?

A **virtual device** is a container for collected data. A virtual device can be used when you want to:

- Monitor a device or application that doesn't support TCP/IP, SNMP, or both. The device's data can be pushed to SL1 via another method (for example, email) and stored in a virtual device.

- Monitor multiple SNMP agents on a single device. In such a case, one of the SNMP agents (for example, a hardware agent) can be associated with the device and another SNMP agent (for example, an agent that monitors a software application) can be associated with a virtual device.
- Isolate and monitor specific parameters separately from their originating device. For example, you might want to monitor a database and keep its data separate from the hardware data you are collecting from the host device.

## Defining a Virtual Device

To create a virtual device, you must complete the following tasks:

1. Ensure that SL1 includes a device class for virtual devices. These device classes must have a device category of "virtual" and a collection type of "virtual". If SL1 does not include such a device class, you must [define one](#) in the **Device Class Editor** page (System > Customize > Device Classes).
2. Go to the **Device Manager** page (Devices > Device Manager).

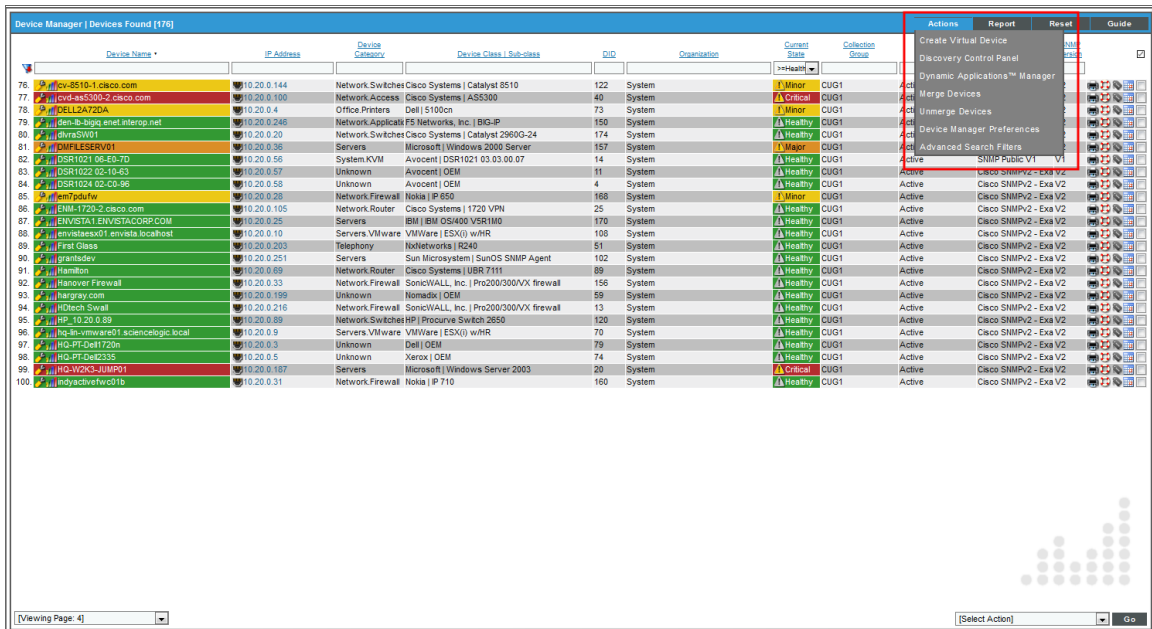

3. From the **[Actions]** menu, select *Create Virtual Device*.

- The **Create Virtual Device** modal appears.

The screenshot shows a modal window titled "Virtual Device" with a red header bar. Inside the modal, there is a sub-header "Create Virtual Device" and a "Reset" button. Below this, there are four input fields: "Device Name" (text input with "virtual\_webcontent\_1"), "Organization" (dropdown menu with "System"), "Device Class" (dropdown menu with "Virtual Device | Content Verification"), and "Collector" (dropdown menu with "CUG"). At the bottom of the modal is a large "Add" button.

- Supply a value in each of the following fields:
  - Device Name.** Name of the virtual device. Can be any combination of alphanumeric characters, up to 32 characters in length.
  - Organization.** Organization to associate with the virtual device. Select from the drop-down list of all organizations in SL1 .
  - Device Class.** The device class to associate with the virtual device. Select from the drop-down list of device classes. Only device classes with a device category of "virtual" and a collection type of "virtual" appear in the list.
  - Collector.** Specifies which instance of SL1 will perform auto-discovery and gather data from the device. Can also specify a "virtual" poller. Select from the drop-down list of all collectors in SL1 .
- Select the **[Add]** button to save the new virtual device.
- You must now define the data to store in the virtual device.

---

## Directing Data to a Virtual Device

After defining a virtual device, you must tell SL1 which data to store in the virtual device.

- For data that is pushed to SL1 , go to the **Redirect Policy Editor** page for the virtual device (Devices > Device Manager), find virtual device, select its wrench icon [  ], and then select the **[Redirects]** tab). Define the log data you want to collect and associate with the virtual device.

- For data that is collected via SNMP or TCP/IP, go to the **Dynamic Application Collections** page for the virtual device (Devices > Device Manager), find the virtual device, select its wrench icon [  ], and then select the **[Collections]** tab). Manually associate a Dynamic Application with the device. This ensures that data collected by the Dynamic Application is stored in the virtual device.

## Redirecting Log Data to a Virtual Device

The **Redirect Policy Editor** is most useful for devices that don't support TCP/IP. For these devices, data can be pushed from the device to another device that does support TCP/IP. SL1 can then collect the data from the device that does support TCP/IP. You can create a virtual device in SL1 to represent the device that doesn't support TCP/IP. You can then move the data from the TCP/IP device that is monitored by SL1 to the virtual device in SL1. The **Redirect Policy Editor** page allows you to move data from the TCP/IP device to the virtual device. The **Redirect Policy Editor** page allows you to move log entries generated by inbound SNMP Trap, Syslog, or Email messages from the TCP/IP device to the virtual device.

- Log entries that are redirected to a virtual device will no longer appear in the log files for the IP-based device.
- Log entries that are redirected to a virtual device are no longer associated with the IP address of the original device.
- Log entries with a **Source** of *Internal*, *Dynamic*, or *API* that match a redirect policy are not moved from the IP-based device to the current device.

To redirect data from a TCP/IP device to a virtual device:

- Go to the **Device Manager** page (Devices > Device Manager).
- In the **Device Manager** page, find the virtual device to which you want to redirect data. Select its wrench icon [  ].

Device Manager   Devices Found [176]										Actions		Report	Reset	Guide	
Device Name	IP Address	Device Category	Device Class   Subclass	OID	Organization	Current State	Collection Group	Collection State	SNMP Credential	SNMP Version					
151	10.20.0.177	Office Printers	Lexmark International   Print Server	42	System	Minor	CUG1	Active	Cisco SNMPv2 - Exa V2	2					
152	10.20.0.214	Unknown	Shoreline Teleworks   OEM	15	System	Healthy	CUG1	Active	Cisco SNMPv2 - Exa V2	2					
153	10.20.0.7	Servers	Microsoft   Windows Server 2008 R2	77	System	Minor	CUG1	Active	cbasm5 V2	2					
154	10.20.0.249	Storage.NAS	Quantum Corp - Snap Division   Snap Server	158	System	Minor	CUG1	Active	Cisco SNMPv2 - Exa V2	2					
155	10.20.0.247	Network.Switches	Juniper Networks   M71 Router	152	System	Healthy	CUG1	Active	Cisco SNMPv2 - Exa V2	2					
156	10.20.0.183	Servers	Microsoft   Windows CC Version 3.0 (Multiple	27	System	Healthy	CUG1	Active	Cisco SNMPv2 - Exa V2	2					
157	10.20.0.92	Network.Switches	Extreme Networks   Summit46s Version 7.1.1	101	System	Healthy	CUG1	Active	Cisco SNMPv2 - Exa V2	2					
158	10.20.0.27	Servers	NET-SNMP   Solaris	169	System	Major	CUG1	Active	Cisco SNMPv2 - Exa V2	2					
159	10.20.0.210	Telephony	Quantum   Tenor AB00	18	System	Healthy	CUG1	Active	Cisco SNMPv2 - Exa V2	2					
160	10.20.0.1	Network.Switches	Cisco Systems   Catalyst 3750-Slack	78	System	Healthy	CUG1	Active	Cisco SNMPv2 - Exa V2	2					
161	10.20.0.15	Network.Switches	Brocade   Chameleon Switch	164	System	Healthy	CUG1	Active	Cisco SNMPv2 - Exa V2	2					
162	10.20.0.217	Unknown	Tandberg ASA   OEM	12	System	Healthy	CUG1	Active	Cisco SNMPv2 - Exa V2	2					
163	10.20.0.157	Network.Firewall	Cisco Systems   ASA 5520	146	System	Minor	CUG1	Active	Cisco SNMPv2 - Exa V2	2					
164	10.20.0.86	Unknown	Tec Corporation   OEM	124	System	Minor	CUG1	Active	Cisco SNMPv2 - Exa V2	2					
165	10.20.0.229	Unknown	Xerox   OEM	81	System	Minor	CUG1	Active	Cisco SNMPv2 - Exa V2	2					
166	10.20.0.71	Network.Switches	Cisco Systems   TS SEC	68	System	Healthy	CUG1	Active	Cisco SNMPv2 - Exa V2	2					
167	10.20.0.72	Network.Switches	Cisco Systems   TS SEC	67	System	Healthy	CUG1	Active	Cisco SNMPv2 - Exa V2	2					
168	10.20.0.168	Unknown	HP   OEM	166	System	Minor	CUG1	Active	Cisco SNMPv2 - Exa V2	2					
169	10.20.0.77	Environmental.UPLCI	SmartUPS 2200	66	System	Critical	CUG1	Active	Cisco SNMPv2 - Exa V2	2					
170	10.20.0.166	Unknown	General Instrument   OEM	55	System	Healthy	CUG1	Active	Cisco SNMPv2 - Exa V2	2					
171	10.20.0.227	Telephony	Vina Technologies   Multiplexor	136	System	Healthy	CUG1	Active	Cisco SNMPv2 - Exa V2	2					
172	10.20.0.64	Servers	Empire Technologies   Default Enterprise Agent	87	System	Critical	CUG1	Active	Cisco SNMPv2 - Exa V2	2					
173	10.20.0.62	Network.Router	Cisco Systems   1750	83	System	Minor	CUG1	Active	Cisco SNMPv2 - Exa V2	2					
174	10.20.0.228	Unknown	Genesys   SNMP	76	System	Healthy	CUG1	Active	Cisco SNMPv2 - Exa V2	2					
175	10.20.0.23	Servers	XenServer   Xen Host	176	System	Healthy	CUG1	Active	Cisco SNMPv2 - Exa V2	2					



- In the **Device Administration** panel, select the **[Redirects]** tab.

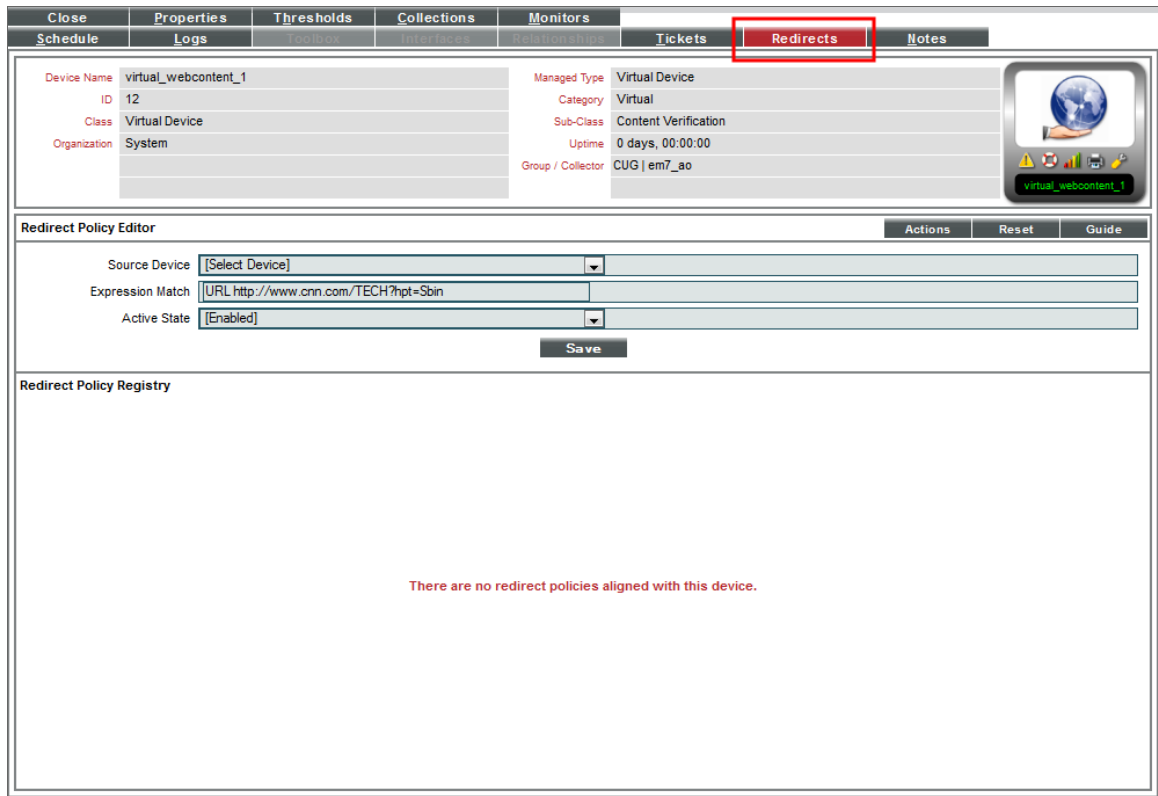

- To move SNMP Trap, Syslog, or Email log messages from an IP-based device to the current device, provide values in each of the following fields:
  - **Source Device.** This is the TCP/IP device from which you want to redirect log messages. Data from this device will be moved to the virtual device. Select from a drop-down list of all IP-based devices discovered by SL1.
  - **Expression Match.** A regular expression used to locate the log entry to redirect. Can be any combination of alphanumeric and multi-byte characters, up to 64 characters in length. SL1's expression matching is case-sensitive. For details on the regular-expression syntax allowed by SL1, see <http://www.python.org/doc/howto/>.
  - **Active State.** Specifies whether or not SL1 will execute the redirection policy. The choices are:
    - *Enable.* SL1 will execute the redirection policy.
    - *Disable.* SL1 will not execute the redirection policy.
- Select the **[Save]** button.
- You can repeat Step 4 and Step 5 to redirect data to the virtual device from more than one device or from more than one type of log message.

## Aligning a Dynamic Application with a Virtual Device

For data that is collected via Dynamic Application, you can associate that data with a virtual device. The data collected by the Dynamic Application will be stored in the virtual device.

**NOTE:** You cannot align SNMP Dynamic Applications with a virtual device. You can align all other types of Dynamic Applications with a virtual device.

To manually associate a Dynamic Application with a device:

1. Go to the **Device Manager** page (Devices > Device Manager).
2. In the **Device Manager** page, find the device you want to associate with a Dynamic Application. Click its wrench icon (🔧).
3. In the **Device Administration** panel, click the **[Collections]** tab.
4. In the **Dynamic Application Collections** page, click the **[Action]** menu and select *Add Dynamic Application*.

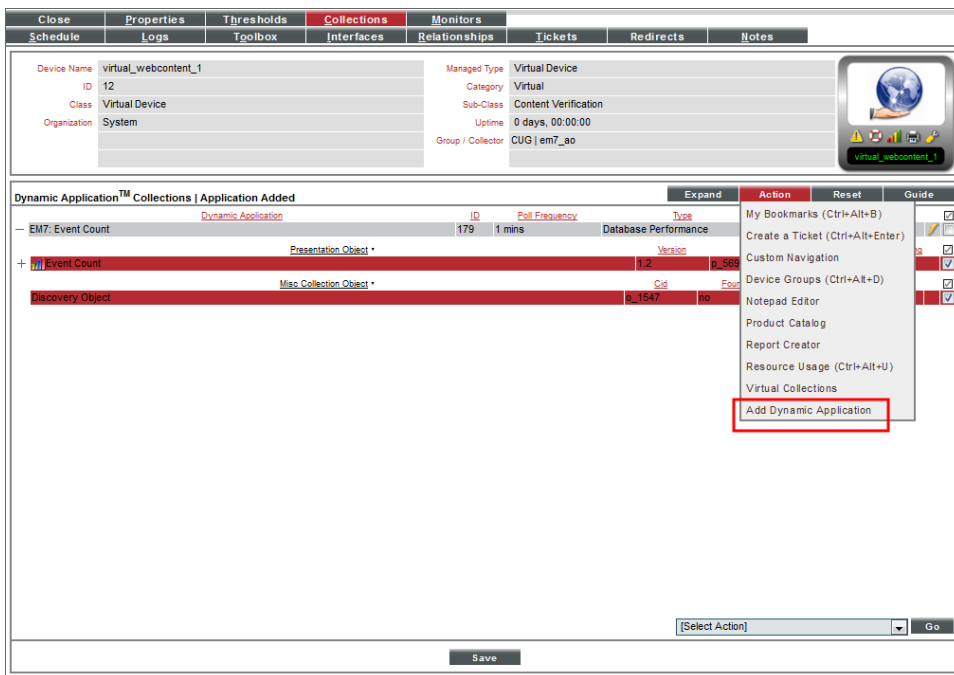

5. The **Dynamic Application Alignment** modal page appears.

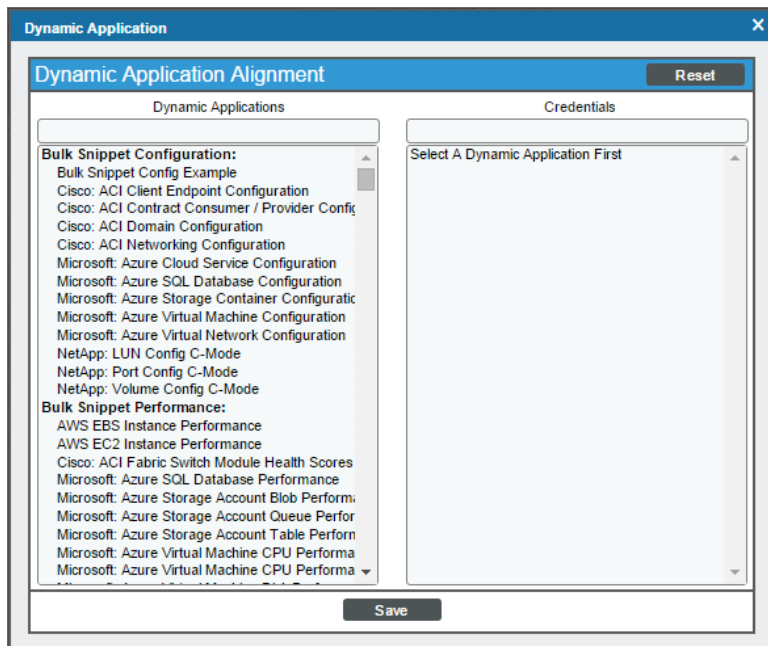

6. To associate an additional Dynamic Application with the device, highlight it in the **Dynamic Applications** field. You can filter the list of Dynamic Applications using the search field above the **Dynamic Applications** field.
7. After selection a Dynamic Application, you must select a credential. Select a credential in the **Credentials** field. You can filter the list of credentials using the search field above the **Credentials** field.

**NOTE:** Your organization membership(s) might affect the list of credentials you can see in the **Credentials** field.

8. Click the **[Save]** button in the **Dynamic Application Alignment** modal page to align the Dynamic Application and the credential to the device.
9. SL1 will associate the Dynamic Application with the device and immediately attempt to collect the data specified in the Dynamic Application using the selected credential.
10. After the first, immediate collection, SL1 will collect the data at the frequency defined in the **Polling Frequency** field in the **Application Configuration Editor** page for the Dynamic Application.



## Customizing the User Interface for a Device

---

### Overview

This chapter describes how to define custom tabs in the **Device Administration** panel for a specific device.

Use the following menu options to navigate the SL1 user interface:

- To view a pop-out list of menu options, click the menu icon ().
- To view a page containing all of the menu options, click the Advanced menu icon ().

This chapter includes the following topics:

<a href="#">Custom Navigation</a> .....	276
<a href="#">Editing a Custom Navigation tab</a> .....	278

---

### Custom Navigation

In the **Device Administration** panel you can access the **Custom Navigation** modal page.

The **Custom Navigation** modal page allows users to define custom tabs to include in the **Device Administration** panel for a specific device. Each custom tab includes one or more links. The links can be to internal pages in SL1 or external URLs and URIs.

To define a custom tab for a device:

1. Go to the **Device Manager** page (Devices > Device Manager).

- In the **Device Manager** page, find the device for which you want to create a custom tab. Select its wrench icon ().

Device Manager   Devices Found [178]											Actions	Report	Reset	Guide
Device Name	IP Address	Device Category	Device Class   Sub-class	OID	Organization	Guest State	Collection Group	Collection State	SNMP Credentials	SNMP Version				
server-651	10.20.0.177	Office Printers	Lexmark International   Print Server	42	System	Minor	CUG1	Active	Cisco SNMPv2 - Exa V2	2.0				
ShorelineSwitch	10.20.0.214	Unknown	Shoreline Networks   OEM	15	System	Healthy	CUG1	Active	Cisco SNMPv2 - Exa V2	2.0				
ServerSoft-uk-ScienceLogic-local	10.20.0.27	Servers	Microsoft   Windows Server 2008 R2	77	System	Minor	CUG1	Active	IBM	2.0				
SNAP82146	10.20.0.249	Storage NAS	Quantum Corp - Snap Division   Snap Server	158	System	Minor	CUG1	Active	Cisco SNMPv2 - Exa V2	2.0				
CNS-PRX-MDC1-Texas	10.20.0.247	Network Switches	Juniper Networks   M71 Router	152	System	Healthy	CUG1	Active	Cisco SNMPv2 - Exa V2	2.0				
COM235DX	10.20.0.188	Servers	Microsoft   Windows CE Version 3.0 (Multiple	27	System	Healthy	CUG1	Active	Cisco SNMPv2 - Exa V2	2.0				
Server1	10.20.0.92	Network Switches	Extreme Networks   Summit4000 Version 7.1.1	181	System	Healthy	CUG1	Active	Cisco SNMPv2 - Exa V2	2.0				
serverprod1	10.20.0.27	Servers	NET-SNMP   Solaris	169	System	Minor	CUG1	Active	Cisco SNMPv2 - Exa V2	2.0				
Server_MonmouthJuncdtISA	10.20.0.210	Telephony	Quantum   Temor A300	18	System	Healthy	CUG1	Active	Cisco SNMPv2 - Exa V2	2.0				
21225RACK1_newGA	10.20.0.11	Network Switches	Cisco Systems   Catalyst 3750-Stack	76	System	Healthy	CUG1	Active	Cisco SNMPv2 - Exa V2	2.0				
Switch	10.20.0.15	Network Switches	Brocade   Channel-A1 Switch	104	System	Healthy	CUG1	Active	Cisco SNMPv2 - Exa V2	2.0				
landberg	10.20.0.217	Unknown	Tandberg ASA   OEM	12	System	Healthy	CUG1	Active	Cisco SNMPv2 - Exa V2	2.0				
serverlab-ctrl-ml-heliosolutions.com	10.20.0.167	Network Firewall	Cisco Systems   ASA 5520	146	System	Minor	CUG1	Active	Cisco SNMPv2 - Exa V2	2.0				
OSIRIA-e-RTD0451C	10.20.0.98	Unknown	Tec Corporation   OEM	124	System	Minor	CUG1	Active	Cisco SNMPv2 - Exa V2	2.0				
ITComm	10.20.0.229	Unknown	Xerox   OEM	81	System	Minor	CUG1	Active	Cisco SNMPv2 - Exa V2	2.0				
ts2 local	10.20.0.71	Network Switches	Cisco Systems   ITS SEC	68	System	Healthy	CUG1	Active	Cisco SNMPv2 - Exa V2	2.0				
ts3 local	10.20.0.72	Network Switches	Cisco Systems   ITS SEC	67	System	Healthy	CUG1	Active	Cisco SNMPv2 - Exa V2	2.0				
TULLPTIS-ACCOUNTING	10.20.0.168	Unknown	HPI   OEM	166	System	Minor	CUG1	Active	Cisco SNMPv2 - Exa V2	2.0				
tsa1 twm az	10.20.0.77	Environmental UPS APC	SmartUPS 2200	66	System	Critical	CUG1	Active	Cisco SNMPv2 - Exa V2	2.0				
VT1002	10.20.0.166	Unknown	General Instrument   OEM	55	System	Healthy	CUG1	Active	Cisco SNMPv2 - Exa V2	2.0				
vt100net	10.20.0.227	Telephony	Vista Technologies   Multiplexor	136	System	Healthy	CUG1	Active	Cisco SNMPv2 - Exa V2	2.0				
web8-prod1	10.20.0.64	Servers	Empire Technologies   Default Enterprise Agent	87	System	Critical	CUG1	Active	Cisco SNMPv2 - Exa V2	2.0				
vt-LLPMS-CORE-RO1	10.20.0.92	Network Router	Cisco Systems   1750	83	System	Minor	CUG1	Active	Cisco SNMPv2 - Exa V2	2.0				
Windows-File-Server-13-Webchops, Inc.	10.20.0.228	Unknown	Generic   SNMP	78	System	Healthy	CUG1	Active	Cisco SNMPv2 - Exa V2	2.0				
xlserverv134	10.20.0.23	Servers	XenServer   Xen Host	176	System	Healthy	CUG1	Active	Cisco SNMPv2 - Exa V2	2.0				

- In any page in the **Device Administration** panel, select the **[Actions]** menu and choose *Custom Navigation*.

Close	Properties	Thresholds	Collections	Monitors	Schedule	Logs	Toolbox	Interfaces	Relationships	Tickets	Redirects	Notes
<div style="display: flex; justify-content: space-between;"> <div> <p>Device Name: 10.0.0.101</p> <p>IP Address / ID: 10.0.0.101   1766</p> <p>Class: Cisco Systems</p> <p>Organization: Intel</p> <p>Collection Mode: Active</p> <p>Description: Cisco Systems, Inc. WS-C2948G-GE-TX Cisco Catalyst Operating Sy</p> <p>Device Hostname:</p> </div> <div> <p>Managed Type: Physical Device</p> <p>Category: Network Switches</p> <p>Sub-Class: Catalyst 2948G-GE-TX</p> <p>Uptime: 393 days, 22:26:38</p> <p>Collection Time: 2014-06-16 15:45:00</p> <p>Group / Collector: CUG1   em7_cu1</p> </div> <div>  </div> </div>												
<div style="display: flex; justify-content: space-between;"> <div> <p><b>Device Properties</b></p> <p>Identification</p> <p>Device Name: <input type="text" value="10.0.0.101"/></p> <p>IP Address: <input type="text" value="10.0.0.101 - verified"/></p> <p>Organization: <input type="text" value="Intel"/></p> <p>Monitoring &amp; Management</p> <p>Device Class: <input type="text" value="Cisco Systems Catalyst 2948G-GE-TX"/></p> <p>SNMP Read/Write: <input type="text" value="Cisco SNMPv2 - Example"/> <input type="text" value="[None]"/></p> <p>Availability Port: <input type="text" value="UDP"/> <input type="text" value="[161 - SNMP]"/></p> <p>Latency Port: <input type="text" value="ICMP"/> <input type="text" value="[ICMP]"/></p> <p>Avail+Latency Alert: <input type="text" value="Disable"/></p> <p>User Maintenance: <input type="text" value="Disable"/> <input type="text" value="[Maintenance Collection Enabled]"/></p> <p>Collection: <input type="text" value="Enabled"/> <input type="text" value="[CUG1]"/></p> <p>Coll. Type: <input type="text" value="Standard"/></p> <p>Critical Ping: <input type="text" value="Disable"/></p> <p>Dashboard: <input type="text" value="None"/></p> <p>Event Mask: <input type="text" value="Group in blocks every 10 minutes"/></p> <p style="text-align: center;"><b>Save</b></p> </div> <div> <p>Organization: <input type="text" value="Intel"/></p> <p>Asset:</p> <p><b>Actions</b></p> <ul style="list-style-type: none"> <li>My Bookmarks (Ctrl+Alt+B)</li> <li>Add IP Address</li> <li>Select Primary IP Addresses</li> <li>Clear Device Cache</li> <li>Create a Ticket (Ctrl+Alt+Enter)</li> <li><b>Custom Navigation</b></li> <li>Device Class</li> <li>Device Children</li> <li>Device Groups (Ctrl+Alt+D)</li> <li>Notepad Editor</li> <li>Product Catalog</li> <li>Report Creator</li> <li>Resource Usage (Ctrl+Alt+U)</li> <li>Secondary Credentials</li> <li>Merge Device</li> </ul> <p><input type="checkbox"/> Dynamic Discovery</p> <p><input checked="" type="checkbox"/> Preserve Hostname</p> <p><input type="checkbox"/> Disable Asset Update</p> </div> </div>												

4. The **Custom Navigation** modal page appears.

The screenshot shows a modal window titled "Custom Navigation" with a "Close / Esc" button in the top right corner. The main content area is titled "For Device [35]" and includes a "Refresh" button. Below the title bar, there are three input fields: "Title (Shown on Tab)", "Limit Access" (a dropdown menu currently showing "Administrators"), and "External URL / URI Link". A "Save" button is located below these fields. At the bottom of the modal, there is a table with four columns: "Title (Shown on Tab)", "Access", "User Edit", and "Date Edit".

5. To create a custom tab in the **Device Administration** panel for the device, enter values in the following fields:

- **Title (Shown on Tab)**. Enter a name for the tab. This name will appear on a new tab in the Device Administration tools for this device.
- **Limit Access**. Users who will be allowed to access the custom tab, based on the type of user account. The choices are:
  - *Administrators*. Only users with account type "Administrator" are allowed to access this tab.
  - *Users*. Both users with account type "User" and users with account type "Administrator" are allowed to access this tab.
- **External URL / URI Link**. The URL of the page that is displayed when a user selects the tab. The page can be an internal page in SL1 or an external web page. This field can contain any combination of alphanumeric characters, with a maximum length of 128 characters. Forward slash (/), underscore (\_), and question mark (?) are allowed.

---

## Editing a Custom Navigation tab

After you have defined one or more custom tabs in the **Device Administration** panel, each tab appears as an entry in the **Register** pane in the bottom of the **Custom Navigation** modal page.

To edit a custom tab:

1. Go to the **Device Manager** page (Registry > Devices > Device Manager).
2. In the **Device Manager** page, find the device for which you want to edit a custom tab. Select its wrench icon ().
3. In any page in the **Device Administration** panel, select the **[Actions]** menu and choose **Custom Navigation**.

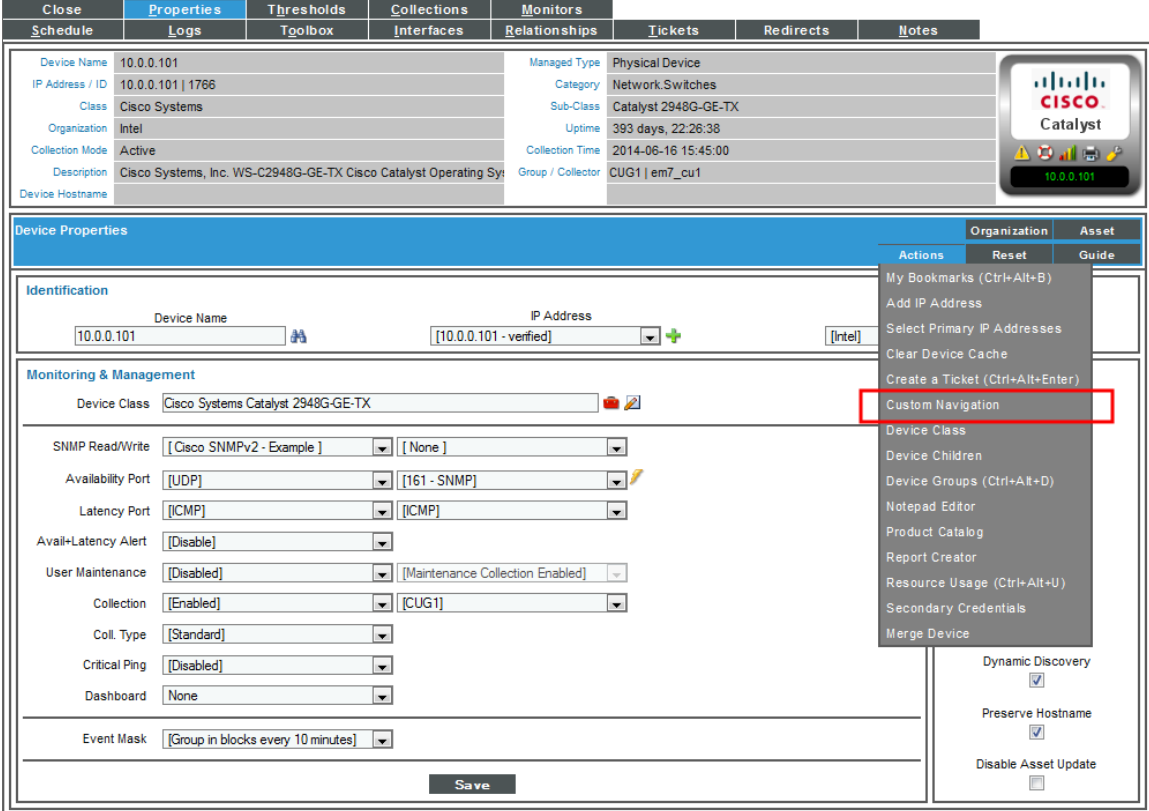



The screenshot displays the Cisco Catalyst Device Administration interface. At the top, there are several tabs: Close, Properties, Thresholds, Collections, Monitors, Schedule, Logs, Toolbox, Interfaces, Relationships, Tickets, Redirects, and Notes. Below these tabs, a table shows device details for IP 10.0.0.101, including its name, class, organization, and uptime. A 'Cisco Catalyst' logo is visible in the top right corner.

The main section is titled 'Device Properties' and is divided into 'Identification' and 'Monitoring & Management' sections. The 'Identification' section includes fields for Device Name (10.0.0.101), IP Address (10.0.0.101 - verified), and Organization (Intel). The 'Monitoring & Management' section contains various configuration options such as Device Class, SNMP Read/Write, Availability Port, Latency Port, User Maintenance, Collection, Coll. Type, Critical Ping, Dashboard, and Event Mask.

An 'Actions' menu is open on the right side of the 'Monitoring & Management' section. The menu items include: My Bookmarks (Ctrl+Alt+B), Add IP Address, Select Primary IP Addresses, Clear Device Cache, Create a Ticket (Ctrl+Alt+Enter), Custom Navigation (highlighted with a red box), Device Class, Device Children, Device Groups (Ctrl+Alt+D), Notepad Editor, Product Catalog, Report Creator, Resource Usage (Ctrl+Alt+U), Secondary Credentials, Merge Device, Dynamic Discovery (checked), Preserve Hostname (checked), and Disable Asset Update (unchecked). A 'Save' button is located at the bottom of the 'Monitoring & Management' section.

4. The **Custom Navigation** modal page appears:

Title (Shown on Tab)	Access	User Edit	Date Edit
1. Navigation Examp	Access	em7admin	2013-07-02 13:58:17

5. Go to the **Register** pane. Find the custom tab you want to edit. Select its wrench icon (  ).
6. The fields in the top pane will be populated with values from the selected custom tab.
7. You can edit the values in one or more fields. Select the **[Save]** button to save your changes to the custom tab.
8. To delete the custom tab, go to the **Register** pane. Find the custom tab you want to edit. Select its bomb icon (  ).

**NOTE:** for details on creating a custom Navigation Tab for all devices, see the manual *Customizing User Experience*.



---

# Chapter

# 15

## Vanishing & Purging Devices

---

### Overview

If SL1 cannot retrieve information about a component device for the amount of time specified in the **Component Vanish Timeout** field (in either the **Global Threshold Settings** page, the **Device Thresholds** page for the component device, or the **Device Thresholds** page for a device higher in the component tree), SL1 sets the device to "vanished". When a device is set to "vanished", SL1 stops trying to collect data about the component device. The vanished device will not appear in reports or views. The vanished device will appear only in the **Vanished Device Manager** page. When a device is set to "vanished", all children of that device are also set to "vanished".



**NOTE:** A vanished device automatically returns to a monitored state when the root device reports the device in the latest inventory of the component device discovery application.

After a device is vanished for the amount of time specified in the **Component Purge Timeout** field (in either the **Global Threshold Settings** page, the **Device Thresholds** page for the component device, or the **Device Thresholds** page for a device higher in the component tree), SL1 purges the device. Purged devices are completely removed from SL1 and all associated data is deleted. When a device is purged, all children of that device are also purged.

The **Vanished Device Manager** page (Devices > Vanished Devices) displays a list of all component devices that have "vanished" from SL1.

**NOTE:** The vanishing and purging functions apply only to component devices and merged physical and component devices. Physical, IP-based devices and virtual devices that have not been merged with a component device are never vanished or purged.

Use the following menu options to navigate the SL1 user interface:

- To view a pop-out list of menu options, click the menu icon (.
- To view a page containing all of the menu options, click the Advanced menu icon (.

This chapter includes the following topics:

<a href="#">Setting Vanish and Purge Thresholds</a>	282
<a href="#">Viewing the List of Vanished Devices</a>	283
<a href="#">Filtering the List of Devices</a>	285
<a href="#">Using the Advanced Filters</a>	286
<a href="#">Unmerging Vanished Devices</a>	288
<a href="#">Manually Purging Selected Devices</a>	289
<a href="#">Setting One or More Devices to Never Purge</a>	290

---

## Setting Vanish and Purge Thresholds

Two threshold settings control the vanishing and purging behavior for component devices:

- **Component Vanish Timeout.** If SL1 cannot retrieve information from a root device about a component device, this threshold specifies how many minutes to wait until putting the component device into "vanish" mode. When a device is set to "vanished", SL1 stops trying to collect data from the component device. The vanished device will not appear in reports or views. The vanished device will appear in the [Vanished Device Manager](#) page. If this threshold is set to zero for a component device, the component device is never set to "vanished".
- **Component Purge Timeout.** This field specifies the number of hours a device can be set to "vanished" before SL1 purges the component device. When a device is purged, SL1 stops trying to collect data from the component device. The purged device will not appear in reports or views in any pages in the user interface. When a device is purged, all of its configuration data and collected data is deleted from SL1. If this threshold is set to zero for a component device, the component device is never purged.

SL1 uses the following logic to determine the threshold value for a given component device when determining whether the component should be vanished or purged:

- If the threshold has been configured in the [Device Thresholds](#) page for the component device, that threshold value is used.
- If the threshold has not been configured in the [Device Thresholds](#) page for the component device, but the threshold has been configured in the [Device Thresholds](#) page for an ancestor of the component device (i.e., a component device in the component tree between the root device and the component device), that threshold value is used. If multiple ancestors have the threshold configured in the [Device Thresholds](#) page, SL1 uses the threshold value for the component device that is closest to the root device (furthest up the tree).

- If the threshold has not been configured in the [Device Thresholds](#) page for the component device or an ancestor of the component device, the threshold value defined in the **Global Threshold Settings** page (System > Settings > Thresholds) is used.

## Viewing the List of Vanished Devices

The **Vanished Device Manager** page (Devices > Vanished Devices) displays the following about each device:

The screenshot shows the 'Vanished Device Manager' interface with a table of 5 vanished devices. The table has columns for Device Name, IP Address, Device Category, Device Class / Sub-class, DID, Organization, Current State, Collection Group, Collection State, Vanished Date, and High Limit. The devices listed are VM1, VM2, VM4, VM5, and VM7.

Device Name	IP Address	Device Category	Device Class / Sub-class	DID	Organization	Current State	Collection Group	Collection State	Vanished Date	High Limit
VM1	--	Virtual Infrastructure Content   VirtualMachine	6	System	Healthy	CUG	Active	2013-10-10 17:55:00	Never Purge	
VM2	--	Virtual Infrastructure Content   VirtualMachine	13	System	Healthy	CUG	Active	2013-10-11 18:56:00	Never Purge	
VM4	--	Virtual Infrastructure Content   VirtualMachine	7	System	Healthy	CUG	Active	2013-10-11 18:56:00	Never Purge	
VM5	--	Virtual Infrastructure Content   VirtualMachine	14	System	Warning	CUG	Active	2013-10-11 17:57:00	Never Purge	
VM7	--	Virtual Infrastructure Content   VirtualMachine	10	System	Warning	CUG	Active	2013-10-11 17:57:00	Never Purge	

**TIP:** To sort the list of devices, click on a column heading. The list will be sorted by the column value, in ascending order. To sort by descending order, click the column heading again.

- **Device Name.** Name of the device. For devices running SNMP or with DNS entries, the named device is discovered automatically. For devices without SNMP or DNS entries, the device's IP address will appear in this field.
- **IP Address.** The IP address of the device.
- **Device Category.** The ScienceLogic category assigned to the device. Categories include servers, routers, switches, firewalls, printers, etc. The category is automatically assigned during discovery, at the same time as the Device Class/Sub-Class.
- **Device Class/Sub-class.** The manufacturer (device class) and type of device (sub-class). The Device Class/Sub-Class is automatically assigned during discovery, at the same time as the as Category.
- **DID.** Device ID. This is a unique number automatically assigned to the device by SL1.
- **Organization.** The organization to which the device is assigned.

- **Current State.** Condition of the device, based upon events generated by the device. Condition can be one of the following:
  - *Critical.* Device has a serious problem that requires immediate attention.
  - *Major.* Device has a problem that requires immediate attention.
  - *Minor.* Device has a less-serious problem.
  - *Notice.* Device has an informational event associated with it.
  - *Healthy.* Device is running with no problems.
  
- **Collection Group.** Specifies the collector group to which the device belongs. Collector Groups are defined in the **Collector Group Management** page (System > Settings > Collector Groups) and specify one or more ScienceLogic Data Collectors. An ScienceLogic Data Collector is the appliance that gathers data from the device. For All-In-One Appliances, this field displays only the built-in Collector Group (and any virtual Collector Groups).
  
- **Collection State.** Collection state can be one of the following:
  - *Active.* SL1 is currently collecting data from the device.
  - *Disabled.* SL1 is not currently collecting data from the device.
  - *Unavailable.* The device is currently unavailable, so SL1 cannot collect data from the device at this time.
  - *Component Vanished.* The component device has vanished. SL1 cannot collect data from the device at this time.
  
- **Vanished Date.** Date on which the device was set to "vanished". If SL1 cannot retrieve information from a root device about component device for the amount of time specified in the **Component Vanish Timeout** field (defined globally in the **Global Threshold Settings** page or for an individual device in the **Device Thresholds** page), SL1 sets the device to "vanished". When device is set to "vanished", SL1 stops trying to collect data from the component device. The vanished device will not appear in reports or views. The vanished device will appear only in the **Vanished Device Manager** page.
  
- **Hours Until Purge.** Based on the threshold **Component Purge Timeout**, specifies the number of hours until the vanished device will be purged. When a device is purged, SL1 stops trying to collect data from the component device. The purged device will not appear in reports or views in any pages in the user interface. When a device is purged, all of its configuration data and collected data is deleted from the Database Server. You can define a global threshold for **Component Purge Timeout** in the **Global Threshold Settings** page. You can override the global threshold and define the **Component Purge Timeout** threshold for a single device in the device **Device Thresholds** page.

**NOTE:** To ensure that one or more devices are never purged, [you can set one or more devices to never purge.](#)

**NOTE:** To manually purge a device prior to the **Hours to Purge** time, [you can manually purge selected devices.](#)

**NOTE:** When a device is set to "vanished", all children of that device are also set to "vanished". When a device is purged, all children of that device are also purged.

## Filtering the List of Devices

You can filter the list on the **Custom Attribute Manager** page by one or more parameters. Only devices that meet all the filter criteria will be displayed in the **Custom Attribute Manager** page.

To filter by parameter, enter text into the desired filter-while-you-type field. The **Web Content Monitoring** page searches for devices that match the text, including partial matches. By default, the cursor is placed in the left-most filter-while-you-type field. You can use the <Tab> key or your mouse to move your cursor through the fields. The list is dynamically updated as you type. Text matches are not case-sensitive.

You can also use *special characters* to filter each parameter.

Filter by one or more of the following parameters:

- **Device Name.** You can enter text to match, including special characters, and the **Vanished Device Manager** page will display only devices that have a matching device name.
- **IP Address.** You can enter text to match, including special characters, and the **Vanished Device Manager** page will display only devices that have a matching IP address.
- **Device Category.** You can enter text to match, including special characters, and the **Vanished Device Manager** page will display only devices that have a matching device category.
- **Device Class.** You can enter text to match, including special characters, and the **Vanished Device Manager** page will display only devices that have a matching device class.
- **DID.** You can enter text to match, including special characters, and the **Vanished Device Manager** page will display only devices that have a matching device ID.
- **Organization.** You can enter text to match, including special characters, and the **Vanished Device Manager** page will display only devices that have a matching organization.
- **Current State.** Specifies the device's current state. Only those devices that match all the previously selected fields and have the specified condition will be displayed. A device's condition is determined by its most severe, outstanding event. The choices are:
  - **>=Healthy.** Include devices with a condition of "Healthy" or greater. This will include all devices.
  - **>=Notice.** Include devices with a condition of "Notice" or greater. This means, include devices with a condition of "Notice", "Minor", "Major", and "Critical".
  - **>=Minor.** Include devices with a condition of "Minor" or greater. This means, include devices with a condition of "Minor", "Major", and "Critical".
  - **>=Major.** Include devices with a condition of "Major" or greater. This means, include devices with a condition of "Major" and "Critical".

- *>=Critical*. Include devices with a condition of "Critical" or greater. This means, include devices with a condition of "Critical", because there is no "greater" condition.
- **Collection Group**. You can enter text to match, including special characters, and the **Vanished Device Manager** page will display only devices that have a matching Collector Group.
- **Collection State**. You can enter text to match, including special characters, and the **Vanished Device Manager** page will display only devices that have a matching Collection State.
- **Vanished Date**. Date on which the device vanished. The **Vanished Device Manager** page will display only devices that match the specified vanish date. The choices are:
  - *All*. Display all tickets that match the other filters.
  - *Last Minute*. Display only tickets that have been created within the last minute.
  - *Last Hour*. Display only tickets that have been created within the last hour.
  - *Last Day*. Display only tickets that have been created within the last day.
  - *Last Week*. Display only tickets that have been created within the last week.
  - *Last Month*. Display only tickets that have been created within the last month.
  - *Last Year*. Display only tickets that have been created within the last year.
- **Hours Until Purge**. You can enter text to match, including special characters, and the **Vanished Device Manager** page will display only devices that have a matching number of hours until the device is purged.

---

## Using the Advanced Filters

In the **Vanished Device Manager** page, you can specify one or more parameters to filter the display of devices. Only devices that meet all the filter criteria will be displayed.

The Advanced Filter Tool allows you to make selections instead of manually typing in a string to filter on.

**TIP:** To select multiple entries in the Advanced Filter Tool, hold down the **<Ctrl>** key and left-click the entries.

- After selecting all filters, select the **[Apply]** button to apply the filters to the list of devices.
- To reset each field and apply no filters, select the **[Reset]** button.

To access the Advanced Filter Tool:

1. Go to the **Vanished Device Manager** page.
2. Click on the funnel icon (  ).
3. The Advanced Filter Tool will display advanced filters for each column in the page.

**NOTE:** Unlike the "find while you type" feature, the Advanced Filter Tool is not applied to the list of devices until you select the **[Apply]** button.

4. In the Advanced Filter Tool, you can filter by one or more of the following filters:
  - **Device Name.** In the **Match Any** fields, you can enter one or more text strings to match, including special characters. The **Vanished Device Manager** page will display only devices that have a matching device name.
  - **IP Address.** In the **Match Any** fields, you can enter one or more text strings to match, including special characters. The **Vanished Device Manager** page will display only devices that have a matching IP address.
  - **Device Category.** Select from a list of device categories that have member devices. The **Vanished Device Manager** page will display only devices that have a matching device category. In the **Match Any** fields, you can enter one or more text strings to match, including special characters.
  - **Device Class | Sub-class.** In the **Match Any** fields, you can enter one or more text strings to match, including special characters. The **Vanished Device Manager** page will display only devices that have a matching device class or sub-class.
  - **DID.** In the **From** and **To** field, you can specify a range of device IDs. The **Vanished Device Manager** page will display only devices that fall within that range of device IDs.
  - **Organization.** Select from a list of organizations that have member devices. The **Vanished Device Manager** page will display only devices that have a matching organization. In the **Match Any** fields, you can enter one or more text strings to match, including special characters.
  - **Current State.** You can select from a list of device states. The **Vanished Device Manager** page will display only devices that have a matching state.
  - **Collection Group.** Select from a list of collection groups that have member devices. The **Vanished Device Manager** page will display only devices that have a matching collection group.
  - **Collection State.** You can select from a list of collection states. The **Vanished Device Manager** page will display only devices that have a matching state.
  - **Vanished Date.** In the **From** and **To** field, you can specify a range of vanished dates, in the format yyyy-mm-dd hh:mm:ss. The **Vanished Device Manager** page will display only device with a vanished date that falls within that range of date.
  - **Hours Until Purge.** In the **Match Any** fields, you can enter one or more text strings to match, including special characters. The **Vanished Device Manager** page will display only devices that have a matching number of hours until purge.
5. After selecting all filters, select the **[Apply]** button to apply the filters to the list of devices.
6. To reset each field and apply no filters, select the **[Reset]** button.

**TIP:** You can perform an advanced filter and then perform a second advanced filter on the results of the first advanced filter. You can continue to modify and apply an advanced filter multiple times.

## Unmerging Vanished Devices

To unmerge a vanished device:

1. Go to the **Vanished Device Manager** page (Registry > Devices > Vanished Device Manager).

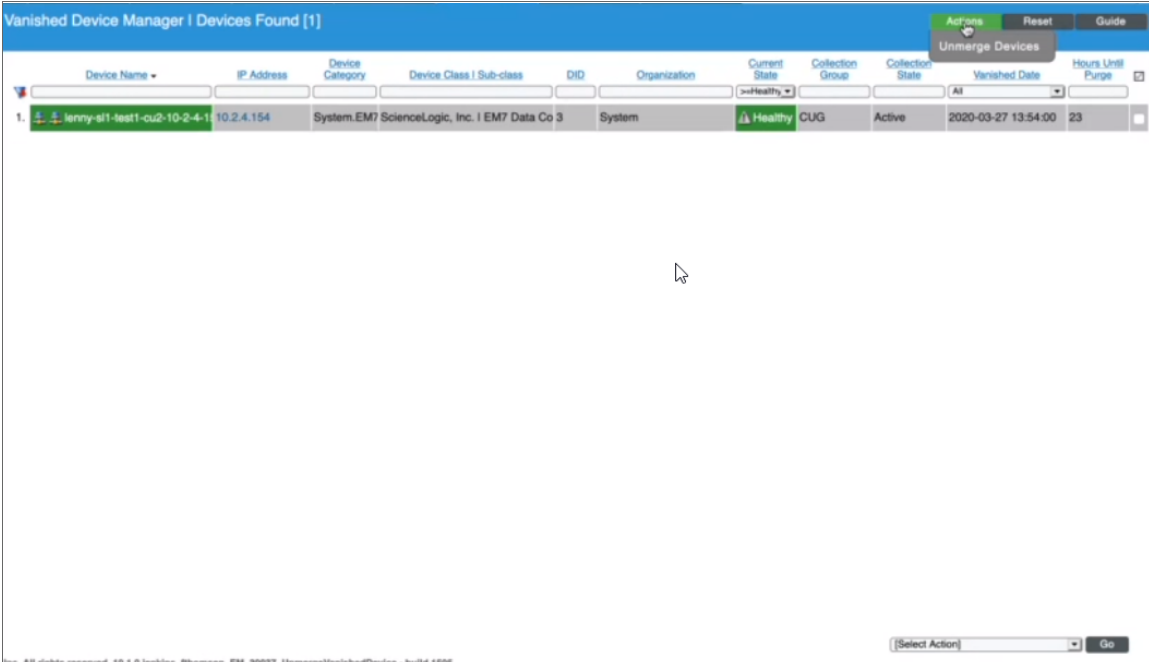

The screenshot shows the 'Vanished Device Manager' interface. At the top, there are buttons for 'Actions', 'Reset', and 'Guide'. The 'Actions' menu is open, showing 'Unmerge Devices' as the selected option. Below the menu is a table with the following columns: Device Name, IP Address, Device Category, Device Class | Sub-class, DID, Organization, Current State, Collection Group, Collection State, Vanished Date, and Hours Until Purge. A single device is listed in the table with the following details:

Device Name	IP Address	Device Category	Device Class   Sub-class	DID	Organization	Current State	Collection Group	Collection State	Vanished Date	Hours Until Purge
jenry-el1-test1-cu2-10-2-4-1	10.2.4.154	System.EM7	ScienceLogic, Inc.   EM7 Data Co 3		System	Healthy	CUG	Active	2020-03-27 13:54:00	23

At the bottom of the interface, there is a '(Select Action)' dropdown menu and a 'Go' button. The footer text reads: 'Inc. All rights reserved. 10.1.0.jenkins.rhomasan.EM\_30037 UnmergeVanishedDevice - build 1505'.

2. Select the **[Actions]** menu and then choose **Unmerge Devices**.



Device Bulk Unmerge Vanished   Devices Found (1)												
Device Name	IP Address	Device Category	Device Class / Sub-class	DID	Organization	Device Name	IP Address	Device Class / Sub-class	DID	Organization	Merged By	Merged Date
1.	<input checked="" type="checkbox"/>	10.2.1.10	System ScienceLogic, Inc. 3	System		level2_e		2level-dcm-2   level 11	backand	em7admin	2020-03-27 1	<input type="checkbox"/>

3. The **Device Bulk Unmerge Vanished** page displays a list of merged devices. Each numbered row indicates a pair of merged devices that can be unmerged. Select the checkboxes in the last column of each row of devices that you want to unmerge, then select the **[Unmerge]** button.
4. A modal window displays that asks you to confirm the unmerging. Select the **[Unmerge]** button.
5. When the message, "Device Bulk Unmerge complete" displays, select the **[Close/Esc]** button.
6. The physical device will once again appear in the **Device Manager** page (Registry > Devices > Device Manager).

## Manually Purging Selected Devices

You can manually purge one or more devices in the **Vanished Device Manager** page.

When a device is purged, SL1 stops trying to collect data from the component device. The purged device will not appear in reports or views in any pages in the user interface. When a device is purged, all of its configuration data and collected data is deleted from the Database Server.

**NOTE:** When a device is purged, all children of that device are also purged.

To purge one or more vanished devices:

1. In the **Vanished Device Manager** page (Devices > Vanished Devices), select the checkbox for each device you want to purge. To select all checkboxes for all devices, select the red checkbox (☒) at the top of the page.

The screenshot shows the 'Vanished Device Manager' interface with a table of devices. The table has columns for Device Name, IP Address, Device Category, Device Class | Sub-class, GUID, Organization, Current State, Collection Group, Collection State, Vanished Date, and High Load Purge. Five devices are listed, with VM1 highlighted. A context menu is open over the 'Never Purge' column for VM1, showing options: 'Set Selected Devices To Never Purge' and 'Purge Selected Devices'. The 'Go' button is also visible.

Device Name	IP Address	Device Category	Device Class   Sub-class	GUID	Organization	Current State	Collection Group	Collection State	Vanished Date	High Load Purge	
VM1	--	Virtual Infrastructu	Content   VirtualMachine	8	System	Healthy	CUG	Active	2013-10-10 17:55:00	Never Purge	
VM2	--	Virtual Infrastructu	Content   VirtualMachine	13	System	Healthy	CUG	Active	2013-10-11 18:56:00	Never Purge	
VM4	--	Virtual Infrastructu	Content   VirtualMachine	7	System	Healthy	CUG	Active	2013-10-11 18:56:00	Never Purge	
VM5	--	Virtual Infrastructu	Content   VirtualMachine	14	System	Warning	--	CUG	Active	2013-10-11 17:57:00	Never Purge
VM7	--	Virtual Infrastructu	Content   VirtualMachine	10	System	Warning	--	CUG	Active	2013-10-11 17:57:00	Never Purge

2. In the **Select Action** drop-down list, select *Purge Selected Devices*.
3. Select the **[Go]** button.

## Setting One or More Devices to Never Purge

You can specify that a vanished device should never be purged. When you define this setting for a device, the device is never purged, regardless of the global threshold for **Component Purge Timeout** in the **Global Threshold Settings** page or the **Component Purge Timeout** threshold set for the device in the **Device Thresholds** page.

To set one or more vanished devices to never be purged:

1. In the **Vanished Device Manager** page (Devices > Vanished Devices), select the checkbox for each device you want to prevent from being purged. To select all checkboxes for all devices, select the select the red checkbox (☒) at the top of the page.

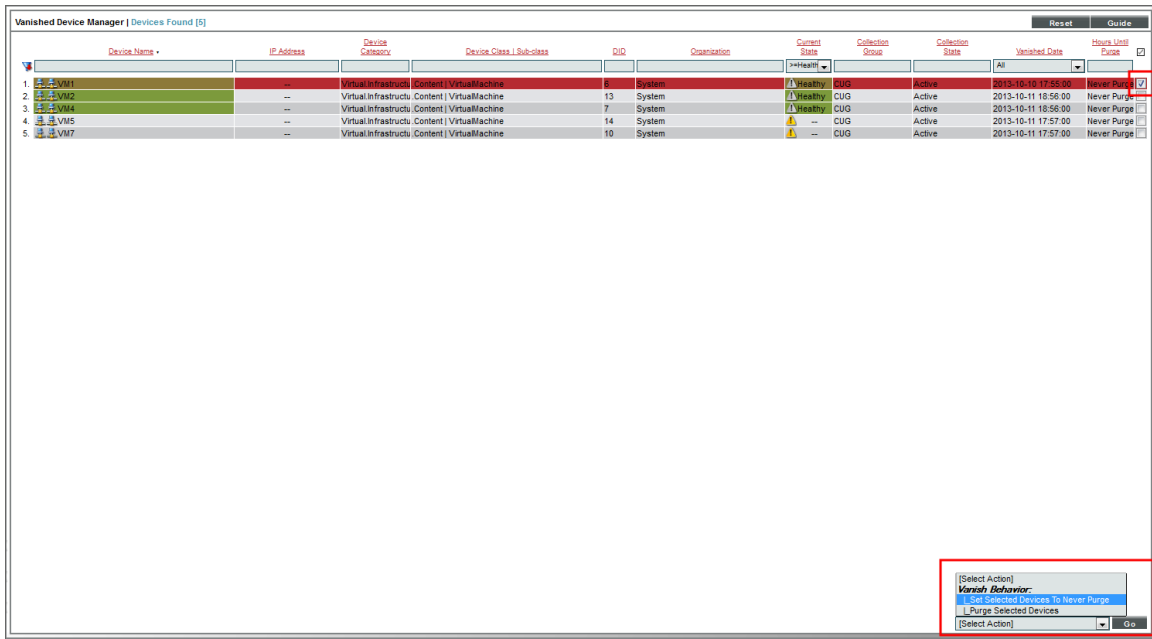

2. In the **Select Action** drop-down list, select *Set Selected Devices to Never Purge*.
3. Select the **[Go]** button.

---

# Chapter

# 16

## Device Dashboards

---

### Overview

A dashboard is a page that displays graphical reports. Each report, called a widget, is displayed in its own pane. To define a graphical report, you select from a list of pre-defined widgets and then customize the selected widget by supplying values in the configuration fields. The customized widget then generates a graph, chart, table, or other information in a pane in the dashboard. For information on generating and viewing dashboards, see the **Dashboards** manual.

The **Device Summary** page, which appears when you select the graph icon () for a device in the classic user interface for SL1, displays one or more dashboards similar to the dashboards available under the **[Dashboards]** tab.

Dashboards for the **Device Summary** page are always displayed with the context set to the device being viewed. Typically, the widgets on a device dashboard are configured to read the device context. As a result, the widgets display data for the device being viewed.



The **Device Dashboards** page (System > Customize > Device Dashboards) displays a list of dashboards that can be displayed for a device in the **Device Summary** page. From the **Device Dashboards** page, you can create, edit, delete, and align device dashboards.

This chapter includes the following topics:

<i>Viewing the List of Device Dashboards</i> .....	293
<i>Creating a Device Dashboard</i> .....	295
<i>Aligning Device Dashboards</i> .....	296
<i>Aligning a Device Dashboard with a Device</i> .....	296
<i>Aligning a Device Dashboard with a Device Class</i> .....	297
<i>Aligning a Device Dashboard with a Device Category</i> .....	298

<i>Aligning a Device Dashboard with a Dynamic Application</i> .....	299
<b>Editing a Device Dashboard</b> .....	300
<b>Deleting a Device Dashboard</b> .....	300
<b>Copying a Device Dashboard</b> .....	301
<b>Defining the Global Default for Device Dashboards</b> .....	301
<b>Unaligning a Device Dashboard</b> .....	303
<b>Moving Alignment for Device Dashboards</b> .....	304

Use the following menu options to navigate the SL1 user interface:

- To view a pop-out list of menu options, click the menu icon ()
- To view a page containing all of the menu options, click the Advanced menu icon ()

This chapter includes the following topics:

<b>Viewing the List of Device Dashboards</b> .....	293
<b>Creating a Device Dashboard</b> .....	295
<b>Aligning Device Dashboards</b> .....	296
<i>Aligning a Device Dashboard with a Device</i> .....	296
<i>Aligning a Device Dashboard with a Device Class</i> .....	297
<i>Aligning a Device Dashboard with a Device Category</i> .....	298
<i>Aligning a Device Dashboard with a Dynamic Application</i> .....	299
<b>Editing a Device Dashboard</b> .....	300
<b>Deleting a Device Dashboard</b> .....	300
<b>Copying a Device Dashboard</b> .....	301
<b>Defining the Global Default for Device Dashboards</b> .....	301
<b>Unaligning a Device Dashboard</b> .....	303
<b>Moving Alignment for Device Dashboards</b> .....	304

---

## Viewing the List of Device Dashboards

The **Device Dashboards** page displays a list of existing device dashboards. These dashboards include predefined device dashboards (which are installed with SL1 or can be installed with a PowerPack) and any user-defined device dashboards.

For each device dashboard, the **Device Dashboards** page displays:

Device Dashboard Name	ID	Global Default	Categories	Classes	Devices	Dynamic Apps	Edited By	Last Edited
1. AWS Account	90	No	0	1	0	1	em7admin	2017-04-13 08:42:33
2. AWS Auto Scale Group	95	No	0	1	0	1	em7admin	2017-04-13 08:42:36
3. AWS EBS Instance	92	No	0	1	0	1	em7admin	2017-04-13 08:42:34
4. AWS EC2 Instance	91	No	0	11	0	1	em7admin	2017-04-13 08:42:34
5. AWS ELB Instance	95	No	0	1	0	1	em7admin	2017-04-13 08:42:36
6. AWS OpsWorks Stack	98	No	0	1	0	1	em7admin	2017-04-13 08:42:38
7. AWS RDS Instance	89	No	0	2	0	1	em7admin	2017-04-13 08:42:33
8. AWS Redshift Cluster	93	No	0	1	0	1	em7admin	2017-04-13 08:42:35
9. AWS Redshift Node	94	No	0	1	0	1	em7admin	2017-04-05 10:41:24
10. AWS SNS Topic	88	No	0	1	0	1	em7admin	2017-04-13 08:42:33
11. AWS SQS Instance	97	No	0	1	0	1	em7admin	2017-04-13 08:42:36
12. Cisco TelePresence Conductor	125	No	0	1	0	0	em7admin	2017-04-10 01:30:57
13. Cisco TelePresence MCU	125	No	0	1	0	0	em7admin	2017-04-10 01:30:57
14. Cisco TelePresence Server	127	No	0	1	0	0	em7admin	2017-04-10 01:30:57
15. Cisco ACI APIC	72	No	0	1	0	0	em7admin	2017-04-05 10:06:15
16. Cisco ACI Application	75	No	0	1	0	0	em7admin	2017-04-05 10:06:21
17. Cisco ACI Endpoint Group	76	No	0	1	0	0	em7admin	2017-04-05 10:06:21
18. Cisco ACI Leaf Switch	73	No	1	0	0	0	em7admin	2017-04-05 10:06:16
19. Cisco ACI Pod	71	No	0	1	0	0	em7admin	2017-04-05 10:06:15
20. Cisco ACI Root	77	No	0	1	0	0	em7admin	2017-04-05 10:06:25
21. Cisco ACI Spine Switch	74	No	1	0	0	0	em7admin	2017-04-05 10:06:20
22. Cisco ACI Tenant	78	No	0	1	0	0	em7admin	2017-04-05 10:06:25
23. Cisco CCE Admin and Data Server	109	No	0	1	0	0	em7admin	2017-04-05 19:05:03
24. Cisco CCE Call Router	107	No	0	1	0	0	em7admin	2017-04-05 19:05:00
25. Cisco CCE Campaign	113	No	0	1	0	0	em7admin	2017-04-05 19:05:05

**TIP:** To sort the list of dashboards, click on a column heading. The list will be sorted by the column value, in ascending order. To sort by descending order, click the column heading again. The **Last Edited** column sorts by descending order on the first click; to sort by ascending order, click the column heading again.

- **Device Dashboard Name.** Name of the device dashboard.
- **ID.** Unique ID that SL1 automatically assigned to each device dashboard.
- **Global Default.** Specifies whether the device dashboard is the default device dashboard for all devices.
- **Categories.** Specifies the number of device categories aligned with the device dashboard.
- **Classes.** Specifies the number of device classes aligned with the device dashboard.
- **Devices.** Specifies the number of devices that have been manually aligned with the device dashboard.
- **Dynamic Apps.** Specifies the number of Dynamic Applications that are aligned with the device dashboard.
- **Edited By.** ScienceLogic user who created or last edited the device dashboard.
- **Last Edited.** Date and time the device dashboard was created or last edited.

**NOTE:** By default, the cursor is placed in the first Filter-While-You-Type field. You can use the <Tab> key or your mouse to move your cursor through the fields.

---

## Creating a Device Dashboard

To create a device dashboard:

1. Go to the **Device Dashboards** page (System > Customize > Device Dashboards).
2. In the **Device Dashboards** page, click the **[Create]** button.
3. The **Device Dashboard Editor** page appears. Supply values in the following fields:

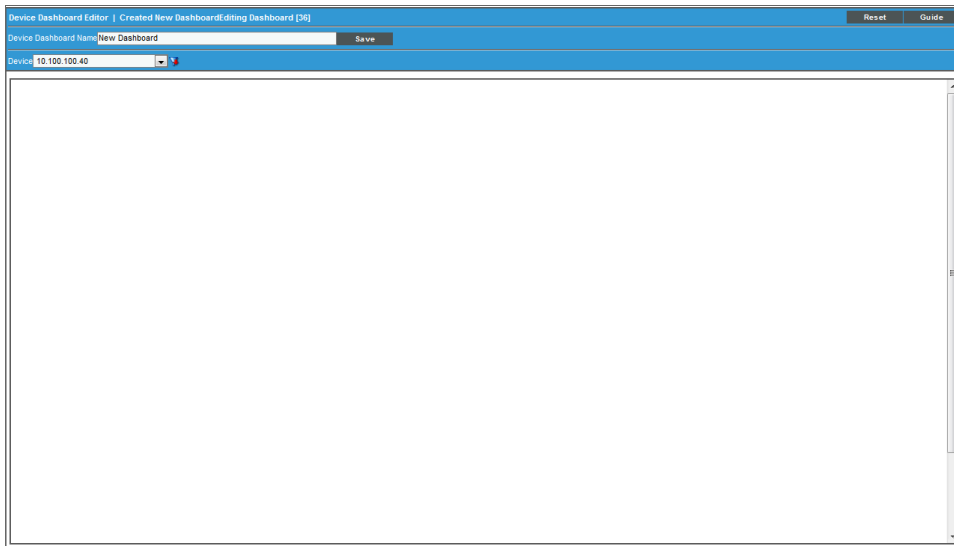

- **Device Dashboard Name.** Name of the device dashboard.
- **Device.** Select a device to provide sample data while you create the dashboard. This device will not be permanently associated with the dashboard.
- **Adding Widgets.** To add a widget, go to the big pane below the **Device** field. Left-click and drag with your mouse to draw a rectangle. This shape will determine the initial size and position of the widget in your dashboard. When the **Widget Configuration** page appears, configure the widget as you would for a dashboard.

**NOTE:** For maximum flexibility, when configuring a device-specific widget, ScienceLogic recommends that you select *Contextual Device (Auto)* in the **Element** field.

**NOTE:** For details on configuring widgets, see the manual *Dashboards*.

4. The new device dashboard is automatically saved.

---

## Aligning Device Dashboards

The device dashboard that is defined as the "Global Default" is the default dashboard that appears in the in the **Device Summary** page for each device.

SL1 decides what to display in the **Device Summary** page as follows:

- If the device is manually aligned with a device dashboard (in the **Device Properties** page), that dashboard is displayed in the **Device Summary** page for the device.
- If the device is not manually aligned with a device dashboard, the device dashboard that is aligned with the Device Class is displayed.
- If the device class is not aligned with a device dashboard, the device dashboard that is aligned with the Device Category is displayed.
- If the device category is not aligned with a device dashboard, the device dashboard that is defined as the "Global Default" is displayed.

**NOTE:** If the *Prefer Global Device Summary Dashboard Over Category/Class* checkbox is checked in the **Behavior Settings** page (System > Settings > Behavior) and a device is not manually aligned with a device dashboard, the dashboard that is defined as the "Global Default" is displayed.

**NOTE:** Although you can align a device dashboard with a Dynamic Application, the device dashboards that are aligned with Dynamic Applications are never displayed in the **Device Summary** page as the default display. However, from the **Device Summary** page, a user can select and view any device dashboards that are aligned with Dynamic Applications for the device.

## Aligning a Device Dashboard with a Device

You can manually align a device dashboard with a device. The device dashboard will then appear as the default view in the **Device Summary** page.

**NOTE:** From the **Device Summary** page, the user can select and view any device dashboards that are associated with the device, the device's device class, the device's device category, the device's Dynamic Applications, and the Global Default.

To align a device dashboard with a device:

1. Go to the **Device Manager** page (Registry > Devices > Device Manager).
2. Find the device you want to align with a device dashboard. Click the wrench icon () for that device.



3. In the **Device Properties** page, edit the following field:

Close	Properties	Thresholds	Collections	Monitors	Schedule	Logs
Togbox	Interfaces	Relationships	Tickets	Redirects	Notes	Attributes

Device Name	em7_ao	Managed Type	Physical Device
IP Address / ID	10.64.68.17   677	Category	System:EM7
Class	ScienceLogic, Inc.	Sub-Class	OEM
Organization	System	Uptime	6 days, 00:08:53
Collection Mode	Active	Collection Time	2015-11-05 12:40:00
Description	ScienceLogic EM7 G3 - All-in-One	Group / Collector	CUG   em7_ao
Root Device	CUCM10-01.qa.sciencelogic.local	Parent Device	Services
Device Hostname			

Device Properties		Organization	Asset
		Actions	Reset
			Guide

Identification					
Device Name	em7_ao	IP Address	[10.64.68.17 - verified]	Organization	[System]

Monitoring & Management		Preferences	
Device Class	ScienceLogic, Inc. OEM	Auto-Clear Events	<input checked="" type="checkbox"/>
SNMP Read/Write	[EM7 Default V2] [None]	Accept All Logs	<input checked="" type="checkbox"/>
Availability Port	[UDPI] [161 - SNMP]	Daily Port Scans	<input checked="" type="checkbox"/>
Latency Port	[ICMP] [ICMP]	Auto-Update	<input checked="" type="checkbox"/>
Avail+Latency Alert	[Disable]	Scan All IP's	<input type="checkbox"/>
User Maintenance	[Disable] [Maintenance Collection Enabled]	Dynamic Discovery	<input checked="" type="checkbox"/>
Collection	[Enabled] [CUG]	Preserve Hostname	<input checked="" type="checkbox"/>
Coll. Type	[Standard]	Disable Asset Update	<input type="checkbox"/>
Critical Ping	[Disable]	Bypass Interface Inventory	<input type="checkbox"/>
Dashboard	None		
Event Mask	[Group in blocks every 10 minutes]		

Save

- **Dashboard.** Select a device dashboard from a list of all device dashboards in SL1. The selected device dashboard will appear by default in the **Device Summary** page for this device.

4. Click the **[Save]** button.

## Aligning a Device Dashboard with a Device Class

You can manually align a device dashboard with a device class. For devices that do not have a device dashboard defined in the **Device Properties** page, the device dashboard associated with the Device Class will appear as the default view in the **Device Summary** page.

**NOTE:** From the **Device Summary** page, the user can select and view any device dashboards that are associated with the device, the device's device class, the device's device category, the device's Dynamic Applications, and the Global Default.

To align a device dashboard with a device class:

1. Go to the **Device Class Editor** page (System > Customize > Device Classes).
2. In the **Device Class Register** pane, find the device class you want to align with a device dashboard. Click the wrench icon (  ) for that device class.

- In the **Device Class Editor** page, edit the following field:
  - Dashboard.** Select a device dashboard from a list of all device dashboards in SL1. The selected device dashboard will be associated with all devices that use this device class and will appear as an option in the **Device Summary** page.

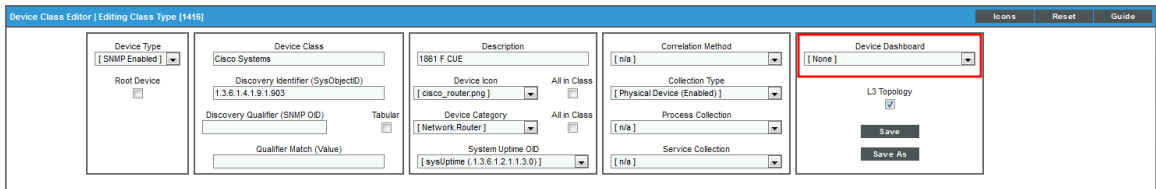

- Click the **[Save]** button.

**NOTE:** If a PowerPack updates one or more device classes, SL1 will not overwrite the alignment between device dashboards and any updated device classes.

## Aligning a Device Dashboard with a Device Category

You can manually align a device dashboard with a device category. For devices that do not have a device dashboard defined in the **Device Properties** page or a device dashboard defined in the **Device Class Editor** page, the device dashboard associated with the Device Category will appear as the default view in the **Device Summary** page.

**NOTE:** From the **Device Summary** page, the user can select and view any device dashboards that are associated with the device, the device's device class, the device's device category, the device's Dynamic Applications, and the Global Default.

To align a device dashboard with a device category:

- Go to the **Device Category Editor** page (System > Customize > Device Categories).
- In the **Register** pane, find the device category you want to align with a device dashboard. Click the wrench icon (🔧) for that device category.
- In the **Editor** pane, edit the following field:
  - Device Dashboard.** Select a device dashboard from a list of all device dashboards in SL1. The selected device dashboard will be associated with all devices that use this device category and will appear as an option in the **Device Summary** page.

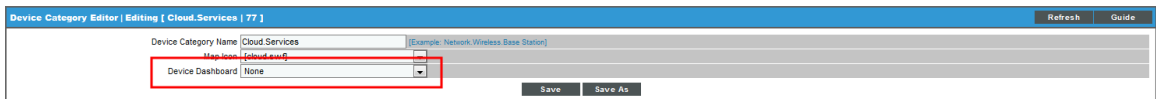

4. Click the **[Save]** button.

**NOTE:** If a PowerPack updates one or more device categories, SL1 will not overwrite the alignment between device dashboards and any updated device categories.

## Aligning a Device Dashboard with a Dynamic Application

You can manually align a device dashboard with a Dynamic Application. For each device that subscribes to the Dynamic Application, the aligned device dashboard will appear as an option in the **Device Summary** page.

**NOTE:** From the **Device Summary** page, the user can select and view any device dashboards that are associated with the device, the device's device class, the device's device category, the device's Dynamic Applications, and the Global Default.

To manually align a device dashboard with a Dynamic Application:

1. Go to the **Dynamic Applications Manager** page (System > Manage > Applications).
2. Find the Dynamic Application you want to align with a device dashboard. Click the wrench icon () for that Dynamic Application.
3. In the **Dynamic Applications Properties Editor** page, edit the following field:
  - **Device Dashboard.** Select a device dashboard from a list of all device dashboards in SL1. The selected device dashboard will be associated with all devices that subscribe to this Dynamic Application and will appear as an option in the **Device Summary** page.

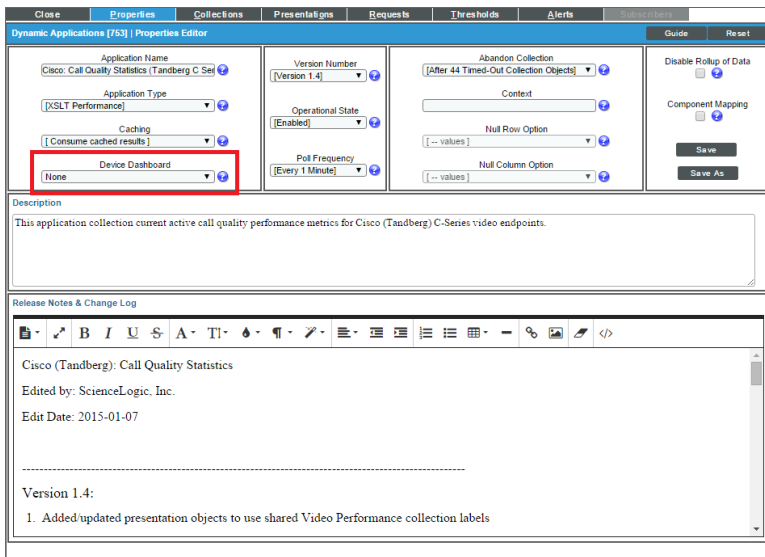

The screenshot shows the 'Dynamic Applications Properties Editor' for 'Cisco: Call Quality Statistics (Tandberg C-Series)'. The 'Device Dashboard' field is highlighted with a red box and is currently set to 'None'. Other fields include 'Application Name', 'Version Number', 'Operational State', 'Poll Frequency', 'Abandon Collection', 'Context', 'Null Row Option', 'Null Column Option', 'Caching', and 'Component Mapping'. The 'Description' field contains the text: 'This application collection current active call quality performance metrics for Cisco (Tandberg) C-Series video endpoints.' The 'Release Notes & Change Log' section shows a list of changes for 'Version 1.4'.

4. Click the **[Save]** button.

**NOTE:** If a PowerPack updates one or more Dynamic Applications, SL1 will not overwrite the alignment between device dashboards and any updated Dynamic Applications.

## Editing a Device Dashboard

To edit a device dashboard:

1. Go to the **Device Dashboards** page (System > Customize > Device Dashboards).
2. In the **Device Dashboards** page, find the device dashboard you want to edit. Click its wrench icon (  ).
3. The **Device Dashboard Editor** page appears. Edit one or more fields and/or the dashboard widgets.
4. SL1 automatically saves your changes.

## Deleting a Device Dashboard

To delete one or more device dashboards:

1. Go to the **Device Dashboards** page (System > Customize > Device Dashboards).
2. In the **Device Dashboards** page, select the checkbox for each dashboard you want to delete.
3. In the **Select Action** drop-down list, select *Delete Dashboards*.

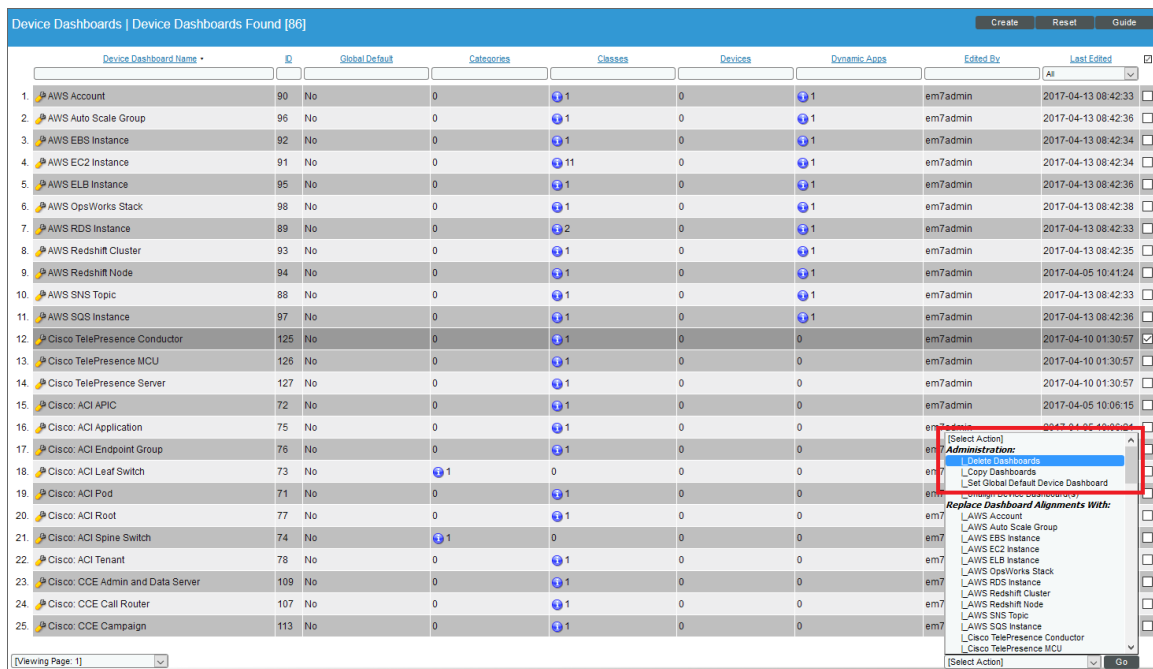

The screenshot shows a table titled "Device Dashboards | Device Dashboards Found [86]". The table has columns for ID, Global Default, Categories, Classes, Devices, Dynamic Apps, Edited By, and Last Edited. A red box highlights the "Select Action" dropdown menu for the dashboard "Cisco: CCE Campaign" (ID 113). The menu options include: Administration, Copy Dashboards, Set Global Default Device Dashboard, Replace Dashboard Alignments With, and a list of dashboard names.

ID	Global Default	Categories	Classes	Devices	Dynamic Apps	Edited By	Last Edited
1. AWS Account	90	No	0	1	0	1	em7admin 2017-04-13 08:42:33
2. AWS Auto Scale Group	96	No	0	1	0	1	em7admin 2017-04-13 08:42:36
3. AWS EBS Instance	92	No	0	1	0	1	em7admin 2017-04-13 08:42:34
4. AWS EC2 Instance	91	No	0	11	0	1	em7admin 2017-04-13 08:42:34
5. AWS ELB Instance	95	No	0	1	0	1	em7admin 2017-04-13 08:42:38
6. AWS OpsWorks Stack	98	No	0	1	0	1	em7admin 2017-04-13 08:42:38
7. AWS RDS Instance	89	No	0	2	0	1	em7admin 2017-04-13 08:42:33
8. AWS Redshift Cluster	93	No	0	1	0	1	em7admin 2017-04-13 08:42:35
9. AWS Redshift Node	94	No	0	1	0	1	em7admin 2017-04-05 10:41:24
10. AWS SNS Topic	88	No	0	1	0	1	em7admin 2017-04-13 08:42:33
11. AWS SQS Instance	97	No	0	1	0	1	em7admin 2017-04-13 08:42:38
12. Cisco TelePresence Conductor	125	No	0	1	0	0	em7admin 2017-04-10 01:30:57
13. Cisco TelePresence MCU	126	No	0	1	0	0	em7admin 2017-04-10 01:30:57
14. Cisco TelePresence Server	127	No	0	1	0	0	em7admin 2017-04-10 01:30:57
15. Cisco: ACI APIC	72	No	0	1	0	0	em7admin 2017-04-05 10:06:15
16. Cisco: ACI Application	75	No	0	1	0	0	em7admin 2017-04-05 10:06:04
17. Cisco: ACI Endpoint Group	76	No	0	1	0	0	em7admin 2017-04-05 10:06:04
18. Cisco: ACI Leaf Switch	73	No	1	0	0	0	em7admin 2017-04-05 10:06:04
19. Cisco: ACI Pod	71	No	0	1	0	0	em7admin 2017-04-05 10:06:04
20. Cisco: ACI Root	77	No	0	1	0	0	em7admin 2017-04-05 10:06:04
21. Cisco: ACI Spine Switch	74	No	1	0	0	0	em7admin 2017-04-05 10:06:04
22. Cisco: ACI Tenant	78	No	0	1	0	0	em7admin 2017-04-05 10:06:04
23. Cisco: CCE Admin and Data Server	109	No	0	1	0	0	em7admin 2017-04-05 10:06:04
24. Cisco: CCE Call Router	107	No	0	1	0	0	em7admin 2017-04-05 10:06:04
25. Cisco: CCE Campaign	113	No	0	1	0	0	em7admin 2017-04-05 10:06:04

- Click the **[Go]** button. The selected device dashboard(s) will no longer appear in this page or be accessible in the **Device Summary** page.

**NOTE:** You cannot delete a device dashboard that is defined as the Global Default.

## Copying a Device Dashboard

To copy one or more device dashboards:

- Go to the **Device Dashboards** page (System > Customize > Device Dashboards).
- In the **Device Dashboards** page, select the checkbox for each dashboard you want to copy.
- In the **Select Action** drop-down list, select **Copy Dashboards**.

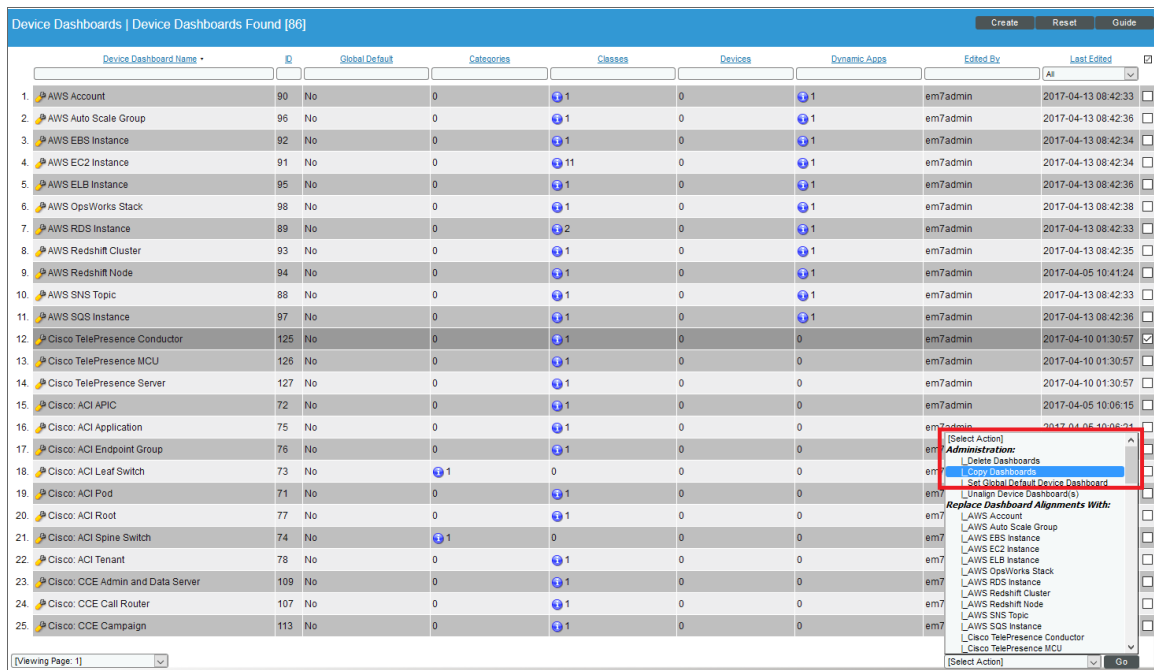

- Click the **[Go]** button. One or more new device dashboards will appear in this page with names that start with "Copy of".

## Defining the Global Default for Device Dashboards

The device dashboard that is defined as the "Global Default" is the default dashboard that appears in the in the **Device Summary** page for each device.

SL1 decides what to display in the **Device Summary** page as follows:

- If the device is manually aligned with a device dashboard (in the **Device Properties** page), that dashboard is displayed in the **Device Summary** page for the device.
- If the device is not manually aligned with a device dashboard, the device dashboard that is aligned with the Device Class is displayed.
- If the device class is not aligned with a device dashboard, the device dashboard that is aligned with the Device Category is displayed.
- If the device category is not aligned with a device dashboard, the device dashboard that is defined as the "Global Default" is displayed.

**NOTE:** If the *Prefer Global Device Summary Dashboard Over Category/Class* checkbox is checked in the **Behavior Settings** page (System > Settings > Behavior) and a device is not manually aligned with a device dashboard, the dashboard that is defined as the "Global Default" is displayed.

**NOTE:** Although you can align a device dashboard with a Dynamic Application, the device dashboards that are aligned with Dynamic Applications are never displayed in the **Device Summary** page as the default display. However, from the **Device Summary** page, a user can select and view any device dashboards that are aligned with Dynamic Applications for the device.

To define the Global Default for device dashboards:

1. Go to the **Device Dashboards** page (System > Customize > Device Dashboards).
2. In the **Device Dashboards** page, select the checkbox for the dashboard you want to define as the Global Default.

- In the **Select Action** drop-down list, select *Set Global Default Device Dashboard*.

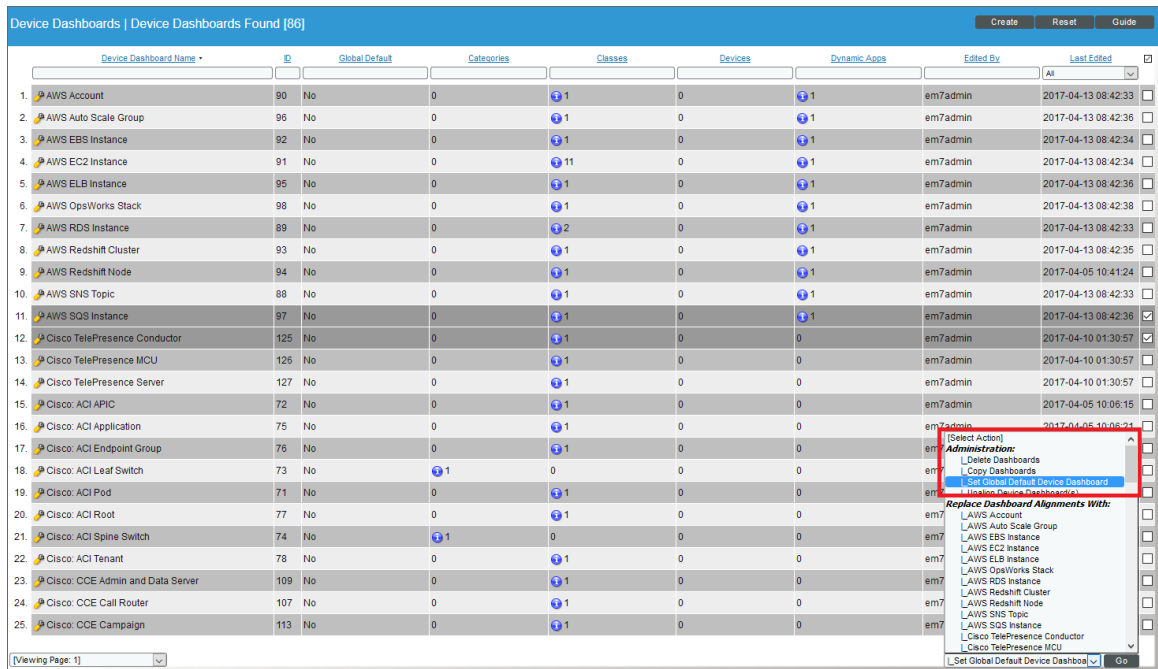

- Click the **[Go]** button. In the **Global Default** field for the selected device dashboard the value "Yes" will appear.

## Unaligning a Device Dashboard

If you no longer want a device dashboard to appear as an option in the **Device Summary** page for any devices, you can remove all alignments for that device dashboard. To do this:

- Go to the **Device Dashboards** page (System > Customize > Device Dashboards).
- In the **Device Dashboards** page, select the checkbox for the dashboard you want to remove from the **Device Summary** page.

- In the **Select Action** drop-down list, select *Unalign Device Dashboard(s)*.

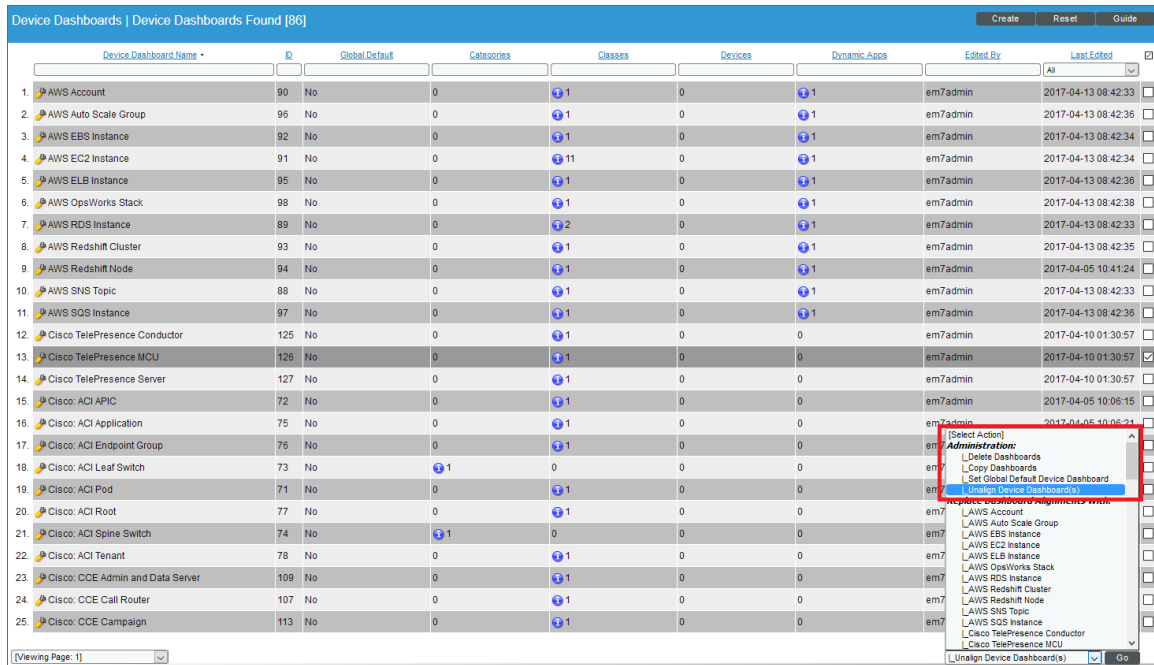

- Click the **[Go]** button.
- The selected dashboards are no longer aligned with Device Categories, Device Classes, Devices, or Dynamic Applications. The selected dashboards will no longer appear as an option in the **Device Summary** page for any devices.

## Moving Alignment for Device Dashboards

You can specify that you want a device dashboard to "steal" all the alignments from another device dashboard. When you do this, the device dashboard that is stolen from will no longer have any alignment. To move alignments from one dashboard to another:

- Go to the **Device Dashboards** page (System > Customize > Device Dashboards).
- In the **Device Dashboards** page, select the checkbox for the dashboard that you want to "steal" alignments.



- In the **Select Action** drop-down list, select *Replace Dashboard Alignments with* and then select the device dashboard that you want to "steal" alignments from.

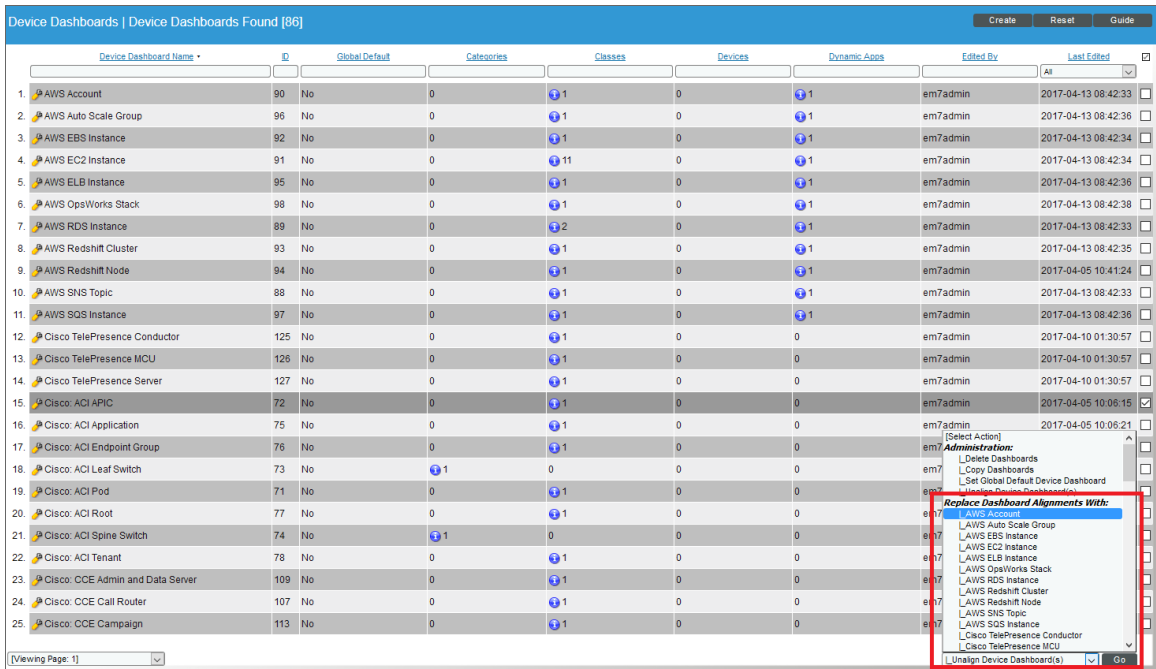

- Click the **[Go]** button.
- The **Device Dashboards** page shows that the alignments have been removed from the device dashboard that you chose in the **Select Action** drop-down. In the **Device Dashboards** page, the device dashboard for which you selected the checkbox now displays all the alignments that it "stole" from the other device dashboard.

---

# Chapter

# 17



## Using Custom Attributes

---

### Overview

This chapter describes how to use custom attributes.

Use the following menu options to navigate the SL1 user interface:

- To view a pop-out list of menu options, click the menu icon ().
- To view a page containing all of the menu options, click the Advanced menu icon ().

This chapter includes the following topics:

<b>Custom Attributes</b> .....	<b>307</b>
<b>Viewing the List of Custom Attributes</b> .....	<b>307</b>
<i>Filtering the List of Custom Attributes</i> .....	310
<i>Viewing the List of Subscribers for a Custom Attribute</i> .....	310
<b>Creating Custom Attributes</b> .....	<b>312</b>
<i>Deleting One or More Custom Attributes</i> .....	313
<b>Adding Custom Attributes for a Device</b> .....	<b>313</b>
<i>Adding Custom Attributes for a Device in the Classic SL1 User Interface</i> .....	315
<b>Custom Attributes in the ScienceLogic API</b> .....	<b>315</b>
<b>Using the ScienceLogic API to View, Create, and Edit Custom Attributes</b> .....	<b>315</b>
<b>Using a Dynamic Application to Create and/or Populate Custom Attributes</b> .....	<b>316</b>
<b>Using Custom Attributes to Define Device Groups</b> .....	<b>318</b>
<b>Viewing Custom Attributes in the Custom Table Widget</b> .....	<b>319</b>

---

## Custom Attributes

**Custom Attributes** are name-value pairs. You can use custom attributes to add custom descriptive fields to assets, devices, interfaces, themes, and vendors. In SL1, you can create and update custom attributes via the API, in configuration Dynamic Applications, and in the **Custom Attribute Manager** page. Custom attributes can be used to dynamically define device groups and can be viewed with the custom table widget.

There are two categories of custom attributes:

- **Base Custom Attributes.** These custom attributes are applied to each member of an element type. For example, a base attribute for devices would be applied to all devices.
- **Extended Custom Attributes.** These custom attributes are applied individually to one or more members of an element type. For example, you could apply the custom attribute `cisco_ios_version` only to those asset records for Cisco devices; you would not want to assign this custom attribute to all asset records.

---

## Viewing the List of Custom Attributes

The **Custom Attribute Manager** page (Manage > Custom Attributes) displays a list of all the existing custom attributes created through the user interface:

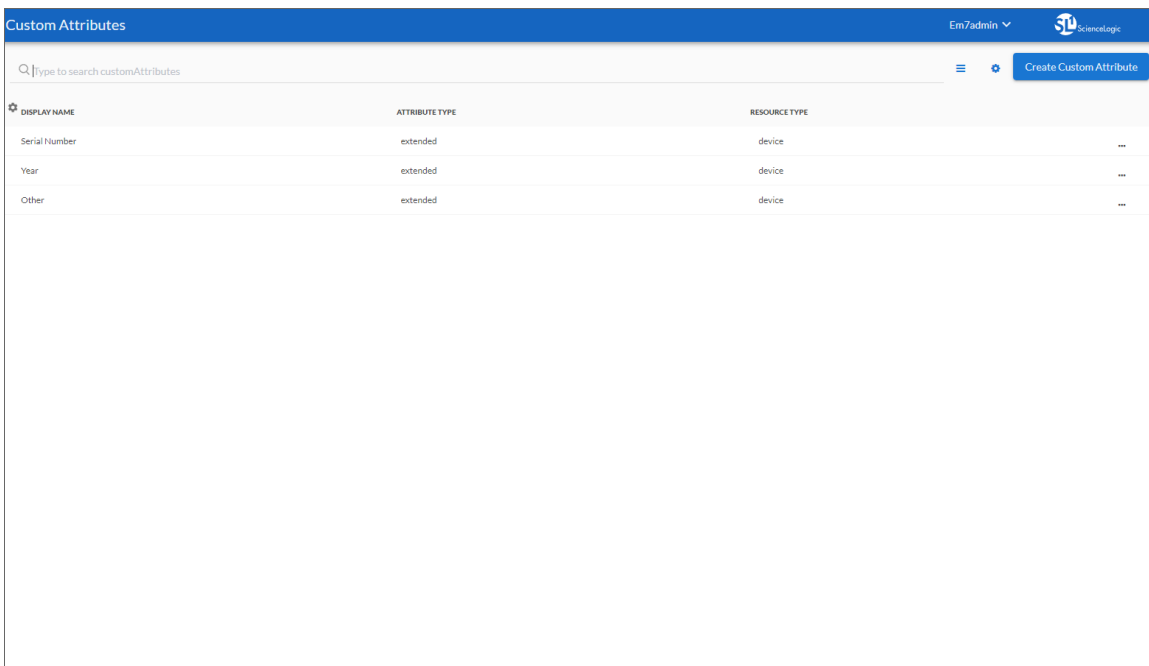

DISPLAY NAME	ATTRIBUTE TYPE	RESOURCE TYPE
Serial Number	extended	device
Year	extended	device
Other	extended	device

The same information is available on the classic **Custom Attribute Manager** page (System > Manage > Custom Attributes):

Custom Attribute Manager | Attributes Found[3] Reset Guide

	Display Name	Internal Field Name	Value Type	Resource Type	Attribute Type	Database Index	Subscribers	
1.	Other	Other	String	Device	Extended	None	--	<input type="checkbox"/>
2.	Serial Number	Serial_20_Number	String	Device	Extended	None	--	<input type="checkbox"/>
3.	Year	Year	String	Device	Extended	None	--	<input type="checkbox"/>
	Required field	required field	[ String ]	[ Please Select: ]	[ Extended ]	[ None ]		

[ Select Action ] Go

For each custom attribute, the **Custom Attribute Manager** page displays the following information:

- **Display Name.** Name for the custom attribute. This value appears in the user interface.
- **Internal Field Name** (classic only). Name for the custom attribute that complies with XML naming rules. If the value in the **Display Name** field does not comply with XML rules, SL1 will convert the value to a name that complies with XML rules.

**NOTE:** Names for custom attributes must conform to XML naming standards. The attribute name can contain any combination of alphanumeric characters, a period, a dash, a combining character, or an extending character. If a value in the **Display Name** column does not conform to XML standards, SL1 will replace non-valid characters with an underscore plus the hexadecimal value of the illegal character plus an underscore. So "serial number" would be replaced with "serial\_X20\_number".

- **Value Type** (classic only). Specifies the type of value that will be saved in the custom attribute. Choice are:
  - *String*. Non-numeric value
  - *Integer*. Numeric value
- **Resource Type.** Specifies the ScienceLogic element that will use the custom attribute. Choices are:
  - *Asset*. Custom attribute will be associated with one or more asset records.
  - *Device*. Custom attribute will be associated with one or more devices.
  - *Interface*. Custom attribute will be associated with one or more network interfaces.

- *Theme*. Custom attribute will be associated with one or more user-interface themes.
- *Vendor*. Custom attribute will be associated with one or more vendor records.

- **Attribute Type**. Specifies the behavior of the custom attribute. Choices are:

- *Base*. A base custom attribute is automatically aligned to all members of the specified **Resource Type**. For example, a base custom attribute for devices would be aligned with each and every device in your SL1 System.
- *Extended*. An extended custom attribute is manually assigned only to some members of the **Resource Type** and should not be assigned to all members of the **Resource Type**. For example, you could apply the custom attribute `cisco_ios_version` only to those asset records for Cisco devices; you would not want to assign this custom attribute to all asset records.

- **Database Index** (classic only). Specifies how the custom attribute is stored in the ScienceLogic database. Choices are:



- *None*. Custom attribute is not indexed.



**NOTE:** Extended custom attributes allow only the value *None* in this field.

- *Unique*. For base custom attributes, ensures that the value of each base custom attribute is unique within its **Resource Type**.
- *Index*. For base custom attributes, allows SL1 to efficiently search for custom attributes in the ScienceLogic database.

- **Subscribers** (classic only). Specifies the **Resource Type** and number of subscribers. Possible values in this field include:

**NOTE:** For base custom attributes, the value in the **Subscribers** column is always "- -" (dash dash).

-  (*Asset*). Custom attribute is associated with one or more asset records. Clicking on the icon displays the **Custom Attribute Subscribers** page, where you can view details about each subscriber of type Asset.
-  (*Device*). Custom attribute is associated with one or more devices. Clicking on the icon displays the **Custom Attribute Subscribers** page, where you can view details about each subscriber of type Device.
-  (*Interface*). Custom attribute is associated with one or more network interfaces. Clicking on the icon displays the **Custom Attribute Subscribers** page, where you can view details about each subscriber of type Interface.

-  (Theme). Custom attribute is associated with one or more user-interface themes. Clicking on the icon displays the **Custom Attribute Subscribers** page, where you can view details about each subscriber of type Theme.
-  (Vendor). Custom attribute is associated with one or more vendor records. Clicking on the icon displays the **Custom Attribute Subscribers** page, where you can view details about each subscriber of type Vendor.

## Filtering the List of Custom Attributes

You can filter the list on the **Custom Attribute Manager** page by one or more parameters. Only attributes that meet all the filter criteria will be displayed in the **Custom Attribute Manager** page.

To filter by parameter, enter text into the desired filter-while-you-type field. The **Custom Attribute Manager** page searches for attributes that match the text, including partial matches. By default, the cursor is placed in the left-most filter-while-you-type field. You can use the <Tab> key or your mouse to move your cursor through the fields. The list is dynamically updated as you type. Text matches are not case-sensitive.

You can also use *special characters* to filter each parameter.





Filter by one or more of the following parameters:

- **Display Name.** You can enter text to match, including special characters, and the **Custom Attribute Manager** page will display only custom attributes that have a matching display name.
- **Internal Field Name.** You can enter text to match, including special characters, and the **Custom Attribute Manager** page will display only custom attributes that have a matching internal field name.
- **Value Type.** You can enter text to match, including special characters, and the **Custom Attribute Manager** page will display only custom attributes that have a matching value type.
- **Resource Type.** You can enter text to match, including special characters, and the **Custom Attribute Manager** page will display only custom attributes that have a matching resource type.
- **Attribute Type.** You can enter text to match, including special characters, and the **Custom Attribute Manager** page will display only custom attributes that have a matching attribute type.
- **Database Index.** You can enter text to match, including special characters, and the **Custom Attribute Manager** page will display only custom attributes that have a matching database index.
- **Subscribers.** You can enter text to match, including special characters, and the **Custom Attribute Manager** page will display only custom attributes that have a matching number of subscribers.

## Viewing the List of Subscribers for a Custom Attribute

To view a list of subscribers for a custom attribute:

1. Go to the **Custom Attribute Manager** page (System > Manage > Custom Attributes) .
2. Click the icon in the **Subscribers** column.
3. The **Custom Attribute Subscribers** modal page appears.

- For  (Asset), the **Custom Attribute Subscribers** modal page displays the following for each subscriber:
  - **Make**. Make of the asset.
  - **Model**. Model of the asset.
  - **Device**. If applicable, name of the device associated with the asset record.
  - **Asset Tag**. Asset tag associated with the asset.
  - **Name of the custom attribute**. The value assigned to the custom attribute for this subscriber.
  
- For  (Device), the **Custom Attribute Subscribers** modal page displays the following for each subscriber:
  - **DID**. Device ID for the device. SL1 automatically assigns this value to the device.
  - **Device Name**. Name of the device.
  - **IP Address**. If applicable, the IP address associated with the device.
  - **Name of the custom attribute**. The value assigned to the custom attribute for this subscriber.
  
- For  (Interface), the **Custom Attribute Subscribers** modal page displays the following for each subscriber:
  - **Device Name**. Name of the device associated with the interface.
  - **IF Name**. Name of the interface.
  - **IF Port**. Port number associated with the interface.
  - **Alias**. Alias associated with the interface.
  - **Name of the custom attribute**. The value assigned to the custom attribute for this subscriber.
  
- For  (Theme), the **Custom Attribute Subscribers** modal page displays the following for each subscriber:
  - **ID**. Unique ID associated with the theme. SL1 automatically assigns this value to the theme.
  - **Theme Name**. Name of the theme.
  - **HTML Header/Title**. HTML header associated with the theme.
  - **Name of the custom attribute**. The value assigned to the custom attribute for this subscriber.
  
- For  (Vendor), the **Custom Attribute Subscribers** modal page displays the following for each subscriber:
  - **ID**. Unique ID associated with the vendor. SL1 automatically assigns this value to the vendor.
  - **Vendor Name**. Name of the vendor.
  - **Name of the custom attribute**. The value assigned to the custom attribute for this subscriber.

---

## Creating Custom Attributes

You can create custom attributes on the **Custom Attribute Manager** page, via the ScienceLogic API, or by using a configuration Dynamic Application. The following rules apply to the creation of custom attributes:

- If you define a base custom attribute for devices on the **Custom Attribute Manager** page, that base custom attribute is aligned with each device in your system. The value of the base custom attribute will be null until you assign a value for each device.
- If you define an extended custom attribute for devices on the **Custom Attribute Manager** page, that extended custom attribute is not aligned with any devices.
- You can use the **Attributes** page in the **Device Administration** panel to assign a value or edit the value for each custom attribute aligned with a device. For more information, see the section on [Managing a Single Device with the Device Administration Panel](#).
- You can use Dynamic Applications of type "configuration" to create custom attributes and/or assign values to custom attributes for devices. For details, see the section on [Using a Dynamic Application to Create and/or Populate Custom Attributes](#).
- If you create a base custom attribute for asset records, network interfaces, themes, and vendor records, those custom attributes will appear in the ScienceLogic API for the specified entity. Initially, the value of the base attribute will be null. You cannot use the ScienceLogic user interface to assign a value to these base custom attribute. You must use the ScienceLogic API to assign values to these base custom attribute. For details, see the section on [Custom Attributes in the ScienceLogic API](#).
- If you create an extended custom attribute for asset records, network interfaces, themes, and vendor records, those custom attributes can be aligned and populated using the ScienceLogic API. You cannot use the ScienceLogic user interface to assign a value to these extended custom attributes. You must use the ScienceLogic API to assign values to these extended custom attributes. For details, see the section on [Custom Attributes in the ScienceLogic API](#).



To create a custom attribute from the **Custom Attribute Manager** page:

1. Go to the **Custom Attribute Manager** page (System > Manage > Custom Attributes).

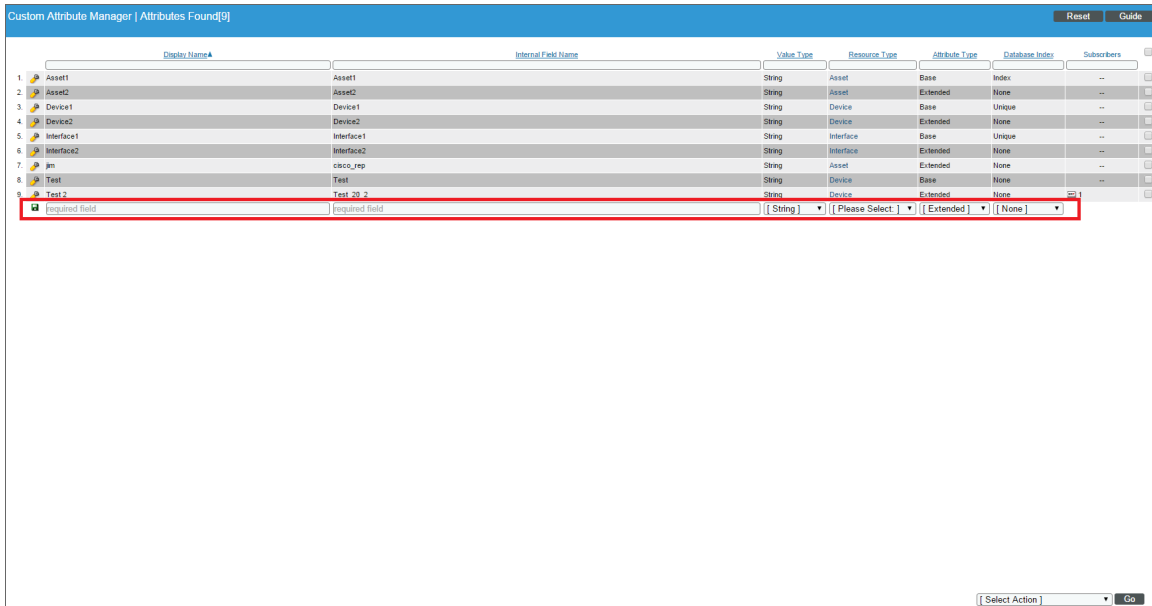

2. In the bottom-most row, enter a value in each field.
3. Click the **Save** icon (  ).

## Deleting One or More Custom Attributes

From the **Custom Attribute Manager** page, you can delete custom attributes from SL1. To do this:

1. Go to the **Custom Attribute Manager** page (System > Manage > Custom Attributes).
2. Select the checkbox (  ) for each custom attribute you want to delete.
3. Click the **Select Action** field in the lower-right and select *DELETE Custom Attributes*.
4. Click the **[Go]** button.

**NOTE:** SL1 will not allow you to delete an extended custom attribute that is aligned with one or more subscribers. If you try to delete an extended custom attribute that is aligned with one or more subscribers, SL1 will display the error message: "Error: Some attributes have entities aligned. Unalign entity from attribute before deleting." This message appears to the right of the page title.

## Adding Custom Attributes for a Device

You can view detailed data about a specific device by clicking the device name on the **Devices** page (  ) to open the **Device Investigator** page for that device.

On the **[Attributes]** tab of the **Device Investigator**, you can view a list of list of custom attributes that are already aligned with that device, and you can also add and remove extended custom attributes for the device:

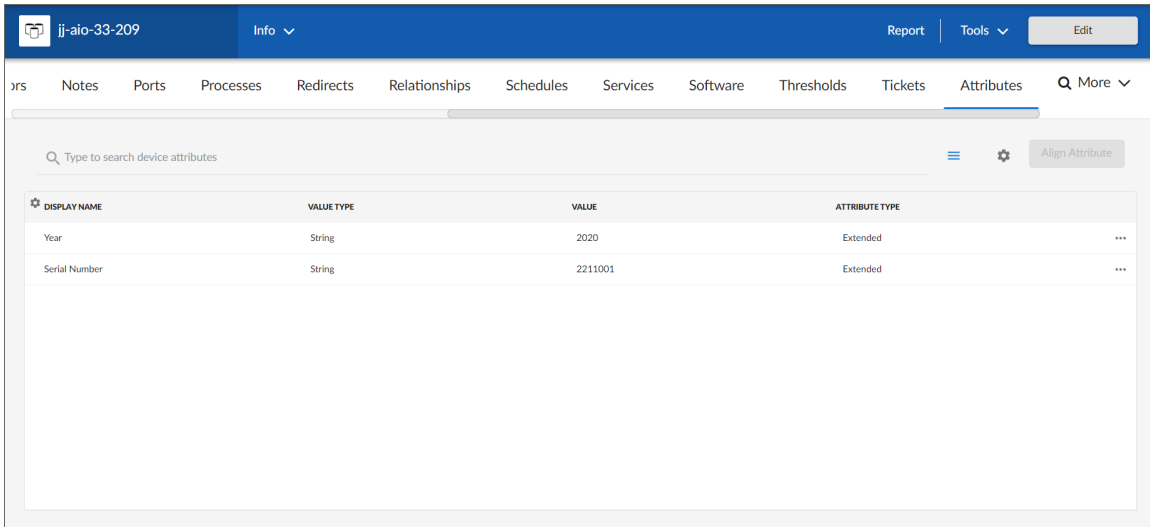

**NOTE:** Before you can add a custom attribute to a device, you might need to create that custom attribute on the **Custom Attribute Manager** page (Manage > Custom Attributes) or on the classic **Custom Attribute Manager** page (System > Manage > Custom Attributes).

To add and edit custom attributes for a device on the **[Attributes]** tab:

1. On the **[Attributes]** tab for the device, click **[Edit]** and then click **[Align Attribute]**. The **Align Extended Attribute** window appears.
2. Complete the following fields:
  - **Attributes.** Select the name of the custom attribute.
  - **Attribute value.** Specify a text or numeric value for the attribute, based on its value type.
3. Click **[Align Attribute]**. The custom attribute is added to the list on the **[Attributes]** tab.
4. To edit an attribute in the list, click the **[Actions]** button (≡) for that attribute and select *Edit Attribute*.
5. To unalign an attribute, click the **[Actions]** button (≡) for that attribute and select *Unalign Attribute*.
6. When you are done adding, editing, or unaligning attributes, click **[Save]**.

**NOTE:** Upon saving, your attribute changes will be reflected in the **More Attributes** section of the **Info drop-down**.

## Adding Custom Attributes for a Device in the Classic SL1 User Interface

For information about how to add custom attributes for a device in the classic SL1 user interface, see the section on [Aligning Custom Attributes with a Device](#).

---

## Custom Attributes in the ScienceLogic API

The ScienceLogic API includes resources for adding custom attributes to the following resources:

- /asset
- /device
- The /interface sub-resource under /device resources
- /theme
- /vendor

When you define a custom attribute for a resource:

- For any instance of that resource (e.g., a specific device), you can perform a POST operation specifying a value for that attribute for that instance.
- If you configure the attribute as a base attribute, the attribute will appear in the list of fields for all instances of that resource. For example, if you define a custom attribute as a base attribute for the /device resource, the response to a GET request for any /device/device\_id resource includes the custom attribute in the list of fields.
- If you configure the attribute as an extended attribute, the attribute will appear in the list of fields for instances of that resource only if a value has been specified for the attribute for that instance. For example, suppose you define a custom attribute as an extended attribute for the /device resource. The response to a GET request on the /device resource index with the extended\_fetch option enabled will include the custom attribute only for devices that have a value for that custom attribute.
- GET requests for the resource index can include filter and sort criteria that use that custom attribute.

When you define a value for a custom attribute by performing a POST request to a resource, the value is available through the API and can be used in dynamic rules for device groups and viewed in the custom table widget.

---

## Using the ScienceLogic API to View, Create, and Edit Custom Attributes

You can use the ScienceLogic API to view, edit, and create custom attributes. For details on viewing, creating, and editing custom attributes, see the manual [Using the ScienceLogic API](#).

## Using a Dynamic Application to Create and/or Populate Custom Attributes

For details on creating a Dynamic Application or creating collection objects, see the manual *Dynamic Application Development*.

One of the ways you can create and/or populate a custom attribute for devices is through a Dynamic Application of type *configuration*.

In Dynamic Applications of archetype *configuration*, you can:

- Use a collection object to populate the value of an existing custom attribute.
- Use a pair of collection objects to create a custom attribute and provide a value for that custom attribute. You must define a collection object to define the name of the custom attribute; this causes the SL1 system to create a custom attribute with the name from the collection object. You must also define a second collection object to populate the value of the custom attribute.

**NOTE:** For details on creating and managing custom attributes, see the manual *Using the ScienceLogic API*.

The following fields in the **Collection Objects** page allow you to use one or more collection objects to define and/or populate a custom attribute:

The screenshot shows a configuration form for a collection object. The 'Object Name' field is circled in red and contains the text 'dyn\_val'. Below it, the 'XML Tags' field contains '<tags><tag><shape>'. The 'Class Type' dropdown is set to '[10 Config Character]'. The 'String Type' dropdown is set to '[Standard]'. The 'Custom Attribute' dropdown is circled in red and set to 'Dynamic Value'. The 'dyn\_key' dropdown is also circled in red and set to 'dyn\_key'. Other fields include 'Group / Usage Type' (set to '[Group 1]'), 'Asset / Form Link' (set to '[None]'), 'Inventory Link' (set to '[Disabled]'), 'Change Alerting' (set to '[Disabled]'), and 'Table Alignment' (set to '[Left]'). A 'Hide Object' checkbox is present and unchecked. At the bottom, there is a 'Save' button and a 'Disable Object Maintenance' checkbox which is unchecked.

- **Align to Custom Attribute.** Specify the custom attribute to associate with this collection object. The custom attribute will be populated with a value from a collection object. Choices are:
  - *None.* This collection object is not associated with a custom attribute.
  - *Static.* This collection object is associated with a specific custom attribute.

- **Static Name.** If you selected *Static* in the **Custom Attribute** field, the *Static Name* field appears. In this field, specify the name of the custom attribute that you want to populate with the value of the collection object. You can select from a list of existing custom attributes.
  - If the list does not include the custom attribute you want to align with the collection, select the plus-sign icon (). The icon clears the field and allows you to manually enter a value.
  - If you manually specify a custom attribute, SL1 will search for a custom attribute with a matching name and populate the custom attribute with the value of this collection object. If SL1 does not find a custom attribute with a matching name and therefore creates the custom attribute, the new custom attribute will be an extended custom attribute, for devices. The data type will be integer (for numeric values) or string (for all other value types).
- **Dynamic Name.** You can use a pair of collection objects to populate the name and value of a custom attribute. You must define each collection object separately. When you select *Dynamic Name* in the **Custom Attribute** field, the name of the custom attribute is populated with the value of the collection object. If SL1 does not find a custom attribute with a matching name, SL1 will create the custom attribute. If SL1 does not find a custom attribute with a matching name and therefore creates the custom attribute, the new custom attribute will be an extended custom attribute, for devices. The data type will be integer (for numeric values) or string (for all other value types).

**NOTE:** If you select *Dynamic Name* in the **Custom Attribute** field, you must create a second collection object that will populate the value of the custom attribute.

**NOTE:** Names for custom attributes must conform to XML naming standards. The attribute name can contain any combination of alphanumeric characters, a period, a dash, a combining character or an extending character. If a collected value for an attribute name does not conform to XML standards, SL1 will replace non-valid characters with an underscore + the hexadecimal value of the illegal character + an underscore. So "serial number" would be replaced with "serial\_X20\_number". The attribute label will use the original, non-converted value ("serial number").

- **Dynamic Value.** The value of the custom attribute selected in the *Dynamic Name* field is populated with the value of the collection object.
- **Dynamic Name.** If you selected *Dynamic Value* in the **Custom Attribute** field, the *Dynamic Name* field appears. Select from the list of collection objects that have a **Custom Attribute** value of *Dynamic Name*.

**NOTE:** The collection object assigned to the *Dynamic Value* is added to the same **Group** as the collection object assigned to the associated *Dynamic Name*. If the collection object for *Dynamic Name* is not assigned to a **Group**, you will be prompted to select a **Group** for the both the collection object for *Dynamic Name* and the collection object for *Dynamic Value*.

**NOTE:** Each group can contain only one collection object that is assigned to a *Dynamic Value* and only one collection object that is assigned to a *Dynamic Name*. The group can contain other collection objects, but should not contain more than one collection object assigned to a *Dynamic Value* and not more than one collection object assigned to a *Dynamic Name*.

---

## Using Custom Attributes to Define Device Groups

A device group is a group of multiple devices, grouped together for ease of management. You can use custom attributes to define membership in a device group. Only devices that have a specific value for a custom attribute will be included in the device group.

You can add devices to a device group either explicitly or dynamically.

- You can create **static device groups**, where you explicitly assign one or more devices to a device group.
- You can create **dynamic device groups**, where you define **rules** for the device group. Each device that meets the criteria in the rule is automatically included in the device group. For example, suppose that you define a rule that specifies "include all devices in the System organization, with an IP address that starts with '10.100.100' ". SL1 would automatically assign all devices from the System organization with an IP of "10.100.100.\*" to the new device group. When a new device is added to the System organization with an IP that begins with "10.100.100.\*", that device will also be included in the device group. If a device with an IP that starts with "10.100.100" is removed from the System organization, that device will also be removed from the device group.
- You can create a device group that includes both explicitly assigned devices and also includes a dynamic rule. This device group will include both the explicitly assigned devices and all devices that meet the criteria in the dynamic rule.

In the **Device Group Rule Editor** page, the **Active Selectors** field includes an entry for each custom attribute you have defined with the API or with a Dynamic Application. When you select a custom attribute, the **Selector Definitions** pane displays a field in which you can enter a string. SL1 will use the string to search for devices that have a matching value for this custom attribute.

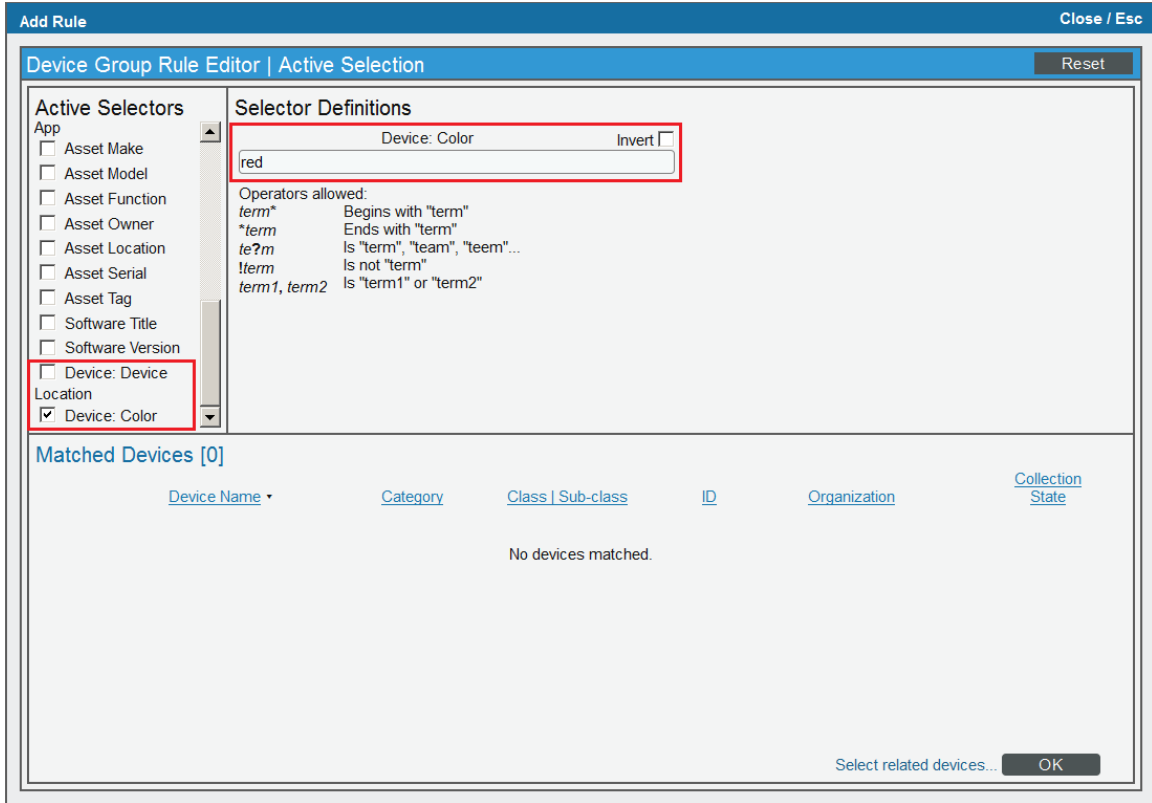

In the example above, we selected the custom attribute *Device:Color* and specified the value *red*. Our device group will include only devices that have the value *red* assigned to the *Device:Color* custom attribute.

For additional details on defining device groups and defining device group rules, see the manual **Device Groups and Device Templates**.

## Viewing Custom Attributes in the Custom Table Widget

A dashboard is a page that displays one or more graphical reports, called widgets. SL1 includes pre-defined widgets that can be customized and displayed in the **Classic Dashboards** page. These widgets are displayed in their own pane, and display graphs, tables, and/or text.

To define an instance of a widget, you first select from a list of pre-defined widget definitions, and then customize what will be displayed by the selected widget by supplying values in the option fields provided by that widget.

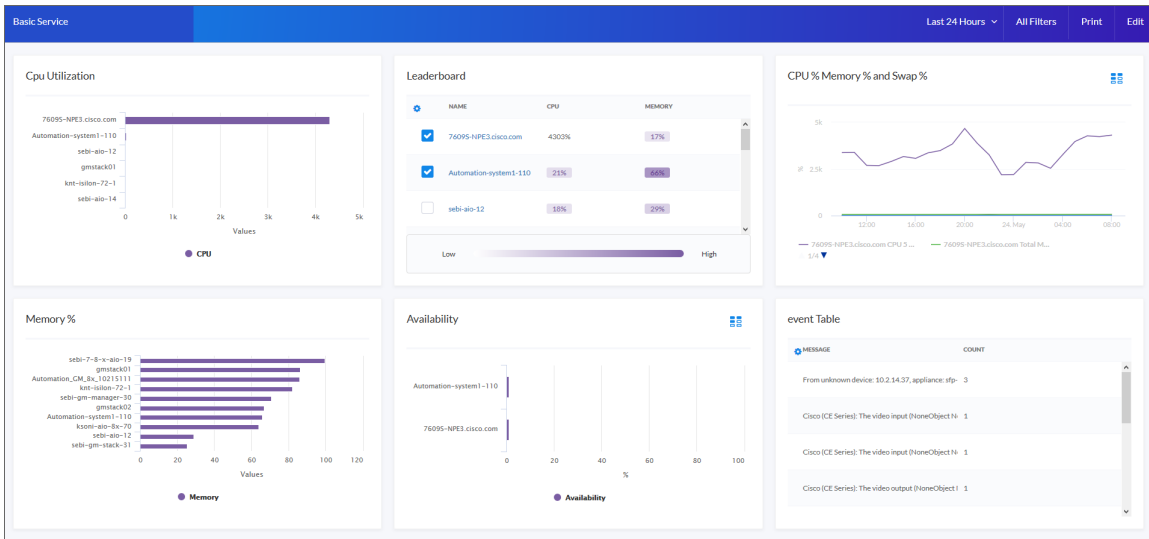

The **Custom Table** widget displays multiple instances of an entity in a table. The **Custom Table** widget can be configured to display a list of devices, device classes, or device groups (and also other entities).

The generated table displays information about each entity in the list. You can configure which information is included in the table in the **Layout Editor** pane during configuration.

The 'New Widget Configuration' dialog box shows the 'Custom Table' widget selected. The 'Layout Editor' panel displays a table with columns for 'Device Name', 'IP Address', 'Current State', 'Organizational Group', 'Device Class', 'Sub-Class', 'Avail', 'Latency', 'CPU', 'Mem', 'Swap', 'Data Time', 'Last Poll', 'Date Added', 'Color', and 'Device Location'. The 'Color' and 'Device Location' columns are highlighted with red boxes, indicating they are custom attributes.

ID	Device Name	IP Address	Current State	Organizational Group	Device Class	Sub-Class	Avail	Latency	CPU	Mem	Swap	Data Time	Last Poll	Date Added	Color	Device Location
1	em7_db	10.0.9.147	Healthy	System	CUG116	ScienceLo	--	--	--	--	--	2015-05-08 09:00	2015-04-07	--	--	--
2	em7_js	10.0.9.227	Healthy	System	CUG116	ScienceLo	--	--	--	--	--	2015-05-08 12:44	2015-04-07	--	--	--
3	em7	10.0.9.145	Healthy	System	CUG116	ScienceLo	--	--	--	--	--	2015-05-08 09:00	2015-04-07	--	--	--
4	em7_io	10.0.9.146	Healthy	System	CUG116	ScienceLo	--	--	--	--	--	2015-05-08 09:00	2015-04-07	--	--	--
5	MiukkoDB	10.0.9.144	Healthy	System	CUG116	ScienceLo	--	--	--	--	--	2015-05-08 09:00	2015-04-07	--	--	--

The **Layout Editor** panel displays the columns that will be displayed in the widget.

In the example above, *Color* and *Device Location* are custom attributes for devices.

If you selected *Device*, or *Asset*, or *Interface* in the **Entity Type** field of the Custom Table Widget, the Layout Editor will include columns for the custom attributes defined in your system for that entity type.



- By default, the columns for the custom attributes are excluded from the configuration.
- If an extended custom attribute is defined in your system but has not been assigned a value for any asset, device, or interface, it will not appear in the list of columns.

You can add or remove custom attributes from the layout of the widget using the following buttons:

- **<|>** You can move columns from left to right by clicking on the arrow characters at the top of each column and dragging the column left or right. Double-clicking on the arrow moves the column out of the display past a black bar to the right. All disabled columns can be seen to the right of the black bar. Double-clicking on the arrow again moves the column back into the display.

For additional details on configuring the Custom Table Widget, see the **Dashboards** manual.

© 2003 - 2020, ScienceLogic, Inc.

All rights reserved.

#### LIMITATION OF LIABILITY AND GENERAL DISCLAIMER

ALL INFORMATION AVAILABLE IN THIS GUIDE IS PROVIDED "AS IS," WITHOUT WARRANTY OF ANY KIND, EITHER EXPRESS OR IMPLIED. SCIENCELOGIC™ AND ITS SUPPLIERS DISCLAIM ALL WARRANTIES, EXPRESS OR IMPLIED, INCLUDING, BUT NOT LIMITED TO, THE IMPLIED WARRANTIES OF MERCHANTABILITY, FITNESS FOR A PARTICULAR PURPOSE OR NON-INFRINGEMENT.

Although ScienceLogic™ has attempted to provide accurate information on this Site, information on this Site may contain inadvertent technical inaccuracies or typographical errors, and ScienceLogic™ assumes no responsibility for the accuracy of the information. Information may be changed or updated without notice. ScienceLogic™ may also make improvements and / or changes in the products or services described in this Site at any time without notice.

#### Copyrights and Trademarks

ScienceLogic, the ScienceLogic logo, and EM7 are trademarks of ScienceLogic, Inc. in the United States, other countries, or both.

Below is a list of trademarks and service marks that should be credited to ScienceLogic, Inc. The ® and ™ symbols reflect the trademark registration status in the U.S. Patent and Trademark Office and may not be appropriate for materials to be distributed outside the United States.

- ScienceLogic™
- EM7™ and em7™
- Simplify IT™
- Dynamic Application™
- Relational Infrastructure Management™

The absence of a product or service name, slogan or logo from this list does not constitute a waiver of ScienceLogic's trademark or other intellectual property rights concerning that name, slogan, or logo.

Please note that laws concerning use of trademarks or product names vary by country. Always consult a local attorney for additional guidance.

#### Other

If any provision of this agreement shall be unlawful, void, or for any reason unenforceable, then that provision shall be deemed severable from this agreement and shall not affect the validity and enforceability of any remaining provisions. This is the entire agreement between the parties relating to the matters contained herein.

In the U.S. and other jurisdictions, trademark owners have a duty to police the use of their marks. Therefore, if you become aware of any improper use of ScienceLogic Trademarks, including infringement or counterfeiting by third parties, report them to Science Logic's legal department immediately. Report as much detail as possible about the misuse, including the name of the party, contact information, and copies or photographs of the potential misuse to: [legal@sciencelogic.com](mailto:legal@sciencelogic.com)



800-SCI-LOGIC (1-800-724-5644)

International: +1-703-354-1010