



Installation and Initial Configuration

ScienceLogic version 8.10.1

Table of Contents

Introduction	1
Preparing to Install a Hardware Appliance	1
Required Ports	2
Initial Configuration for Hardware Appliances	3
Initial Configuration	4
Changing the Password for em7admin	4
Changing Network Settings	4
Installing an Appliance as a Virtual Machine	7
Virtual Machine Specifications	9
Deploying a ScienceLogic System on Virtual Machines	9
Building an Appliance on a VMware System	9
Building an Appliance on a Hyper-V System	11
Installing the Database Server	20
Installing the Administration Portal, Data Collector and/or Message Collector	24
Installing VMware Tools	27
Installing VMware Tools Using Yum	27
Installing VMware Tools Manually	28
Licensing and Configuring an Appliance	29
Logging in to the Web Configuration Utility	30
Changing the Password for the Web Configuration Utility	31
Licensing and Configuring a Database Server or All-In-One Appliance	32
Configuring an Administration Portal	33
Configuring a Data Collector or Message Collector	34
Register the Data Collector or Message Collector with the Database Server	35
Defining the Syslog Server	38
Defining the NTP Server	39
Creating a Bonded Interface	40
Defining a Proxy Server	43
Configuring the ScienceLogic Platform for PhoneHome Communication	46
What is PhoneHome Communication?	47
Prerequisites	49
Overview of the PhoneHome Configuration	49
Configuring the Database Server for PhoneHome	50
Configuring the Data Collectors and Message Collectors for PhoneHome	51
Registering the Data Collectors and Message Collectors	56
Define the Database Server for Each Collector	56
Register the Collectors with the Main Database Server	57
Defining Port Forwarding	58
Importing and Exporting a PhoneHome Configuration	59
Using Custom Options for AutoSSH	59
Configuring PhoneHome for High Availability and Disaster Recovery	60
What is the Control Node?	61
Configuring the Control Node Database Server for High Availability and Disaster Recovery	61
Configuring the Secondary Database Server for High Availability and Disaster Recovery	62
Configuring Data Collectors and Message Collectors for High Availability and Disaster Recovery	63
Syncing the High Availability and Disaster Recovery System	64
Changing the Control Node for High Availability and Disaster Recovery	64
Adding a New Secondary Database Server	65
Configuring One or More Proxy Servers	65
Editing ssh_config	66

Configuring Data Collectors that Connect to the PhoneHome Database Server Through a Proxy	68
Copying the SSH key to Each Proxy	69
Synchronize the Data Collectors with the Database Server	69
The Watchdog Service	70
Logging PhoneHome Configuration Information	71
Using the Command-Line Interface	71
The phonehome Command	71
Troubleshooting the PhoneHome Configuration	77
Best Practices	77
Basic Troubleshooting	78
Verifying the Control Node	79
Deploying ScienceLogic Appliances in the Amazon Cloud	81
Prerequisites	82
What is an AWS AMI?	82
What are the ScienceLogic AMIs?	83
Instance Specifications	83
Deploying a ScienceLogic System in AWS	83
Getting the ScienceLogic AMI	83
Launching the New Instance	86
Security Rules for Each Appliance Type	94
All-In-One Appliance	94
Database Server	97
Administration Portal	99
Data Collector	101
Message Collector	103
Additional Configuration Steps	105
Assigning an EIP to the New Instance	106
Accessing the Appliance Using SSH	109
Gathering Information Required for Accessing the Appliance Using SSH	109
Configuring SSH	109
UNIX and LINUX Users	110
Windows Users	110
Web Configuration Tool	110
Rebooting Data Collectors and Message Collectors	110
Deploying a ScienceLogic Virtual Machine in Azure	112
System Requirements	113
Deploying a ScienceLogic System in Azure	113
Configuring an Azure Storage Account	114
Uploading a .vhd Image File to an Azure Storage Account	116
Creating an Azure Virtual Machine	117
Setting the Virtual Machine Allocation Method to Static	119
Configuring Ports on ScienceLogic Appliances	121
Configuring the Virtual Machine	123
Troubleshooting	126

Introduction

Overview

This manual describes how to install and configure a ScienceLogic appliance. This manual describes the following general steps to make a ScienceLogic appliance operational:

- If you are installing a hardware-based appliance, *prepare the hardware on which the ScienceLogic platform software is installed.*
- *Ensure that your network firewall settings allow communication on the ports used by ScienceLogic appliances.*
- For hardware-based appliances, *configure the administrator password and network settings at the console of the ScienceLogic appliance.*
- *Installing an appliance as a virtual machine.*
- *Installing an appliance in Microsoft Azure.*
- *License the ScienceLogic appliance and add it to your ScienceLogic system.*

Preparing to Install a Hardware Appliance

Perform the following steps to prepare a ScienceLogic appliance for configuration:

- Install the ScienceLogic appliance in a server rack and connect the power cables according to the instructions provided with the hardware.
- Connect the ScienceLogic appliance to your network.
- Connect a monitor and keyboard to the ScienceLogic appliance.

Required Ports

ScienceLogic appliances must communicate with each other using several network ports for the ScienceLogic system to be operational.

Several network ports are used to communicate with the All-In-One Appliance.

Ensure that your network's firewall settings allow communication using the following ports:

- **Port 80.** This port is used for connections between a user's computer and the Administration Portal, Database Server, or All-In-One Appliance web interface.
- **Port 443.** This port is used for:
 - Secure connections between a user's computer and the Administration Portal, Database Server, or All-In-One Appliance web interface.
 - Secure HTTP connections between an external system and the Integration Server.
- **Port 7700.** This port is used for connections between a user's computer and the Web Configuration Utility on ScienceLogic appliances.
- **Port 7707.** This port is used for connections from the Database Server to Data Collectors and Message Collectors. This port is not used on an All-In-One Appliance.
- **Port 7706.** This port is used for connections between several appliances:
 - In a distributed system, this port is used for connections to the Database Server from Administration Portals and Integration Servers.
 - In a system that uses an All-In-One Appliance, this port is used for connections to the All-In-One Appliance from Integration Servers.

Initial Configuration for Hardware Appliances

Overview

This chapter describes the required configuration steps that must be performed at the console of a ScienceLogic appliance shipped by ScienceLogic.

To complete the initial configuration, you must have the following information ready:

- The primary static IP address of the ScienceLogic appliance
- The network mask for the primary static IP address
- The IP address of the network gateway
- The IP address of a DNS server

This chapter describes:

<i>Initial Configuration</i>	4
<i>Changing the Password for em7admin</i>	4
<i>Changing Network Settings</i>	4

Initial Configuration

You must perform the following tasks during initial configuration of a hardware appliance shipped by ScienceLogic:

- Change the password for the administrative user **em7admin**.
- Change the primary IP address of the appliance.
- Change the netmask for the primary IP address of the appliance.
- Change the IP address for the network gateway.
- Change the IP address for the primary Nameserver.

Changing the Password for em7admin

To change the password for the default administrative user **em7admin** for console logins and SSH access:

1. Either go to the console of the ScienceLogic appliance or use SSH to access the server.
2. Log in as user **em7admin** with the appropriate password. The default password is **em7admin**.
3. At the shell prompt, type the following:

```
passwd
```
4. When prompted, type and re-type the new password.

Changing Network Settings

To change the IP address, Netmask, Gateway addresss, and DNS Server for an appliance in the ifconfig file:

1. Either go to the console of the ScienceLogic appliance or use SSH to access the server.
2. Login as user **em7admin** with the appropriate password.
3. Enter the following at the command line:

```
sudo ifconfig
```

4. Your output will look like this:

```
ens32: flags=4163<UP,BROADCAST,RUNNING,MULTICAST> mtu 1500
inet 10.64.68.20 netmask 255.255.255.0 broadcast 10.64.68.255
inet6 fe80::250:56ff:fe84:455f prefixlen 64 scopeid 0x20<link>
ether 00:50:56:84:45:5f txqueuelen 1000 (Ethernet)
RX packets 1774927 bytes 161985469 (154.4 MiB)
RX errors 0 dropped 861 overruns 0 frame 0
TX packets 1586042 bytes 158898786 (151.5 MiB)
TX errors 0 dropped 0 overruns 0 carrier 0 collisions 0

lo: flags=73<UP,LOOPBACK,RUNNING> mtu 65536
inet 127.0.0.1 netmask 255.0.0.0
inet6 ::1 prefixlen 128 scopeid 0x10<host>
loop txqueuelen 0 (Local Loopback)
RX packets 13406577 bytes 4201274223 (3.9 GiB)
RX errors 0 dropped 0 overruns 0 frame 0
TX packets 13406577 bytes 4201274223 (3.9 GiB)
TX errors 0 dropped 0 overruns 0 carrier 0 collisions 0
```

5. Examine the output, find the first interface in the output, and note its name.
6. Use the vi editor to edit the settings for the interface. To do this, enter the following at the command line:

```
sudo vi /etc/sysconfig/network-scripts/ifcfg-interface name you noted in step #4
```

For example, from our output, we could enter:

```
sudo vi /etc/sysconfig/network-scripts/ifcfg-ens32
```

7. Your output will look like this:

```
TYPE=Ethernet
BOOTPROTO=none
DNS1=10.64.20.33
DEFROUTE=yes
IPV4_FAILURE_FATAL=no
IPV6INIT=yes
IPV6_AUTOCONF=yes
IPV6_DEFROUTE=yes
IPV6_FAILURE_FATAL=no
NAME=ens32
UUID=d471435d-9adf-47c9-b3f3-32f61dccbad8
DEVICE=ens32
ONBOOT=yes
IPADDR=10.64.68.20
PREFIX=24
GATEWAY=10.64.68.1
IPV6_PEERDNS=yes
IPV6_PEERROUTES=yes
```

8. You can edit one or more of the following settings:
 - **DNS1**=IP address of the DNS server that will be used by the ScienceLogic appliance.
 - **IPADDR**=IP address of the ScienceLogic appliance.
 - **PREFIX**=netmask for the ScienceLogic appliance.
 - **GATEWAY**=IP address of the network gateway that will be used by the ScienceLogic appliance.
9. Save your changes and exit the file (:wq)
10. At the command line, enter the following:

```
sudo service network restart
```

Installing an Appliance as a Virtual Machine

Overview

ScienceLogic supports deploying appliances as virtual machines on the following types of hypervisor systems:

- VMware vSphere Hypervisor (ESXi) 4.1
- VMware vSphere Hypervisor (ESXi) 5.0
- VMware vSphere Hypervisor (ESXi) 5.1
- VMware vSphere Hypervisor (ESXi) 5.5
- VMware vSphere Hypervisor (ESXi) 6.0
- Citrix XenServer 5.6
- Citrix XenServer 6.1
- Citrix XenServer 6.2
- Microsoft Windows Server 2008 R2 SP 1 Hyper-V
- Microsoft Windows Server 2012 Hyper-V
- Microsoft Windows Server 2012 R2 Hyper-V
- RedHat/CentOS 6.2 KVM
- Ubuntu 12 and later KVM

NOTE: ScienceLogic strongly recommends a dedicated host for each Database Server VM to ensure predictable performance without resource contention if going beyond 2,500 devices.

NOTE: Database Servers that serve 5,000 or more devices should include solid-state drives. On Database Servers that serve 5,000 or more devices, tiered storage can cause delays to nightly maintenance tasks that require access to data on slower disks.

NOTE: Microsoft Hyper-V Linux Integration software cannot be installed on any ScienceLogic appliances.

NOTE: ScienceLogic licensing relies on appliance MAC addresses and UUIDs remaining intact. VM migrations which change these identifiers (such as storage vMotion with default .vmx settings, or CloudStack orchestration move between XenServer hosts) will invalidate the license, thus limiting or disabling the appliance operation until a new license can be applied.

NOTE: ScienceLogic databases have a very high bandwidth of memory changes under normal operations, often in excess of 10Gb/sec. This rate of memory change limits the feasibility of VM live migration methods (such as vMotion) for ScienceLogic appliances because on moderately large databases, the rate of memory change is too high to be synchronized between hosts over a 10Gb/sec ethernet link.

The following requirements apply to all virtualized appliances:

- Fixed storage is required. Dynamically-expanding storage is not supported.
- Memory over-commit is not supported. In the case of VMware, this means that 100% of memory must be reserved for all ScienceLogic appliances. Running on a virtualization server that is close to capacity might result in unexpected behavior.
- Running on a virtualization server that is close to capacity will result in unexpected behavior.

This chapter describes:

<i>Virtual Machine Specifications</i>	9
<i>Deploying a ScienceLogic System on Virtual Machines</i>	9
<i>Building an Appliance on a VMware System</i>	9
<i>Building an Appliance on a Hyper-V System</i>	11
<i>Installing the Database Server</i>	20
<i>Installing the Administration Portal, Data Collector and/or Message Collector</i>	24
<i>Installing VMware Tools</i>	27
<i>Installing VMware Tools Using Yum</i>	27
<i>Installing VMware Tools Manually</i>	28

Virtual Machine Specifications

For details about requirements and specifications for each ScienceLogic appliance, see the Customer Portal: <https://portal.sciencelogic.com/portal/system-requirements>.

Deploying a ScienceLogic System on Virtual Machines

To deploy a distributed ScienceLogic system on virtual machines:

1. Download the latest ISO file from the [ScienceLogic Customer Portal](#).
2. Create instances in VMWare or Hyper-V.
3. Install the ISO.
4. If you are using a VMware instance, install the VMware tools.
5. License the appliance in the Web Configuration tool.
6. Perform any additional required configuration steps.

For ease of configuration, create appliances in this order:

1. Database Server
2. Administration Portal (if applicable)
3. Data Collectors
4. Message Collectors (if applicable)

Building an Appliance on a VMware System

To deploy a ScienceLogic appliance on a VMware system:

NOTE: The Storage Node is a cluster of at least three nodes. To include a Storage Node in your SL1 configuration, build at least three identical virtual machines.

1. Download the latest ISO file from the [ScienceLogic Customer Portal](#).
2. Using the vSphere client, connect to your VMware system as a user that has permissions to deploy a new virtual machine and use the Create New Virtual Machine wizard to create a new virtual machine.

3. In the Create New Virtual Machine wizard, select the configuration options that are appropriate for your environment and the current recommended specifications for the appliance type you are installing. For details about requirements and specifications, see the Customer Portal: <https://portal.sciencelogic.com/portal/system-requirements>
4. On the **Guest Operating System** page, select *Linux* as the **Guest Operating System**, and then select *Oracle Linux 4/5/6/7 (64-bit)* in the **Version** drop-down list.

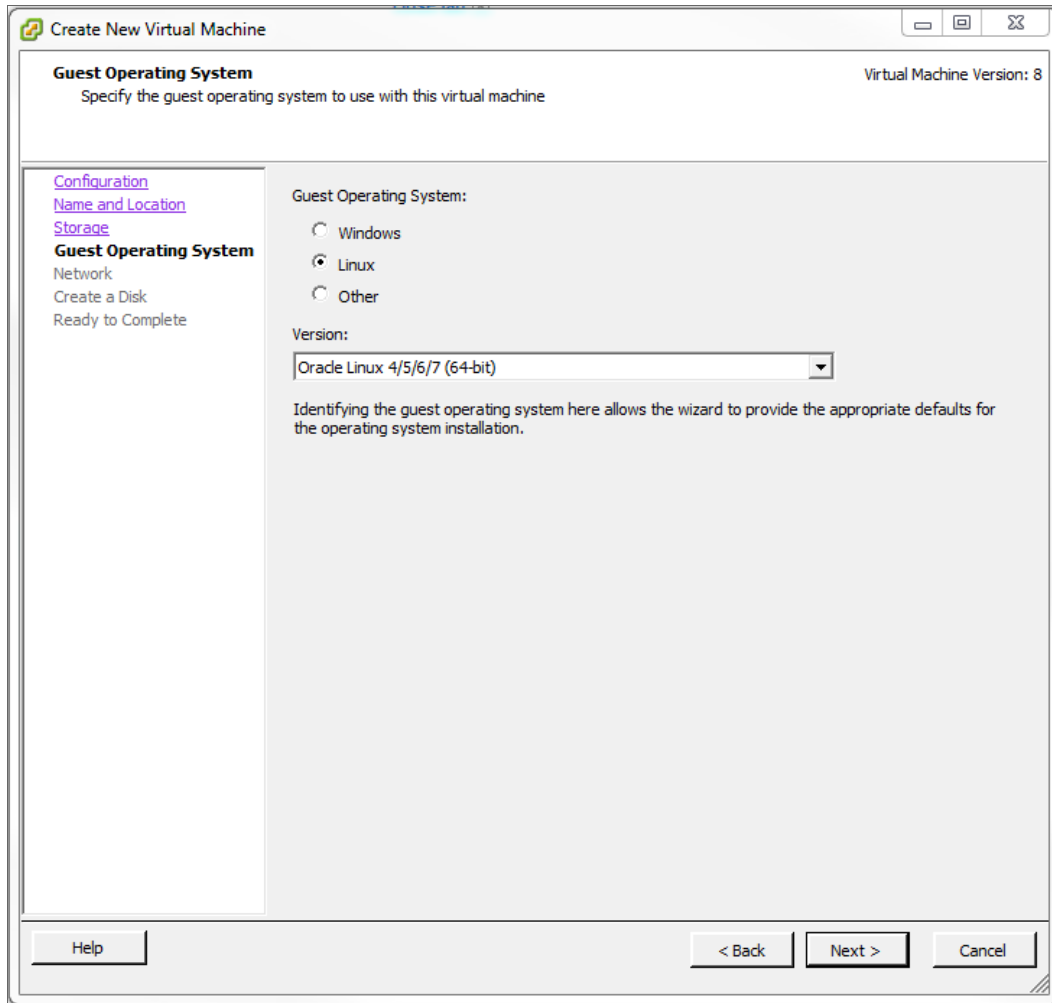

5. On the **Network** page, you must select *VMXNET 3* in the **Adapter** field.
6. After completing the Create New Virtual Machine wizard, edit the settings for the virtual machine:
 - Set the CPU and memory allocation to the recommended values you are using.
 - Configure the CD/DVD drive to use the SL1 ISO file.
7. Create the remaining virtual machines for your ScienceLogic system.

Building an Appliance on a Hyper-V System

To deploy a ScienceLogic appliance on a Hyper-V system:

NOTE: The Storage Node is a cluster of at least three nodes. To include a Storage Node in your SL1 configuration, build at least three identical virtual machines.

1. Access the Virtual Machine Manager (VMM) server via Remote Desktop Protocol (RDP).
2. Launch the Virtual Machine Manager.
3. Choose the HyperV host to deploy the Virtual Machine on and select **Create Virtual Machine**:

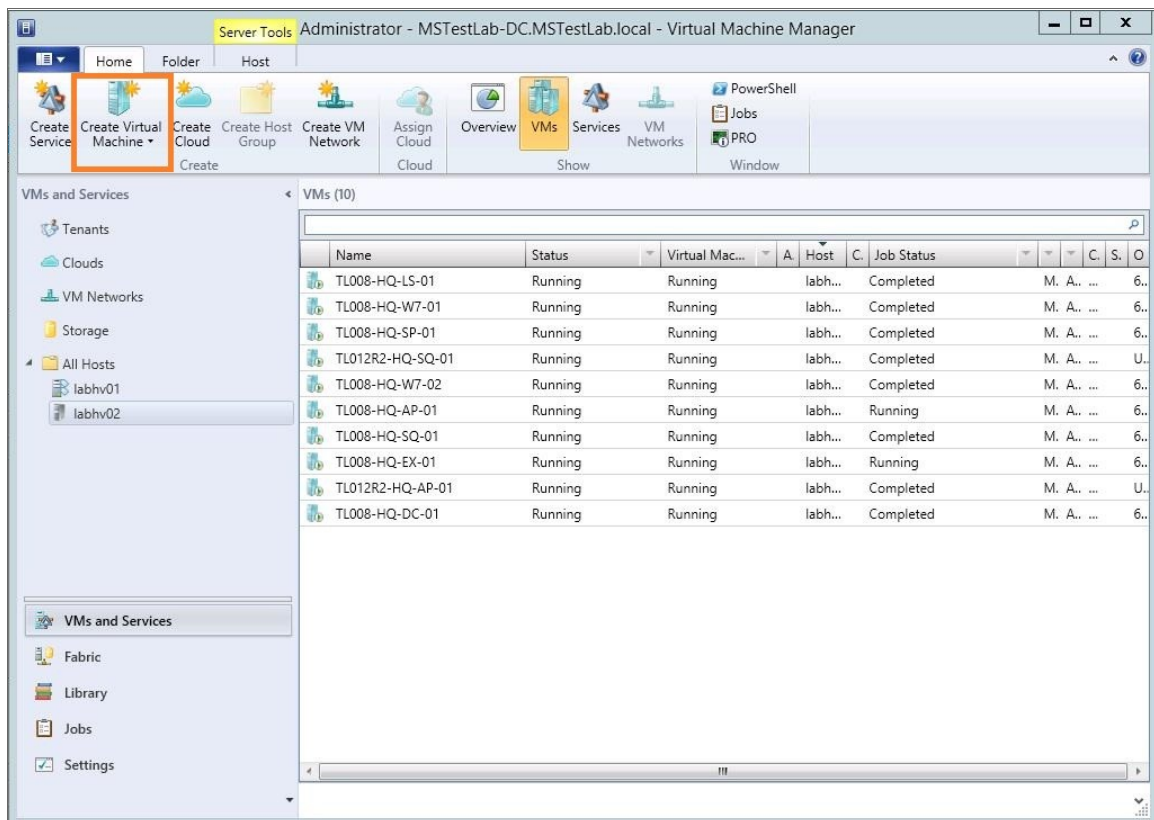

4. When the **Create Virtual Machine Wizard** appears, in the **Select Source** modal page: select *Create the new virtual machine with a blank virtual disk* and select the **[Next]** button:

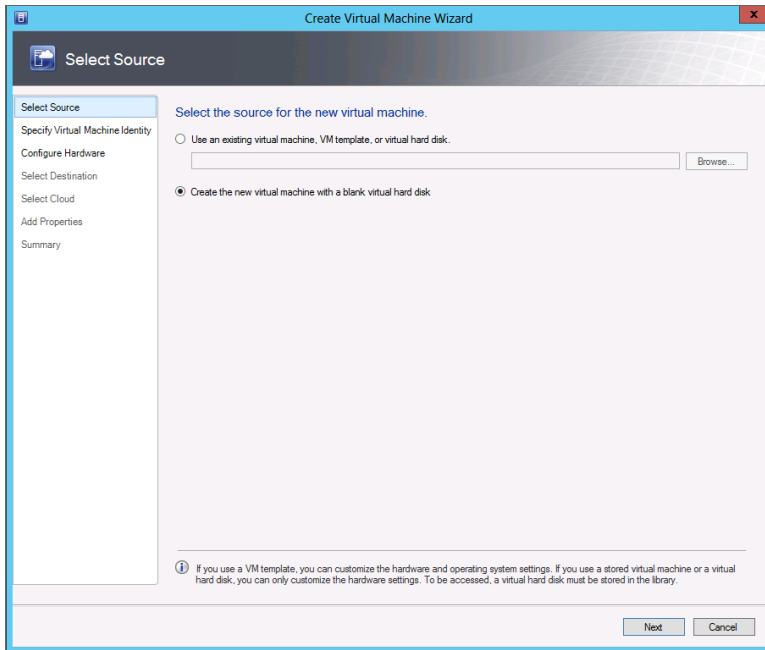

- Select *Create the new virtual machine with a blank virtual disk*.
- Select **[Next]**.

5. In the **Specify Virtual Machine Identity** page:

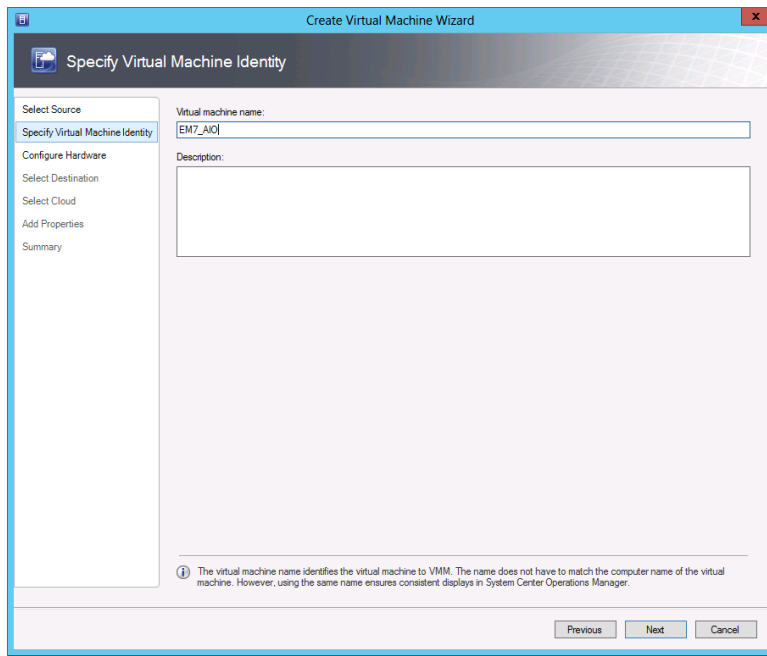

- Enter a name for the Virtual Machine in the **Virtual machine name** field and provide an optional description.
- Select **[Next]**.

6. In the **Configure Hardware** page:

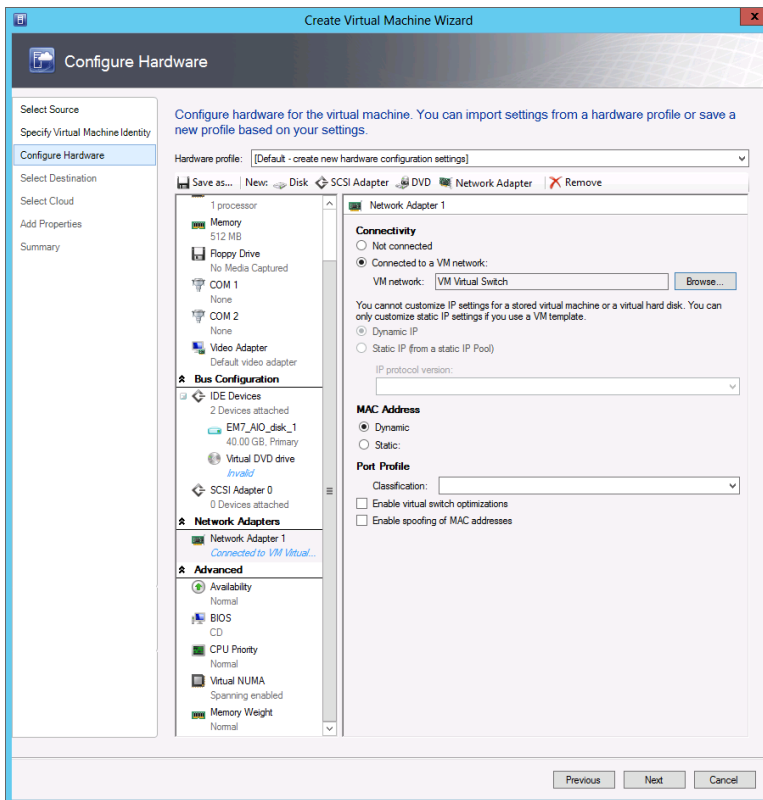

- Edit the CPU/RAM by selecting each component and modifying the values based on the [Virtual Machine requirements](#).
- Connect the network Adapter to the Virtual Switch configured for Virtual Machine traffic.

7. In the **Configure Hardware** page set the Virtual DVD to mount the installation .iso file in the datastore:

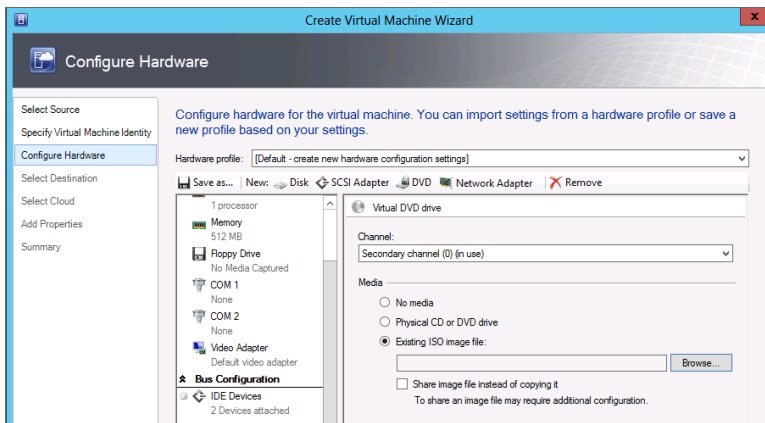

- Select *Existing ISO image file* under **Media**.
- Browse to locate the appropriate ISO file and select **[OK]** to select it.
- Select **[Next]**.

8. In the **Select Destination** page:

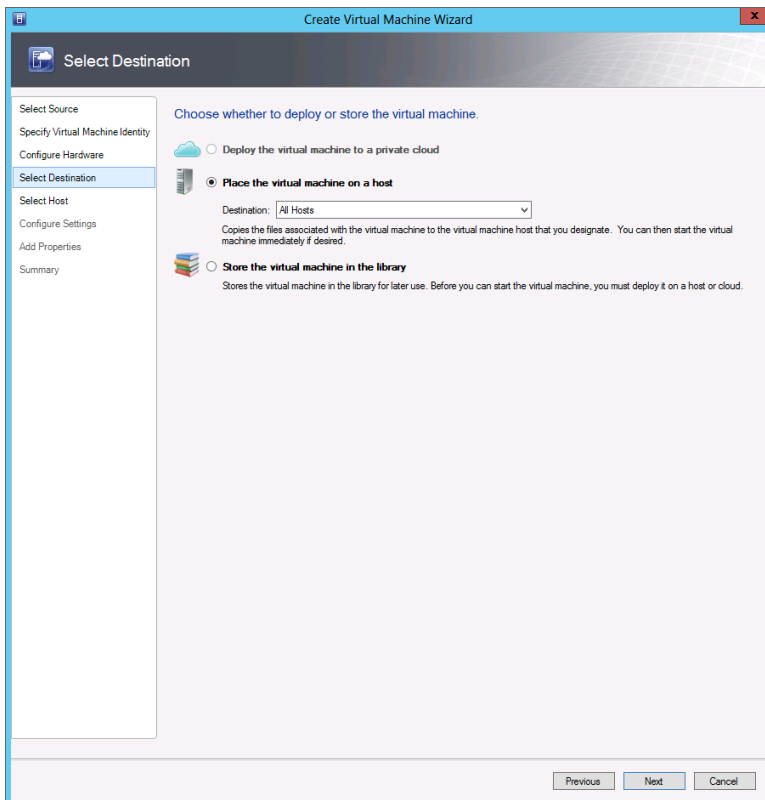

- Select the radio button for **Place the virtual machine on a host**.
- Select *All Hosts* from the drop-down menu under **Place the virtual machine on a host**.
- Select **[Next]**.

9. In the **Select Host** page:

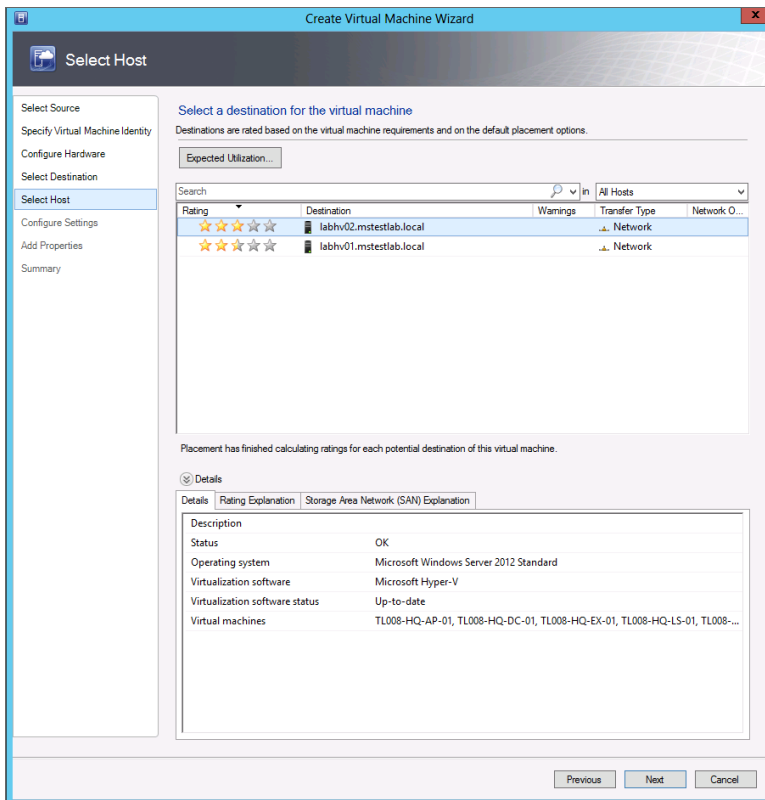

- Choose the host for the Virtual Machine
- Select **[Next]**.

10. In the **Configure Settings** page:

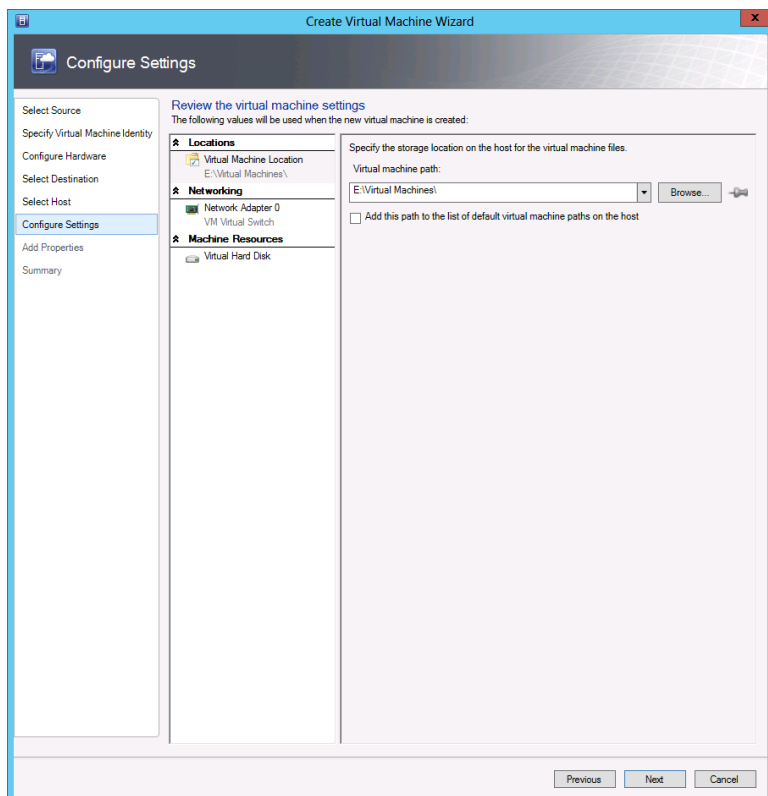

- Review the Virtual Machine settings.
- Select **[Next]**.

11. In the **Add Properties** page:

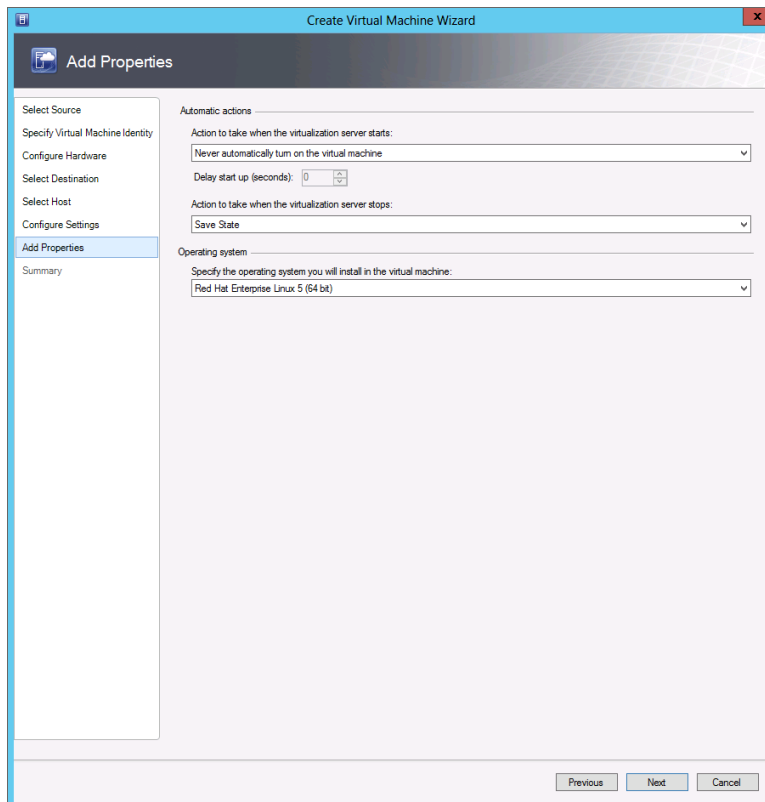

- Specify the OS type in the **Operating system** field. For the ScienceLogic platform, select *Red Hat Enterprise Linux 5 (64 bit)*.
- Select **[Next]**.

12. In the **Summary** page:

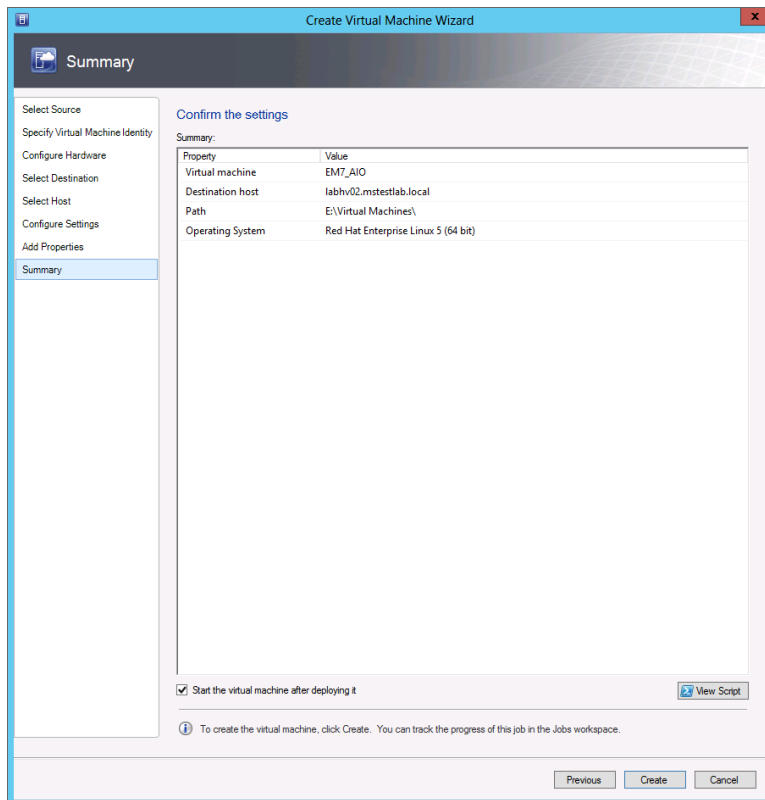

- Select the ***Start the virtual machine after deploying it*** checkbox.
- Select **[Create]**.

13. Create the remaining virtual machines for your ScienceLogic system.

Installing the Database Server

After building the virtual machines, you can install the Database Server. The Database Server should be the first appliance you install. To do so:

1. Boot the virtual machine from the SL1 ISO.

NOTE: In Hyper-V, check that the ScienceLogic installation ISO mounted correctly and that the Virtual Machine displays the install screen. To do this, right-click the Virtual Machine in inventory and select *Connect or View* and then *Connect via Console*.

2. The following window appears:



3

3. Select **Install EM7**. The **Model Type** window appears.



4. Select the *Database*. Select [Continue].
5. The Military Unique Deployment window appears. *Do not select if you ware not using a Military Unique Deployment.*



6. Select **[Continue]**. The **Database** window appears:

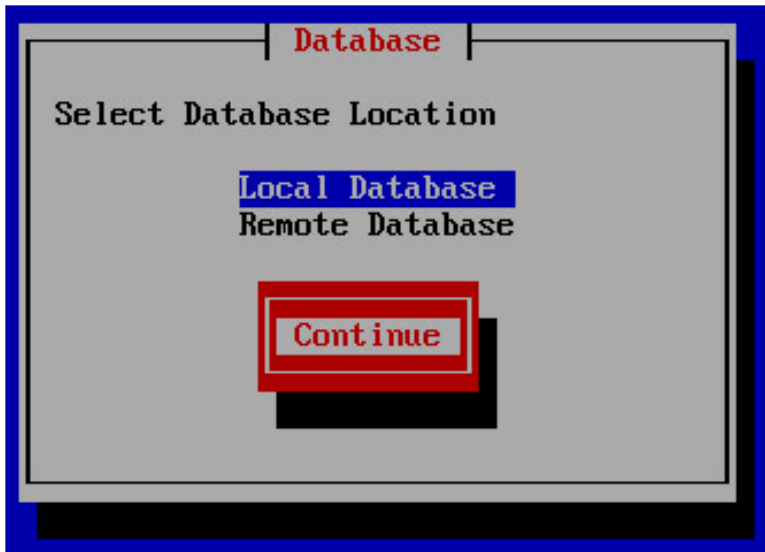

7. In the **Database** window, select *Local Database* and select **[Continue]**.
8. After the installer for the selected appliance type is loaded, the **Network Configuration** window appears.

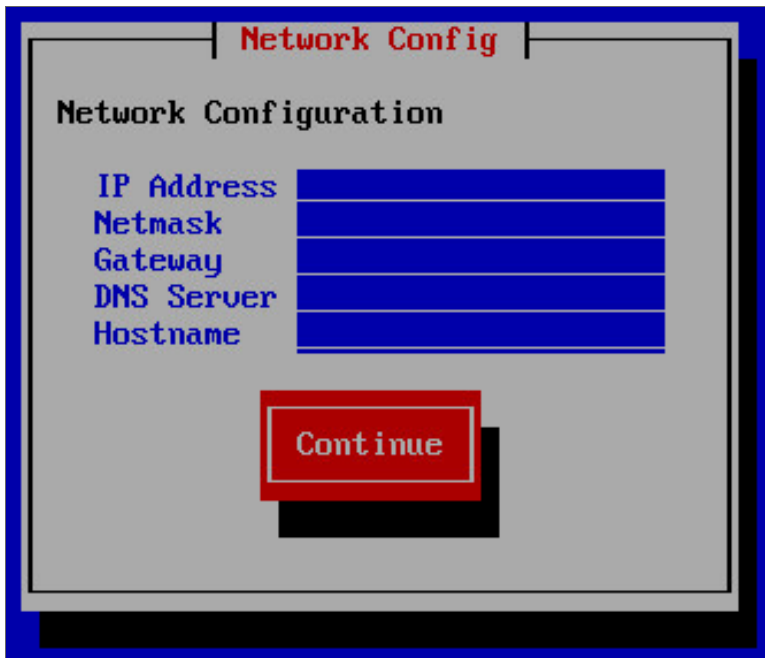

9. Enter the following information:
 - **IP Address.** Type the primary IP address of the appliance.
 - **Netmask.** Type the netmask for the primary IP address of the appliance.

- **Gateway.** Type the IP address for the network gateway.
- **DNS Server.** Type the IP address for the primary Nameserver.
- **Hostname.** Type the hostname for the appliance.

10. Select **[Continue]**.

11. The **Root Password** window appears:

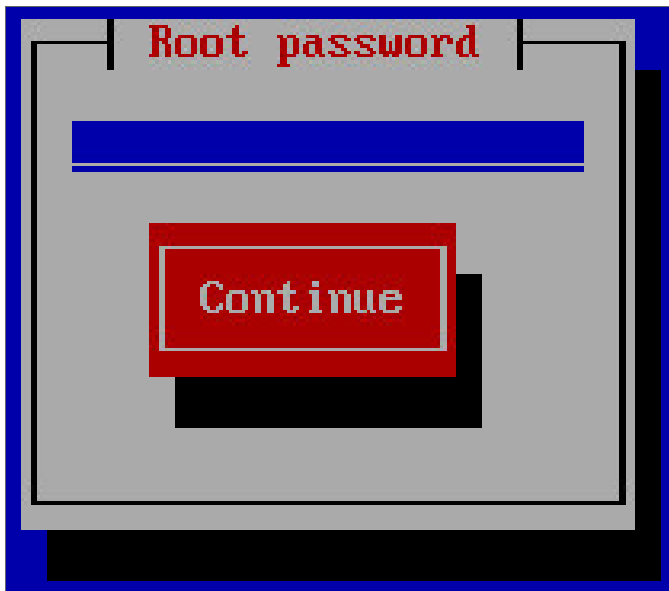

12. Type the password for the em7admin user on the operating system and select **[Continue]**.

13. Type the password for the em7admin user again and select **[Continue]**.

14. The appliance installer runs, and the virtual machine reboots automatically.

Installing the Administration Portal, Data Collector and/or Message Collector

After installing the Database Server, you can next install

1. The Administration Portal (if applicable)
2. The Data Collectors
3. The Message Collectors (if applicable)

You can use the following instructions to build the Administration Portal, and one or more Data Collectors and Message Collectors.

1. Boot the virtual machine from the SL1 ISO
2. Select *Install EM7*. The **Model Type** window appears.



3. Select the appropriate appliance type. Select **[Continue]**.
4. The Military Unique Deployment window appears. *Do not select if you ware not using a Military Unique Deployment.*



5. After the installer for the selected appliance type is loaded, the **Network Configuration** window appears.

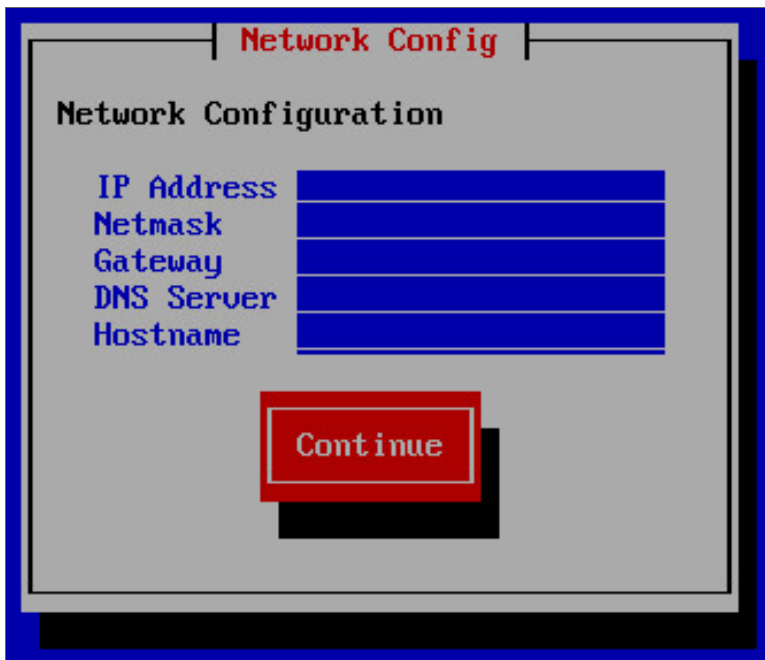

6. Enter the following information:
- **IP Address.** Type the primary IP address of the appliance.
 - **Netmask.** Type the netmask for the primary IP address of the appliance.
 - **Gateway.** Type the IP address for the network gateway.
 - **DNS Server.** Type the IP address for the primary Nameserver.
 - **Hostname.** Type the hostname for the appliance.

7. Select **[Continue]**.
8. The **Root Password** window appears:

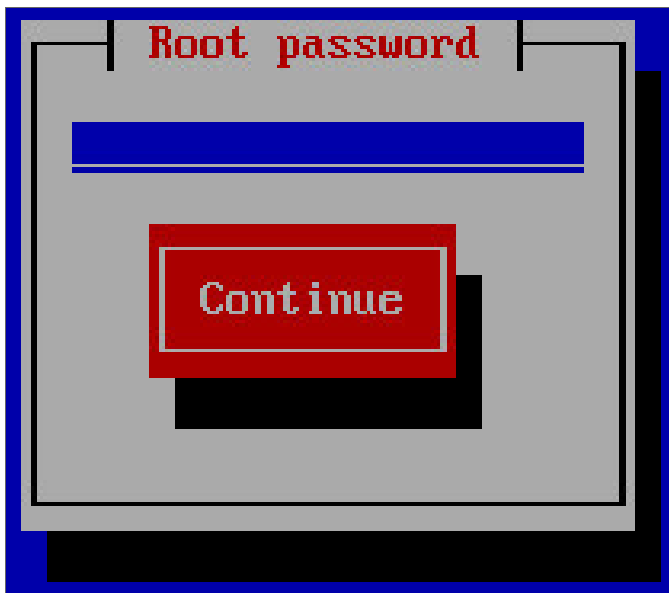

9. Type the password for the em7admin user on the operating system and select **[Continue]**.
10. Type the password for the em7admin user again and select **[Continue]**.

Installing VMware Tools

You can install VMware tools in two ways:

- If your appliance can connect to the Internet, use the yum utility to install the necessary packages.
- If your appliance cannot connect to the Internet, install the RPM files manually. Contact ScienceLogic to get the necessary RPM files to perform the installation.

Installing VMware Tools Using Yum

To install VMware tools using the yum utility:

1. Log in to the appliance as the em7admin user using the console or SSH.
2. Execute the following command:

```
sudo yum install open-vm-tools
```
3. Type the password for the em7admin user when prompted.
4. When prompted to confirm the installation, type "y".

5. Execute the following commands:

```
sudo systemctl start vmtoolsd.service
sudo systemctl enable vmtoolsd.service
sudo systemctl status vmtoolsd.service
```

If the installation was successful, the "Active" line in the output indicates VMware tools is "active (running)".

Installing VMware Tools Manually

To install VMware tools manually:

1. Contact ScienceLogic to get the necessary RPM files to perform the installation.
2. Copy the provided .tgz file to the /home/em7admin directory on the appliance.
3. Log in to the appliance as the em7admin user using the console or SSH.
4. Execute the following command, typing the name of the provided file where indicated:

```
tar zxvf [name of provided tgz file]
```

5. Execute the following command:

```
ls
```

6. Note the full file names of the following packages:

- libmspack
- libdnet
- fuse
- fuse-libs
- open-vm-tools

7. Execute the following command for each file listed in step 6, in the order in which they are listed. Type the password for the em7admin user when prompted:

```
sudo rpm -ivh [full file name]
```

8. Execute the following commands:

```
sudo systemctl start vmtoolsd.service
sudo systemctl enable vmtoolsd.service
sudo systemctl status vmtoolsd.service
```

If the installation was successful, the "Active" line in the output indicates VMware tools is "active (running)".

Licensing and Configuring an Appliance

Overview

This chapter describes how to license a ScienceLogic appliance and add it to your ScienceLogic system.

This chapter describes:

<i>Logging in to the Web Configuration Utility</i>	30
<i>Changing the Password for the Web Configuration Utility</i>	31
<i>Licensing and Configuring a Database Server or All-In-One Appliance</i>	32
<i>Configuring an Administration Portal</i>	33
<i>Configuring a Data Collector or Message Collector</i>	34
<i>Register the Data Collector or Message Collector with the Database Server</i>	35
<i>Defining the Syslog Server</i>	38
<i>Defining the NTP Server</i>	39
<i>Creating a Bonded Interface</i>	40
<i>Defining a Proxy Server</i>	43

ScienceLogic appliances automatically generate a Registration Key file. This file is used by ScienceLogic to generate a unique License Key file. **You must not edit or alter the Registration Key file.** While performing the steps described in this chapter, you must obtain a License Key file by providing the Registration Key file to ScienceLogic.

For distributed ScienceLogic systems, you must license the Database Server first. All other ScienceLogic appliances in a distributed ScienceLogic system depend on the Database Server for registration.

Logging in to the Web Configuration Utility

Perform the following steps to log in to the Web Configuration Utility:

1. You can log in to the Web Configuration Utility using any web browser supported by the platform. The address of the Web Configuration Utility is in the following format:

`https://ip-address-of-appliance:7700`

NOTE: For AWS instances, *ip-address-of-appliance* is the public IP for the AWS instance. To locate the public IP address for an AWS instance, go to AWS, go to the **Instances** page, and highlight an instance. The **Description** tab in the lower pane will display the public IP.

3. When prompted to enter your user name and password, log in as the "em7admin" user with either the default password of **em7admin** or the password you configured.

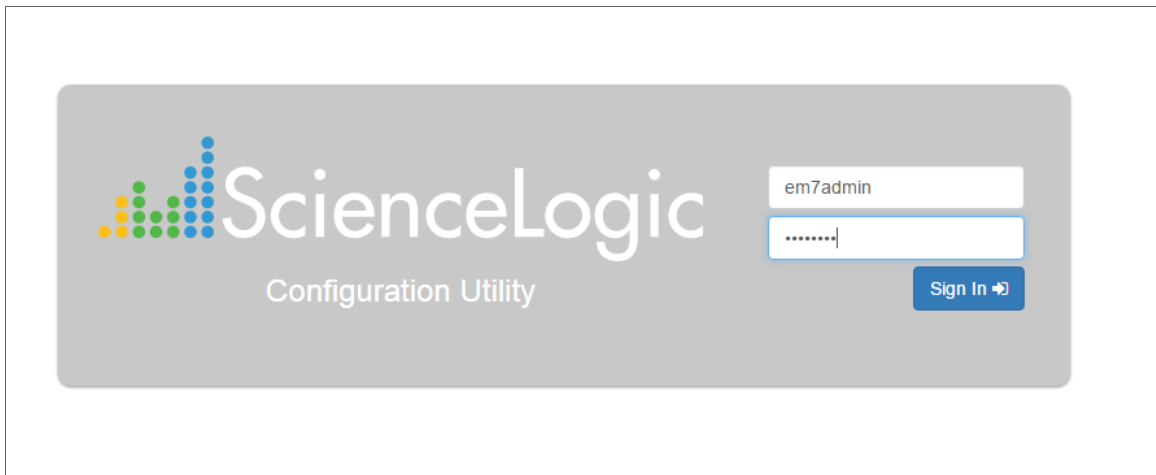

4. After logging in, the main **Configuration Utility** page appears:

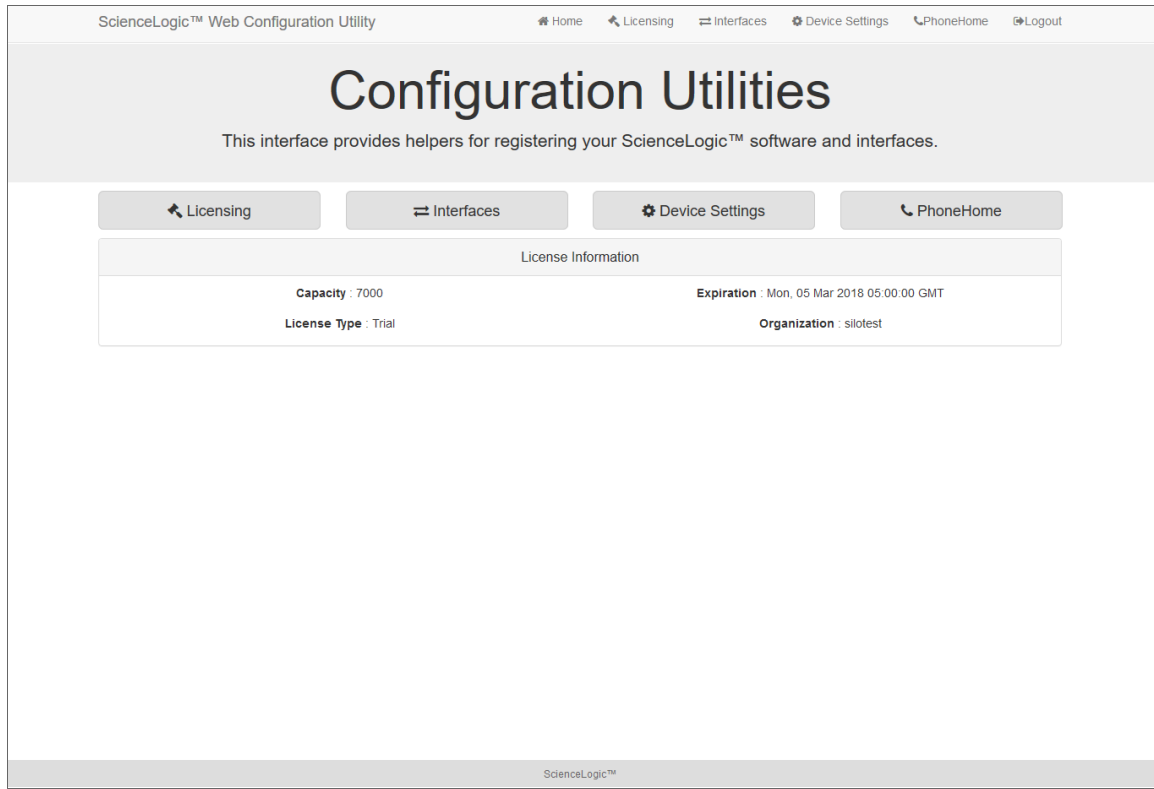

5. The next configuration steps are different for different types of ScienceLogic appliances. Refer to the appropriate section for the type of ScienceLogic appliance you are configuring.

Changing the Password for the Web Configuration Utility

You can change the password for the Web Configuration Utility.

NOTE: If you want to change the password for the Web Configuration Utility on all ScienceLogic appliances, you must log in to the Web Configuration Utility on each appliance and perform the steps in this section.

NOTE: You cannot change the username for the Web Configuration Utility. The username remains **em7admin**.

To change the password for the Web Configuration Utility:

1. Log in to the Web Configuration Utility. The **Configuration Utilities** page appears.

2. Click the **[Device Settings]** button. The **Settings** page appears.

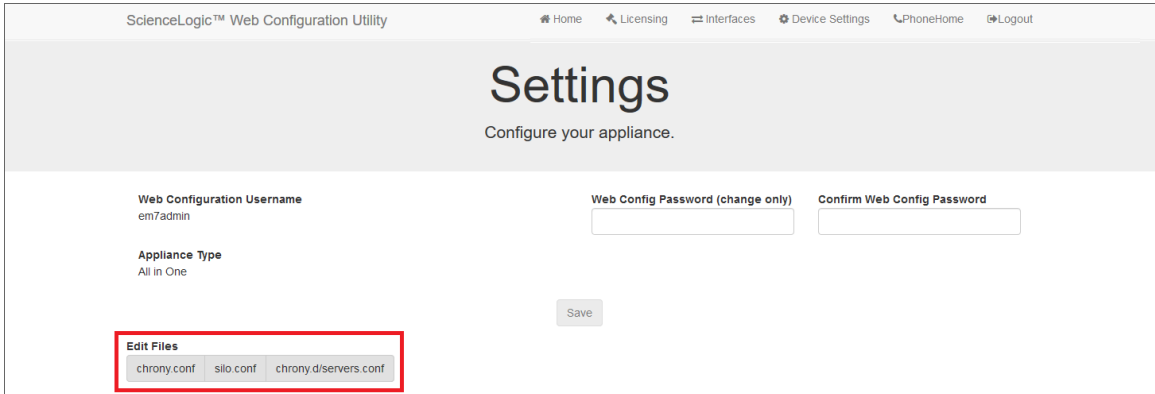

ScienceLogic™ Web Configuration Utility

Home Licensing Interfaces Device Settings PhoneHome Logout

Settings

Configure your appliance.

Web Configuration Username
em7admin

Web Config Password (change only)

Confirm Web Config Password

Appliance Type
All In One

Save

Edit Files

chrony.conf silo.conf chrony.d/servers.conf

3. In the **Settings** page, type the following:
 - **Web Config Password (change only)**. Type the new password.
 - **Confirm Web Config Password**. Type the new password again.
4. Click **[Save]**
5. Perform steps 1-4 for each appliance for which you want to change the password for the Web Configuration Utility.

Licensing and Configuring a Database Server or All-In-One Appliance

You must perform the following steps in the Web Configuration Utility to license an All-In-One Appliance or Database Server:

1. [Log in to the Web Configuration Utility](#). The **Configuration Utilities** page appears.
2. Click the **[Licensing]** button. The **Licensing Step 1** page appears.

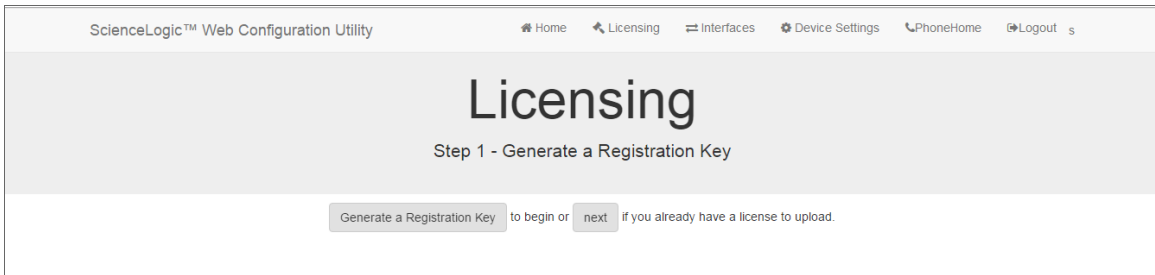

ScienceLogic™ Web Configuration Utility

Home Licensing Interfaces Device Settings PhoneHome Logout

Licensing

Step 1 - Generate a Registration Key

Generate a Registration Key to begin or next if you already have a license to upload.

3. In the Licensing Step 1 page, click the **[Generate a Registration Key]** button.
4. When prompted, save the Registration Key file to your local disk.

5. Log in to the ScienceLogic Customer Portal (<https://portal.sciencelogic.com>). Click the **License Request** tab and follow the instructions for requesting a license key. ScienceLogic will provide you with a License Key file that corresponds to the Registration Key file.
6. Return to the Web Configuration Utility.

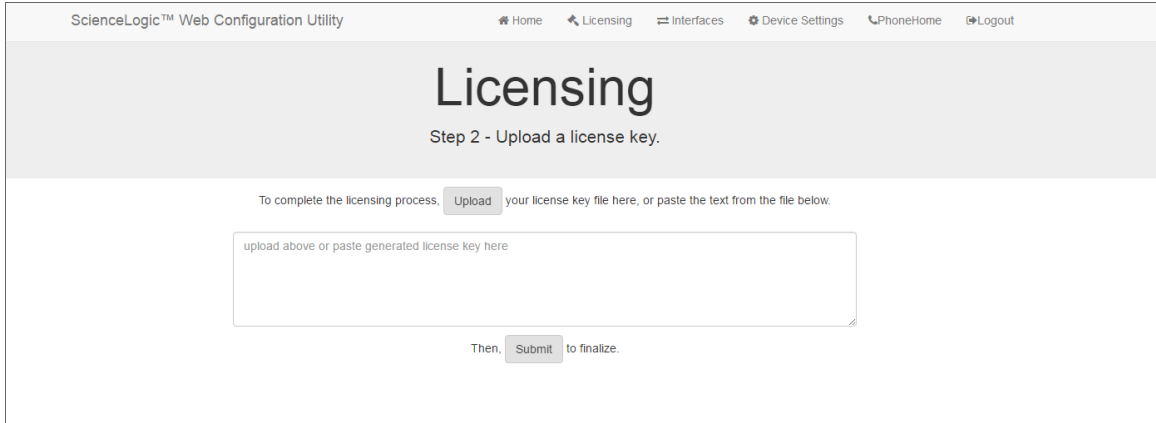

7. In the **Licensing Step 2** page, click the **[Upload]** button to upload the license file.
8. After navigating to and selecting the license file, click the **[Submit]** button to finalize the license. If the license key is correct and has been saved successfully, the message "Success: Thank you for licensing your ScienceLogic product!" appears.

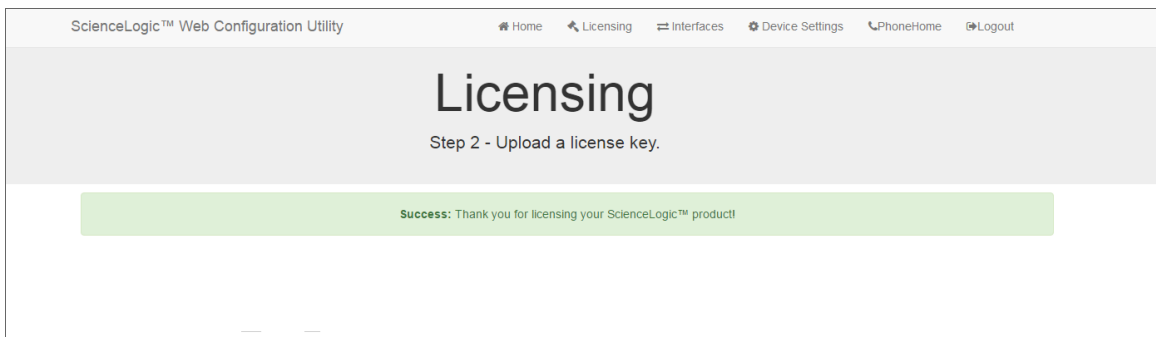

Configuring an Administration Portal

You must perform the following steps in the Web Configuration Utility to configure an Administration Portal:

1. [Log in to the Web Configuration Utility](#). The **Configuration Utilities** page appears.
2. Click the **[Device Settings]** button in the upper-right of the page. The **Settings** page appears.

3. In the **Settings** page, enter the following:

- **Database IP Address.** The IP address of the primary ScienceLogic Database Server. If the Administration Portal and Database Server are AWS instances, supply the private IP address for the Database Server. To find the private IP of an AWS instance, go to AWS, go to the **Instances** page, and highlight an instance. The **Description** tab in the lower pane will display the private IP.
- **Database Username.** Username for the database account that the Administration Portal will use to communicate with the Database Server.
- **Accept the default values in all other fields.**

4. Click the **[Save]** button. You may now log out of the Web Configuration Utility.

Configuring a Data Collector or Message Collector

NOTE: If your ScienceLogic system is built from the 8.1.1 . ISO or earlier, you will have to license each Data Collector and Message Collector. For ScienceLogic systems running versions later than 8.1.1 , Data Collectors and Message Collectors do not require a license. For details on licensing Data Collectors and Message Collectors, see the **Licensing an Appliance** chapter in the 7.8 version of this manual.

NOTE: The instructions for configuring a Data Collector or Message Collector for PhoneHome configuration differ from the instructions in this section. For details on configuring a Data Collector or Message Collector for PhoneHome configuration, see the chapter on [PhoneHome](#).

You must perform the following steps in the Web Configuration Utility to configure a Data Collector or a Message Collector:

1. [Log in to the Web Configuration Utility](#) on the Data Collector or the Message Collector. The **Configuration Utilities** page appears.
2. Click the **[Device Settings]** button. The **Settings** page appears.

ScienceLogic™ Web Configuration Utility

Home Licensing Interfaces Device Settings PhoneHome Logout

Settings

Configure your appliance.

Web Configuration Username
em7admin

Web Config Password (change only)

Confirm Web Config Password

Appliance Type
Collection Unit

Database IP Address(s) - comma separated, no spaces
10.2.3.16

Save

Edit Files

chrony.conf silo.conf chrony.d/servers.conf

3. In the **Settings** page, update the following field:
 - **Database IP Address.** The IP address of the ScienceLogic Database Server(s). If more than one Database Server will manage this appliance, type the IP addresses of the Database Servers, separated by commas. If the Data Collector or the Message Collector and the Database Server are AWS instances, supply the private IP address for the Database Server. To find the private IP of an AWS instance, go to AWS, go to the **Instances** page, and highlight an instance. The **Description** tab in the lower pane will display the private IP.
4. Click the **[Save]** button. You may now log out of the Web Configuration Utility.
5. Perform these steps for each Data Collector and Message Collector in your PhoneHome configuration.

Register the Data Collector or Message Collector with the Database Server

After configuring a Data Collector or Message Collector in the Web Configuration Utility, you must register the appliance with the main Database Server in your ScienceLogic system.

To register a Data Collector or Message Collector with the main Database Server, perform the following steps:

1. In the address bar of your browser, type the IP address of the ScienceLogic appliance that provides the user interface for your ScienceLogic system. The user interface is provided by either the Database Server or an Administration Portal. The login screen appears:



2. Log in as the "em7admin" user with the password "em7admin".
3. If this is your first successful login, you will be asked to agree to the End-user License Agreement. Read the End-user License Agreement then click the **[I Agree to The Terms Outlined Above]** button.

- Go to the **Appliance Manager** page (System > Settings > Appliances):

The screenshot displays the ScienceLogic Appliance Manager interface. At the top, there is a navigation bar with options like Home, Dashboards, Views, Events, Tickets, Knowledge, Reports, Registry, System, and References. The main content area is titled 'Appliance Manager' and contains a configuration form with the following fields:

- Host Name (text input)
- IP Address (text input)
- Model type (dropdown menu)
- Description (text input)

Buttons for 'Save' and 'Save As' are located to the right of the form. Below the form is a table listing existing appliances:

	Name	IP Address	Module Type	Collector Group	Description	Build	Capacity	Allocation	ID	Validated	Edit Date	Edit User	Create
1.	10-64-170-100-ISO-CDB	10.64.170.100	Database	n/a	Database: 10.64.170.100	8.7.0 #592	7,000	n/a	1	Yes	2017-12-05 16:34:05	em7admin	2017-12-05 16:34:05
2.	10-64-170-101-ISO-AP	10.64.170.101	Administration Portal	n/a	Application Server: 10.64.170.101	8.7.0 #592	n/a	n/a	2	Yes	2017-12-05 16:34:12	em7admin	2017-12-05 16:34:12
3.	10-64-170-102-ISO-CU-RebelScrum	10.64.170.102	Data Collection Unit	CUG-RebelScrum	collector unit: 10.64.170.102	8.7.0 #592	n/a	0	3	Yes	2017-12-05 16:39:39	em7admin	2017-12-05 16:39:39
4.	10-64-170-103-ISO-CU-Knights	10.64.170.103	Data Collection Unit	CUG-Knights	collector unit: 10.64.170.103	8.7.0 #592	n/a	0	4	Yes	2017-12-05 16:39:37	em7admin	2017-12-05 16:39:37
5.	10-64-170-104-ISO-CU-Starford	10.64.170.104	Data Collection Unit	CUG-Starford	collector unit: 10.64.170.104	8.7.0 #592	n/a	0	5	Yes	2017-12-05 16:39:39	em7admin	2017-12-05 16:39:39
6.	10-64-170-105-ISO-CU-RNGs	10.64.170.105	Data Collection Unit	CUG-RNGs	collector unit: 10.64.170.105	8.7.0 #592	n/a	0	6	Yes	2017-12-05 16:39:38	em7admin	2017-12-05 16:39:38
7.	10-64-170-106-ISO-CU-MN	10.64.170.106	Data Collection Unit	CUG-MN	collector unit: 10.64.170.106	8.7.0 #592	n/a	0	7	Yes	2017-12-05 16:39:37	em7admin	2017-12-05 16:39:37
8.	10-64-170-107-ISO-CU-MOSS	10.64.170.107	Data Collection Unit	CUG-MOSS	collector unit: 10.64.170.107	8.7.0 #592	n/a	0	8	Yes	2017-12-05 16:39:39	em7admin	2017-12-05 16:39:39
9.	10-64-170-108-ISO-CU-UsualSuspects1	10.64.170.108	Data Collection Unit	CUG-UsualSuspects	collector unit: 10.64.170.108	8.7.0 #592	n/a	0	9	Yes	2017-12-05 16:39:36	em7admin	2017-12-05 16:39:36
10.	10-64-170-109-ISO-CU-UsualSuspects2	10.64.170.109	Data Collection Unit	CUG-UsualSuspects	collector unit: 10.64.170.109	8.7.0 #592	n/a	0	10	Yes	2017-12-05 16:42:06	em7admin	2017-12-05 16:42:06
11.	10-64-170-110-ISO-CU-SAC	10.64.170.110	Data Collection Unit	CUG-SAC	collector unit: 10.64.170.110	8.7.0 #592	n/a	0	11	Yes	2017-12-05 16:42:06	em7admin	2017-12-05 16:42:06
12.	10-64-170-111-ISO-CU-Boaty	10.64.170.111	Data Collection Unit	CUG-Boaty	collector unit: 10.64.170.111	8.7.0 #592	n/a	0	12	Yes	2017-12-05 16:41:05	em7admin	2017-12-05 16:41:05
13.	10-64-170-112-ISO-MC	10.64.170.112	Message Collection Unit	--	collector unit: 10.64.170.112	8.7.0 #592	n/a	n/a	13	Yes	2017-12-05 16:39:40	em7admin	2017-12-05 16:39:40

- Supply values in the following fields:

- Host Name.** Enter the hostname of the Data Collector or Message Collector.
- IP Address.** Enter the IP address of the Data Collector or Message Collector. If the Data Collector or the Message Collector are AWS instances, supply the private IP address for the Data Collector or the Message Collector. To find the private IP of an AWS instance, go to AWS, go to the **Instances** page, and highlight an instance. The **Description** tab in the lower pane will display the private IP.
- Model Type.** If you are configuring a Data Collector, select *Data Collection Unit [5]* from the drop-down list. If you are configuring a Message Collector, select *Message Collection Unit [6]* from the drop-down list.
- Description.** Enter a description for the Data Collector or Message Collector. This field is optional.

- Click the **[Save]** button. If the save is successful, the message "Appliance Registered" appears.
- If all information is valid and the Database Server can communicate with the Data Collector or Message Collector, the appliance page will display "Yes" in the **Validated** column. If the **Validated** column displays "No" for longer than five minutes, double-check your settings and network connection.

Defining the Syslog Server

For each device except for Message Collectors and All-In-One Appliances, you must specify the IP address of the server to which the ScienceLogic appliance will send syslog messages. Enter the IP address of the syslog server that will monitor this ScienceLogic appliance. Usually, this is the IP address of a Message Collector, Data Collector, or All-In-One Appliance.

NOTE: A device configured with Transport Layer Security (TLS) support for an rsyslog server can successfully exchange messages with a ScienceLogic appliance configured with TLS support for an rsyslog client.

To specify the syslog server:

1. Either go to the console of the ScienceLogic appliance or use SSH to access the server.
2. Log in as user **em7admin** with the password you configured during setup.
3. Install the required Transport Layer Security (TLS) certificates by typing the following lines at the shell prompt:

```
mkdir -pv /etc/rsyslog.d/keys/ca.d
cd /etc/rsyslog.d/keys/ca.d/
```

NOTE: You might need to create a **ca.d** directory to contain the certificates needed for TLS encryption.

4. To define the syslog server, type the following at the shell prompt:

```
sudo vi /etc/rsyslog.d/siteconfig.conf
```

5. On a line of its own, add the following entry:

```
facility.priority@ip address of syslog server
```

where:

- *facility* specifies a valid facility value. These categories provide a general description of the originator of the message.
- *priority* specifies a valid priority value. These values specify severity.
- *ip address of syslog server* specifies the IP address of the syslog server that will monitor this ScienceLogic appliance, usually a Data Collector or Message Collector.

NOTE: For details on valid facility and priority values, see https://docs.oracle.com/cd/E37670_01/E36387/html/ol_log_sec.html.

6. Save your changes and exit the file (:wq).
7. At the command line, type the following:

```
sudo service rsyslog restart
```

8. Repeat steps 1-7 on each ScienceLogic appliance in your system.

Defining the NTP Server

By default, the ScienceLogic platform uses the time servers in the Red Hat Linux pool of time servers. If you want to use a different time server, you can edit the configuration files for the time server.

From the **Device Settings** page of the Web Configuration Utility, you can edit the following time server files:

- **chrony.d/servers.conf**. This configuration file contains additional settings for the various chrony time servers.
- **chrony.conf**. This configuration file contains settings related to the time server (chrony.d) used by the ScienceLogic platform.

To configure a time server file:

1. [Log in to the Web Configuration Utility](#). The **Configuration Utilities** page appears.
2. Click the **[Device Settings]** button. The **Settings** page appears.

ScienceLogic™ Web Configuration Utility

Home Licensing Interfaces Device Settings PhoneHome Logout

Settings

Configure your appliance.

Web Configuration Username: em7admin

Web Config Password (change only):

Confirm Web Config Password:

Appliance Type: All in One

Save

Edit Files

chrony.conf silo.conf chrony.d/servers.conf

3. In the Edit Files section, click **chrony.d/servers.conf**. The Chrony.d/servers.conf Editor modal page appears:

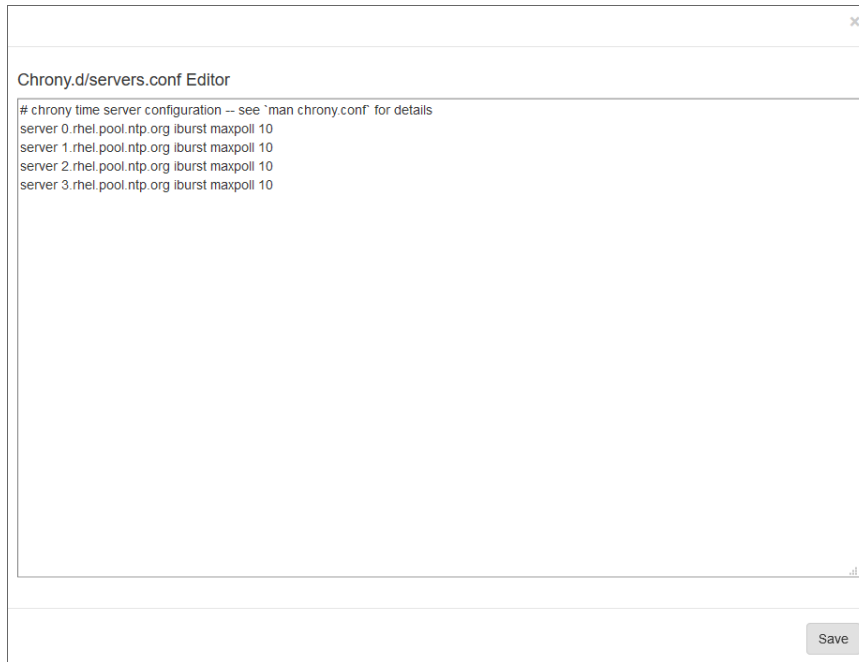

4. In the Chrony.d/servers.conf modal page, copy the first line that begins with **server**, such as **server 0.rhel.pool.ntp.org iburst maxpoll 10**.
5. Paste that line *above* the first line that begins with **server**.
6. Replace the hostname portion of the line with the IP address or fully qualified domain name of your preferred time server.
7. You can delete the additional lines or leave them as additional time servers.
8. To save your changes, click **Save** and then close the modal window.
9. If you need to configure the time server (chrony.d) used by the ScienceLogic platform, click **chrony.conf** in the Edit Files section of the Settings page.

Creating a Bonded Interface

A bonded interface (also known as port trunking, channel bonding, link aggregation, and NIC teaming) allows you to combine multiple network interfaces (called "slave interfaces") into a single logical interface (called a "master interface"). A bonded interface can:

- increase available bandwidth
- provide redundancy

To the operating system, a bonded interface appears as a normal network interface. However, the bonded interface uses a round-robin protocol to assign network traffic to the slave interfaces that make up the bonded interface.

To create one or more bonded interfaces:

1. [Log in to the Web Configuration Utility](#). The **Configuration Utilities** page appears.
2. Click the **[Interfaces]** button. The **Interfaces** page appears.

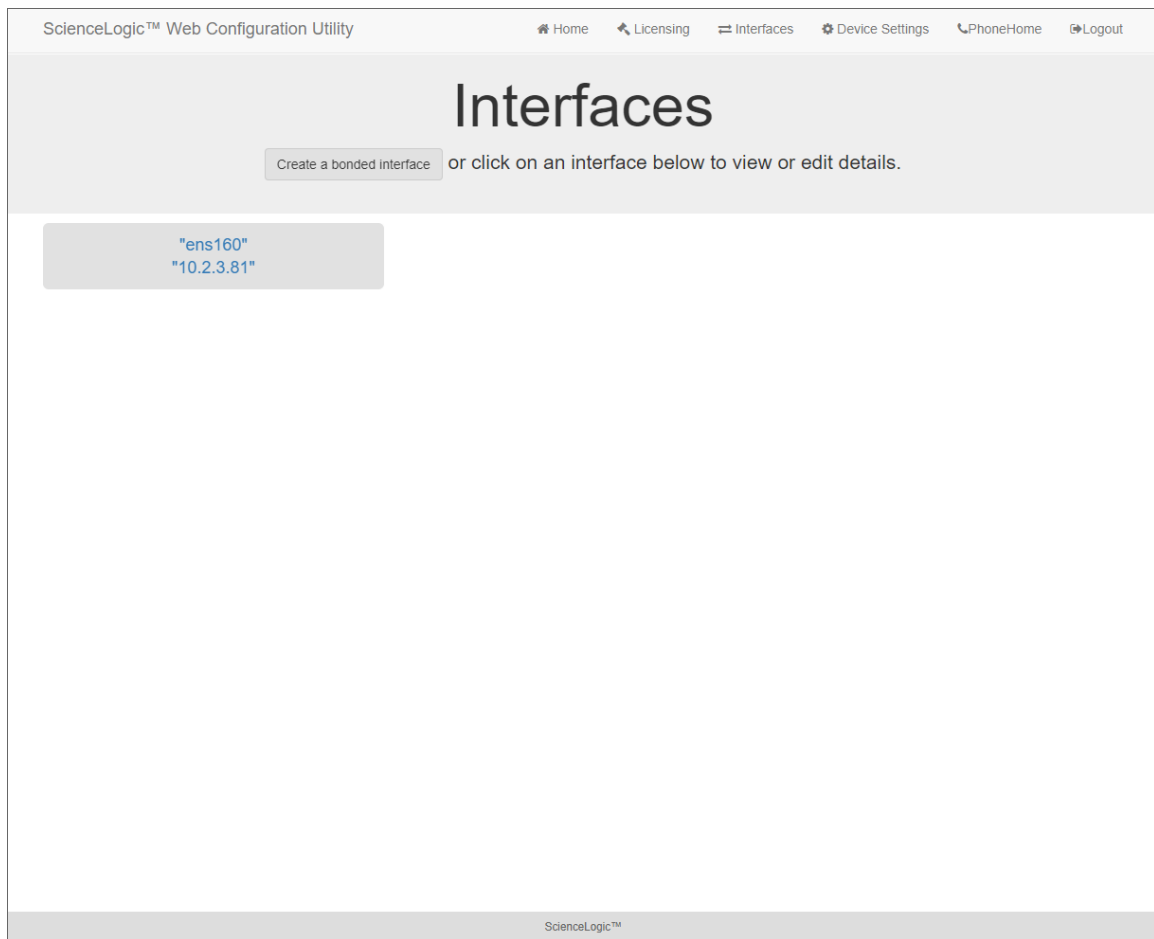

3. In the **Interfaces** page, click the **[Create a bonded interface]** button. The **Create a Bonded Interface** page appears.

ScienceLogic™ Web Configuration Utility

Home Licensing Interfaces Device Settings PhoneHome Logout

Create a Bonded Interface

Activate

Name

Netmask IP Address

Gateway IP Address

Slave Interfaces (select at least 1)

Device ID

Interface IP Address

DNS 1 (optional)

IPv6 Address (optional)

Bonding Options

key value

+ Add another option

Save

Non-editable properties

ScienceLogic™

4. In the **Create a Bonded Interface** page, enter the following:

- **Device ID**. Required. ID for the bonded interface. Enter a string with the format:

`bondN`

where *N* is a number. For example, you could enter ***bond0***, ***bond1***, or ***bond64***.

If the device ID already exists in the ScienceLogic system, the ScienceLogic system will display an error message.

- **Name**. Required. Enter a user name for the bonded interface.
- **Interface IP Address**. Required. Enter the IP address for the bonded interface in standard IPv4, dotted-octet format.

- **Netmask IP Address.** Required. Enter the netmask for the bonded interface in standard IPv4, dotted-octet format.
- **Slave Interfaces.** Required. Select one or more interfaces from the list of available interfaces. The selected interfaces will be used by the new bonded interface.
- **DNS1.** Optional. Enter the IP address of the DNS server that the bonded interface will use. Enter the IP address in standard IPv4, dotted-octet format.
- **Gateway IP Address.** Optional. Enter the IP address of the gateway device or router that the bonded interface will use. Enter the IP address in standard IPv4, dotted-octet format.
- **IPv6 Address.** Optional. Enter the IP address for the bonded interface, in IPv6 format.
- **Bonding Options.** Optional. You can enter one or more bonding options. For each option, enter the name of the option in the *key* field and the value in the *value* field.

For details on bonding options, see the Red Hat documentation on Bonding Interface Parameters: https://access.redhat.com/documentation/en-US/Red_Hat_Enterprise_Linux/6/html/Deployment_Guide/sec-Specific_Kernel_Module_Capabilities.html#s3-modules-bonding-directives

Defining a Proxy Server

A proxy server enables ScienceLogic appliances to get system updates when the appliance does not have a direct connection to the internet. A proxy server also enables ScienceLogic Database Servers to send subscription licensing data to ScienceLogic.

Each ScienceLogic appliance can define its own proxy server.

To define a proxy server:

1. Go to the **Appliance Manager** page (System > Settings > Appliances).
2. Find the appliance for which you want to define a proxy server. Click its toolbox icon ()
3. When prompted to enter your username and password, log in as the "em7admin" user with either the default password of **em7admin** or the password you configured.

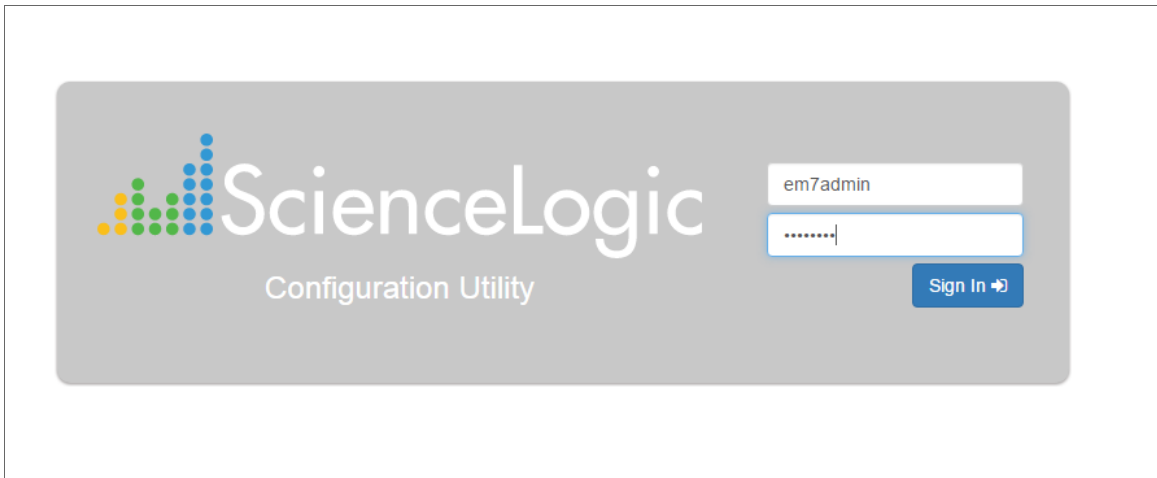

4. After logging in, the main **Configuration Utility** page appears:

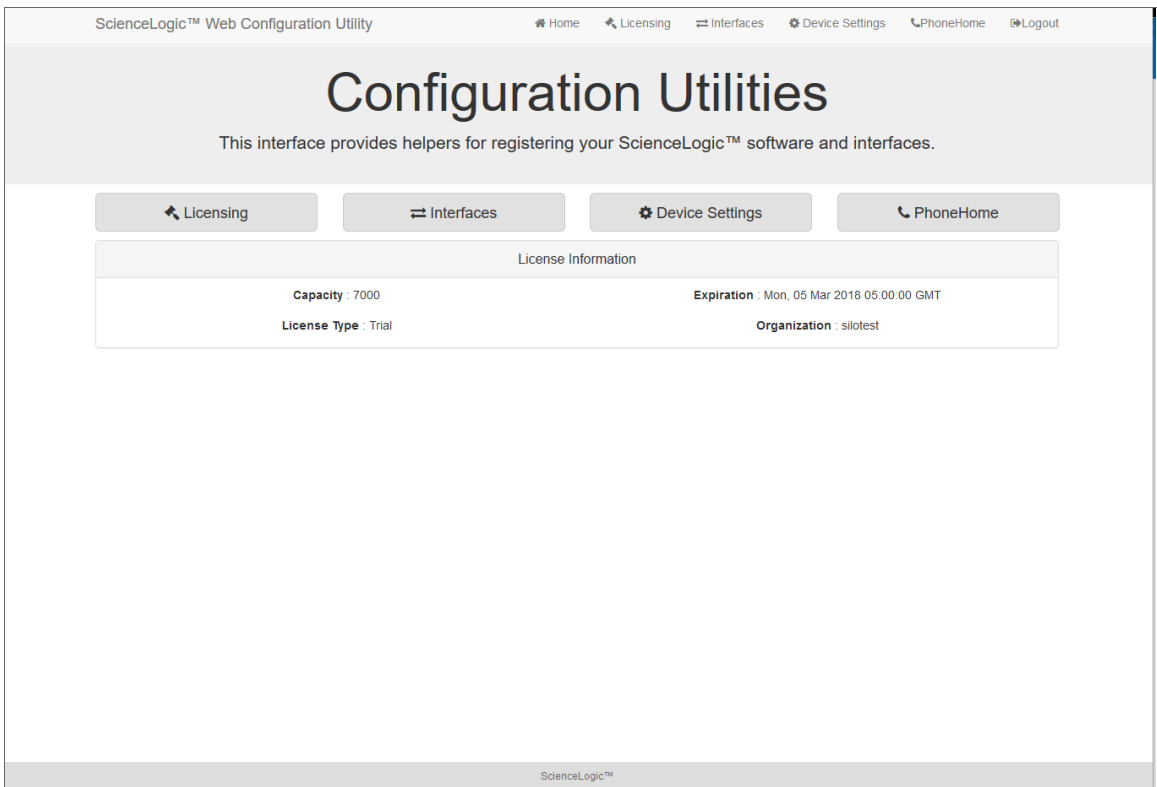

5. Click the [**Device Settings**] button. The **Settings** page appears.

ScienceLogic™ Web Configuration Utility

Home Licensing Interfaces Device Settings PhoneHome Logout

Settings

Configure your appliance.

Web Configuration Username em7admin	Web Config Password (change only) <input type="password"/>	Confirm Web Config Password <input type="password"/>
Appliance Type Administration Portal	Database IP Address 10.64.171.130	
Database Username root	Database Password (change only) <input type="password"/>	Confirm Database Password <input type="password"/>
GUI Username root	GUI Password (change only) <input type="password"/>	Confirm GUI Password <input type="password"/>

Save

Edit Files

chrony.conf silo.conf chrony.d/servers.conf

Configure Proxy Server

Server URL: **Port:**

Save

ScienceLogic™

6. Enter values in the following fields:
 - **Server URL.** Type the URL of the proxy server. For example, "http://10.2.12.51".
 - **Port.** Type the port on the proxy server to which the ScienceLogic appliance will talk.
7. Click **[Save]**.

Configuring the ScienceLogic Platform for PhoneHome Communication

Overview

This chapter explains how to configure the ScienceLogic platform to use PhoneHome Communication.

The following topics cover the details of configuring PhoneHome Communication:

<i>What is PhoneHome Communication?</i>	47
<i>Prerequisites</i>	49
<i>Overview of the PhoneHome Configuration</i>	49
<i>Configuring the Database Server for PhoneHome</i>	50
<i>Configuring the Data Collectors and Message Collectors for PhoneHome</i>	51
<i>Registering the Data Collectors and Message Collectors</i>	56
<i>Defining Port Forwarding</i>	58
<i>Importing and Exporting a PhoneHome Configuration</i>	59
<i>Using Custom Options for AutoSSH</i>	59
<i>Configuring PhoneHome for High Availability and Disaster Recovery</i>	60
<i>Configuring One or More Proxy Servers</i>	65
<i>The Watchdog Service</i>	70
<i>Logging PhoneHome Configuration Information</i>	71
<i>Using the Command-Line Interface</i>	71
<i>Troubleshooting the PhoneHome Configuration</i>	77

What is PhoneHome Communication?

The ScienceLogic platform supports two methods for communication between Database Servers and the Data Collectors and Message Collectors in a system:

The traditional method, where the Database Server initiates communication with each Data Collector and Message Collector. The Database Server periodically pushes configuration data to the Data Collectors and Message Collectors and retrieves data from the Data Collectors and Message Collectors.

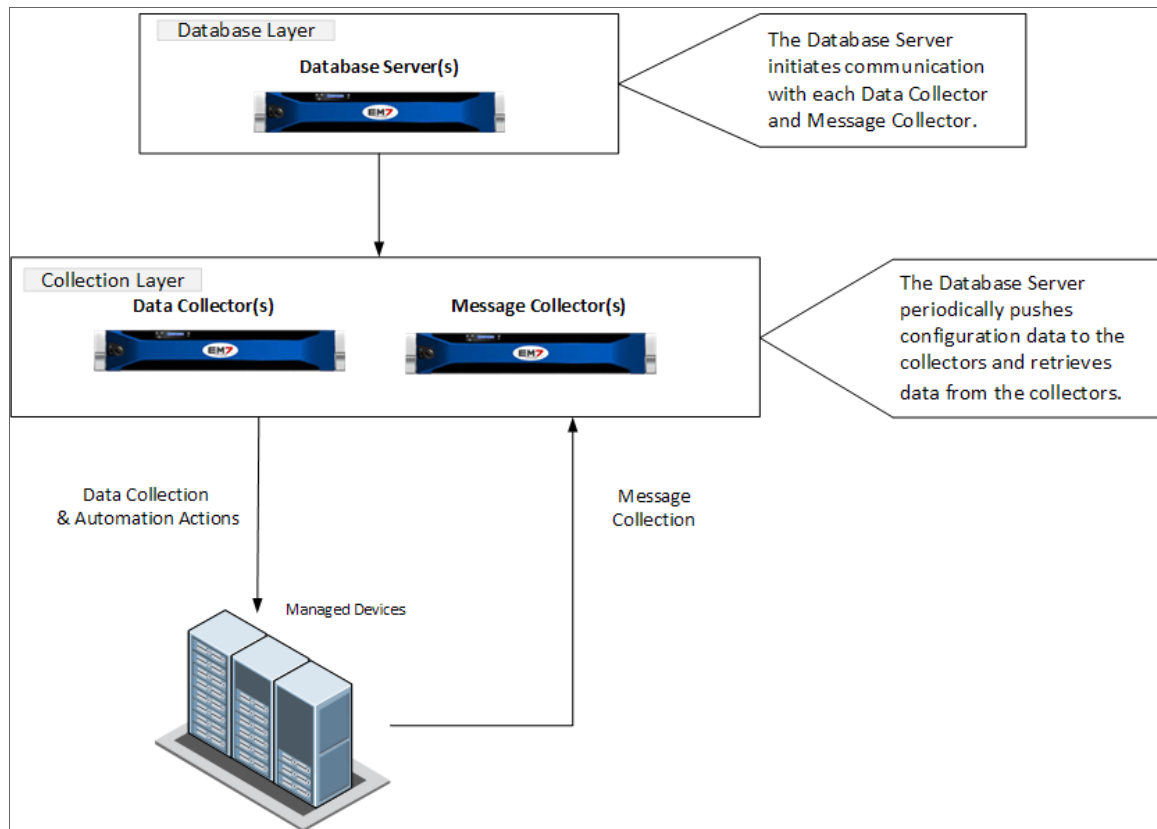

The benefit of this method is that communication to the Database Server is extremely limited, so the Database Server remains as secure as possible.

The PhoneHome method, where the Data Collectors and Message Collectors initiate communication with the Database Server. The Database Server then creates an SSH tunnel. The Database Server uses the SSH tunnel to periodically push configuration data to the Data Collectors and Message Collectors and retrieve data from the Data Collectors and Message Collectors.

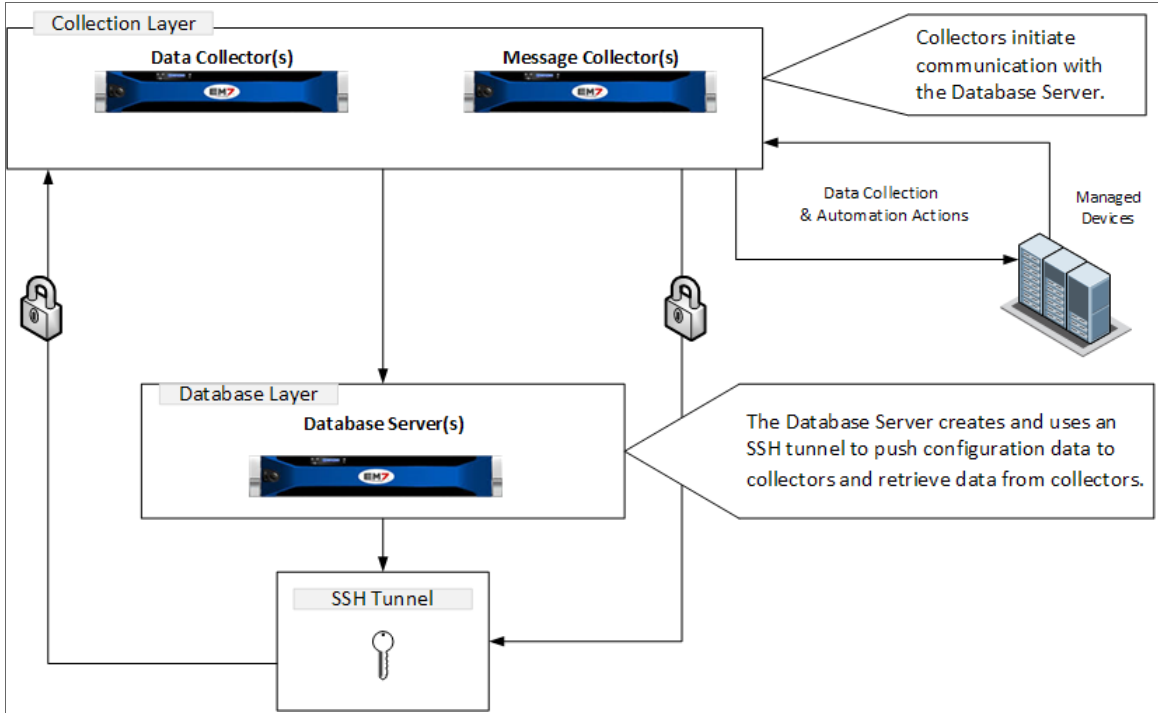

The benefits of this method are that no firewall rules must be added on the network that contains the Data Collectors, and no new TCP ports are opened on the network that contains the Data Collectors.

The PhoneHome configuration uses public key/private key authentication to maintain the security of the Database Server. Each Data Collector is aligned with an SSH account on the Database Server and uses SSH to communicate with the Database Server. Each SSH account on the Database Server is highly restricted, has no login access, and cannot access a shell or execute commands on the Database Server.

Prerequisites

Before configuring PhoneHome communication in your ScienceLogic environment, you must:

- Have SSH access or console access to each database.
- On each ScienceLogic appliance, know the username and password for access to the console as **em7admin**.
- Ensure that the Database Server opens a port for PhoneHome communication. The default port used by the Configuration Utility is **7705**, but you can use other ports besides 7705.

NOTE: If you use a proxy in your PhoneHome configuration, [perform the steps in the proxy section](#) before configuring the other steps in the PhoneHome configuration. The remaining configuration steps require the proxy for communication.

Overview of the PhoneHome Configuration

For a configuration that includes one or more Database Servers, perform the following steps to use PhoneHome communications:

1. [Configure one or more Database Servers for PhoneHome](#). Each Database Server must have the ScienceLogic platform installed, have an IP address, and be licensed with ScienceLogic.

NOTE: If you are using a High Availability and Disaster Recovery configuration, see [Configuring PhoneHome for High Availability and Disaster Recovery](#) to configure Database Servers.

2. [Configure the Data Collectors and Message Collectors for PhoneHome](#). Each Data Collector or Message Collector must have the ScienceLogic platform installed and have an IP address.
3. [Define the Database Server](#) associated with each Data Collector or Message Collector appliance.
4. [Register the Data Collectors and Message Collectors](#) in the ScienceLogic platform.
5. As needed, [define port forwarding](#) for each collector to use SSH from the Database Server to access that Data Collector or Message Collector.
6. See the [Troubleshooting section](#) for additional help.

NOTE: You do *not* need to license collectors if your ScienceLogic system is built from the 8.1.2 ISO or later. If your ScienceLogic system is built from the 8.1.1 ISO or earlier, you will have to license each Data Collector and Message Collector. For details on licensing Data Collectors and Message Collectors, see the **Licensing an Appliance** chapter in the 7.8 version of the **Installation and Initial Configuration** manual.

Configuring the Database Server for PhoneHome

In PhoneHome communication, the Database Server that communicates with the Data Collectors and the optional Message Collectors is known as the **Control Node**. The Control Node stores all the configuration information for the PhoneHome configuration.

NOTE: In a high-availability or disaster recovery system, the Control Node is usually also the primary Database Server. For more information about high availability and disaster recovery configuration, see [Configuring PhoneHome for High Availability and Disaster Recovery](#).

To configure the Control Node Database Server for PhoneHome communication, you must first perform the following required steps:

- Install the the ScienceLogic platform on the Database Server.
- Assign an IP address to the Database Server.
- License the Database Server with ScienceLogic. For more information, see [Licensing and Configuring a Database Server](#).

Next, configure the Control Node Database Server for PhoneHome communication:

1. Go to the console of the Database Server or use SSH to access the server.
2. Log in as user **em7admin** with the password you configured during setup.
3. For the Database Server, you must open a port to accept incoming connection requests. To do this, type the following at the shell prompt:

```
sudo phonehome open-control-port port_number
```

where *port_number* is an unused port number greater than 1000. The Configuration Utility uses port 7705 as the default port. If you want to use the default port, specify **7705** in this command. To use a *different* port, specify that port number in this command.

4. To define the Database Server (to itself), type the following at the shell prompt:

```
sudo phonehome add database
```

5. Review the output, which should look like the following:

```
Created local: #0
Reloading sshd configurations
Created database: #11
Changing password for user: "phonehome11"
Created Device Id: "11"
Created token: "phonehome://11@71.97.6.197/ee4sdRRK8yNu"
```

6. Note the ID number for the database (**11** in our example).
7. If the database is behind a firewall, you need to define the public-facing IP address of the Database Server and also define the port to use for SSH communication from PhoneHome servers to the Database Server. To do this, type the following at the shell prompt:

```
sudo phonehome set appliance_ID -ip=IP_address -port=port_number
```

where *appliance_ID* is the value you noted in step 6, *IP_address* is the public-facing IP address, and *port_number* is the port you want to use for SSH communication to and from the Database Server.

For example:

```
sudo phonehome set 11 -ip=71.197.6.197 -port=7705
```

8. You must now configure the Data Collectors and Message Collectors in your network. To do this, go the next section.

Configuring the Data Collectors and Message Collectors for PhoneHome

This section describes how to configure a Data Collector and a Message Collector for use in a PhoneHome configuration.

Before configuring a Data Collector and a Message Collector for use in a PhoneHome configuration, you must first perform the following required steps:

- Install the ScienceLogic platform on each Data Collector and Message Collector
- Assign an IP address to each Data Collector and Message Collector

NOTE: If your PhoneHome configuration uses proxy servers, do not use this section to configure a Data Collector or Message Collector. See the [section on proxy servers](#) instead.

To configure a Data Collector or Message Collector as part of a PhoneHome configuration:

1. On the Data Collector or Message Collector, log in to the Web Configuration Utility using any web browser supported by the platform. The address of the Web Configuration Utility is in the following format:

```
https://ip_address_of_collector:7700
```

2. Type the address of the Web Configuration Utility in the Address bar of your browser, replacing "ip-address-of-appliance" with the IP address of the Data Collector or Message Collector.
3. When prompted to enter your user name and password, log in as the "em7admin" user with either the default password of **em7admin** or the password you configured.

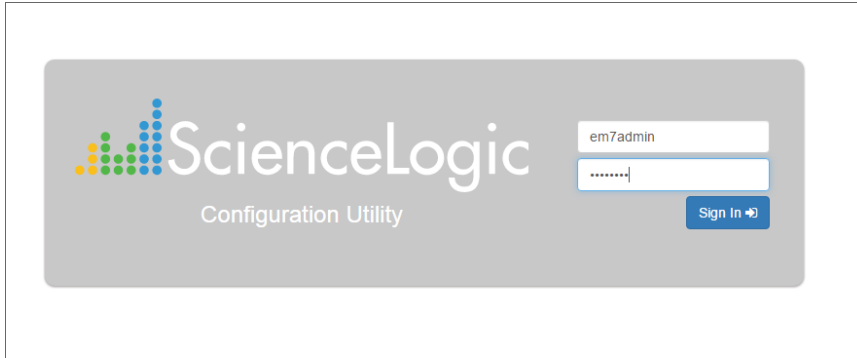

4. After you log in, the **Configuration Utilities** page appears:

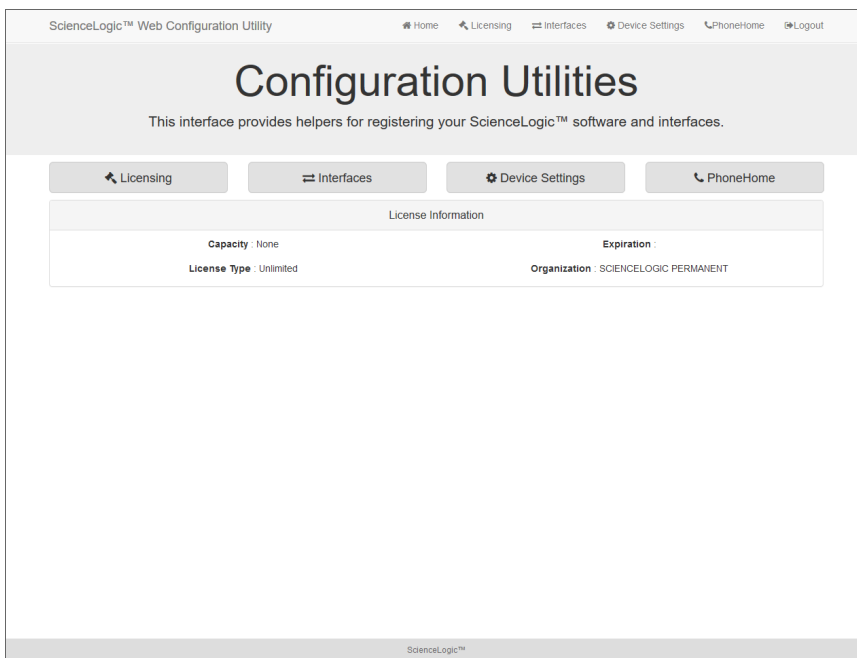

5. Click the **[PhoneHome]** button. The **PhoneHome - Collector** page appears.

ScienceLogic™ Web Configuration Utility

Home Licensing Interfaces Device Settings PhoneHome Logout

PhoneHome - Collector

Connect to a phonehome-configured database

Clear Configuration

Database:

Hostname/IP: 10.64.20.100 Port (if not 7705): 7706

Make request via HTTPS

Status: Not configured

Send Connection Request

ScienceLogic™

6. Complete the following fields:

- **Hostname/IP.** Type the Hostname or IP address of the Database Server that is configured for PhoneHome.
- **Port (if not 7705).** Optional. Port number for SSH communications with the Database Server that is configured for PhoneHome. If you are using a port *other* than 7705 on the Database Server, type the port number in this field. Otherwise, leave this field blank.
- **Make request with the Web Configuration Utility via HTTPS.** Optional. If you select this checkbox, the Data Collector sends the PhoneHome request to the Database Server using an HTTPS request. The Data Collector sends the request directly to the ScienceLogic Web Configuration Utility (port 7700) on the Database Server. This option works only if the Data Collector has direct access to port 7700 on the Database Server. If you do not select this checkbox, requests are made via SSH.
- **Verify SSL Cert.** Optional. When you use HTTPS, the Database Server sends an SSL certificate. If the certificate is from a Certificate Authority and must be verified, select this checkbox. If the certificate is internal and does not require verification, do *not* select this checkbox.

- Click the **[Send Connection Request]** button to send the request from the Data Collector to the Database Server that is configured for PhoneHome. After clicking the **[Send Connection Request]** button, the **PhoneHome - Collector** page displays the status *Pending database approval*.

NOTE: Do not close the browser window or navigate away from this page while the connection request is being processed.

- In a new browser window, open the ScienceLogic Web Configuration Utility for the Database Server. To do this, type the following, replacing "ip-address-of-database" with the IP address of the Database Server:

```
https://ip_address_of_database:7700
```

- When prompted to enter your user name and password, log in as the "em7admin" user with either the default password of **em7admin** or the password you configured. The main **Configuration Utility** page appears.
- Click the **[PhoneHome]** button. The **PhoneHome Database - Master** page appears.

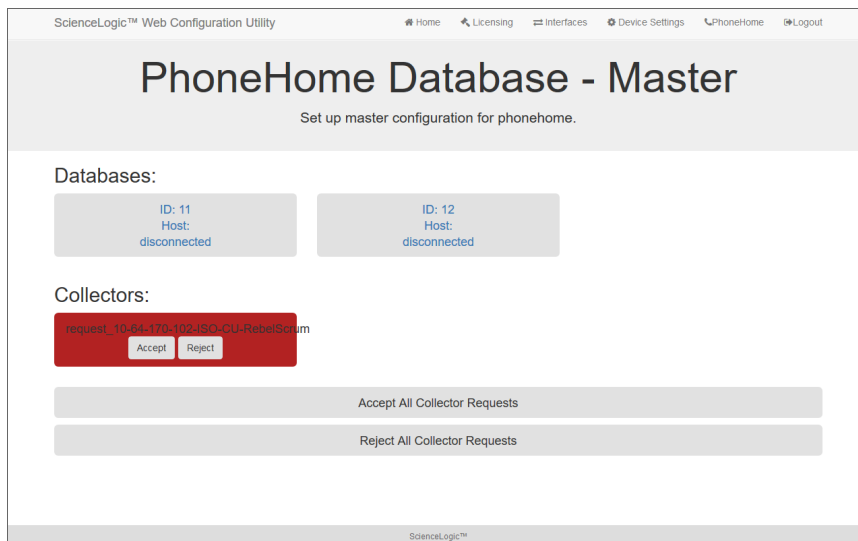

- Note that the list of Collectors includes a request. Click the **[Accept]** button for that collector. The Status for the Collector now displays as *Approved*.

12. On the Data Collector or Message Collector, open the ScienceLogic Web Configuration Utility and click the **[PhoneHome]** button. The **PhoneHome - Collector** page appears:

ScienceLogic™ Web Configuration Utility

Home Licensing Interfaces Device Settings PhoneHome

PhoneHome - Collector

Connect to a phonehome-configured database

Clear Configuration

Database:

Hostname/IP: 10.2.253.245 Port (if not 7705): 7705

Make request via HTTPS

Status: Configured - ID #81

Send Connection Request

ScienceLogic™

13. Click the **[Check Approval]** button. Note that the Status message is now *Configured - ID [phonehome_user_number]*.
14. If you refresh the page, the status field displays the message *Synced and Connected*.

If you have a large number of collectors, you can perform the following steps to approve multiple collectors at the same time:

1. On each Data Collector or Message Collector, follow steps 1-7 in the [previous procedure](#) to send the connection request for each collector.
2. Open the ScienceLogic Web Configuration Utility for the Database Server and click the **[PhoneHome]** button.
3. Click the **[Accept All Collector Requests]** button.
4. Open the ScienceLogic Web Configuration Utility for each collector, click the **[PhoneHome]** button, and then click the **[Check Approval]** button.
5. Repeat step 4 until you have approved all of your collectors.

Registering the Data Collectors and Message Collectors

NOTE: Perform the steps in this section after you have successfully established a PhoneHome connection between Data Collectors or Message Collectors and the main Database Server. The steps in this section ensure that the ScienceLogic system uses the loopback address that is assigned to each Data Collector and Message Collector upon [successful completion of a phonehome connection request](#).

In this section:

- In the Web Configuration Utility, you must define the Database Server associated with each Data Collector or Message Collector appliance.
- In the ScienceLogic platform, you must register the Data Collectors or Message Collectors with the main Database Server.

Define the Database Server for Each Collector

You must perform the following steps in the Web Configuration Utility to configure a Data Collector or a Message Collector:

1. Log in to the Web Configuration Utility on the Data Collector or the Message Collector. The **Configuration Utilities** page appears.
2. Click the **[Device Settings]** button. The **Settings** page appears.

The screenshot shows the 'Settings' page in the ScienceLogic Web Configuration Utility. The page title is 'Settings' with the subtitle 'Configure your appliance.' The navigation bar includes 'Home', 'Licensing', 'Interfaces', 'Device Settings', 'PhoneHome', and 'Logout'. The main content area contains several configuration fields: 'Web Configuration Username' (em7admin), 'Web Config Password (change only)' (empty), 'Confirm Web Config Password' (empty), 'Appliance Type' (Collection Unit), and 'Database IP Address(s) - comma separated, no spaces' (10.2.3.16). A 'Save' button is located below the IP address field. At the bottom, there is an 'Edit Files' section with buttons for 'chrony.conf', 'silo.conf', and 'chrony d/servers.conf'.

3. On the **Settings** page, update the following field:
 - **Database IP Address.** The IP address of the ScienceLogic Database Server(s). If more than one Database Server will manage this appliance, type the IP addresses of the Database Servers, separated by commas. You *cannot* paste an IP address into this field.
4. Click the **[Save]** button.
5. Click the **[Logout]** button to log out of the Web Configuration Utility for this collector.
6. Perform steps 1-5 for each Data Collector and Message Collector in your PhoneHome configuration.

Register the Collectors with the Main Database Server

In the ScienceLogic platform, to register a Data Collector or Message Collector with the main Database Server:

1. In the address bar of your browser, type the IP address of the ScienceLogic appliance that provides the user interface for your ScienceLogic system. The user interface is provided by either the Database Server or an Administration Portal. The login page appears:



2. Log in as the "em7admin" user with the password "em7admin" (or the password you configured).
3. If this is your first successful login, you will be asked to agree to the End-user License Agreement. Read the End-user License Agreement and then click the **[I Agree to The Terms Outlined Above]** button.
4. Go to the **Appliance Manager** page (System > Settings > Appliances):

<p>Host Name</p> <input type="text" value="PhoneHome collector 5"/>	<p>Model type</p> <input type="text" value="Data Collection Unit [5]"/>	<p>Save</p> <p>Save As</p>
<p>IP Address</p> <input type="text" value="127.0.0.5"/>	<p>Description</p> <input type="text" value="Data Collector 05"/>	

5. Complete the following fields:

- **Host Name.** Type the host name of the Data Collector or Message Collector.
- **IP Address.** Type the **loopback IP address** of the Data Collector or Message Collector. The loopback IP address is a special, virtual network interface that your computer uses to communicate with itself. This address also allows you to view content on a server in the same way a client would. In most cases, the loopback address is 127.0.0.1, although the loopback address can be any IP address in the 127.0.0.0/8 block.

TIP: If you go to the Web Configuration Utility of the Database Server and click the **PhoneHome** button, you can view a list of all the connected collectors, along with their IDs. The ID indicates the loopback address. For example, if the ID of a given collector is 12, then its loopback address is 127.0.0.12.

- **Model Type.** Select the type of appliance (Data Collector or Message Collector) you are registering.
 - **Description.** Type a description for the Data Collector or Message Collector. This field is optional.
6. Click the **[Save]** button. If the save is successful, the message "Appliance Registered" displays.
 7. If all information is valid and the Database Server can communicate with the Data Collector or Message Collector, the **Appliance Manager** page displays the ScienceLogic version installed on the collector in the **Build** column. If the **Build** column remains blank for longer than five minutes, double-check your settings and network connection.
 8. Perform these steps for each Data Collector and Message Collector in your PhoneHome configuration.

Defining Port Forwarding

If you define port forwarding for each Data Collector or Message Collector in the PhoneHome configuration, you can use SSH from the Database Server to access the Data Collector or Message Collector.

To define port forwarding:

1. Either go to the console of the Database Server or use SSH to access the server.
2. Log in as user **em7admin** with the password you configured during setup.
3. For each Data Collector and/or Message Collector, type the following at the shell prompt:

```
sudo phonehome set appliance_ID -forwards=port_number
```

where:

- *appliance_ID* is device ID for the Data Collector or Message Collector.
- *port_number* is the port you want to use for SSH communication from the Database Server to the Data Collector or Message Collector.

For example:

```
sudo phonehome set 12 -forwards=22
```

4. For every other server in the PhoneHome configuration, go to the console of the Database Server or use SSH to access the server.
5. Log in as user **em7admin** with the password you configured during setup.
6. Type the following at the shell prompt:

```
sudo phonehome sync
```

7. Now, whenever you are SSHed in to the Database Server, you can SSH to the Data Collector or Message Collector.
8. To use the forward port, append "100" to the front of the port you defined in step #3 and use the loopback IP of the Data Collector or Message Collector using port 10022:

```
ssh -p 10022 root@127.0.0.12
```

Importing and Exporting a PhoneHome Configuration

From the Database Server, you can export the details of your PhoneHome configuration to a file. If your Database Server fails, you can import the PhoneHome configuration file to a new Database Server (as long as the new Database Server has the same IP address of the failed Database Server), and you will not have to perform any additional configuration steps to get your PhoneHome configuration running again.

To export the details of your PhoneHome configuration to a file:

1. Log in to the console of the primary Database Server as the root user.
2. At the command line, type the following:

```
phonehome export -f filename
```

where *filename* is the full path name of the file in which you want to store the exported configuration.

3. Copy the file to a secure location, not on the Database Server.

To import the details of your PhoneHome configuration to a new Database Server:

1. Log in to the console of the new primary Database Server as the root user.
2. At the command line, type the following:

```
phonehome import -f filename
```

where *filename* is the full path name of the file that contains the exported PhoneHome configuration.

Using Custom Options for AutoSSH

By default, the ScienceLogic platform stores settings for AutoSSH for PhoneHome configurations in the file `/opt/em7/backend/phonehome/em7_ph_tunnels` on each Data Collector and Message Collector in your configuration.

If you want to use custom AutoSSH settings for a specific Data Collector or Message Collector in your configuration, you can create the file `/etc/phonehome/local.conf` and define custom AutoSSH options for that server.

To define custom SSH options for a server:

1. Log in to the console of the Data Collector or Message Collector as the root user.
2. Open the file `/etc/phonehome/local.conf` with a text editor like vi:

```
vi /etc/phonehome/phonehome.conf
```

3. Add one or more custom settings for AutoSSH. You can define:
 - `TCPKeepAlive = "number of seconds"`. The number of seconds the client will wait before sending a null packet to the server (to keep the connection alive). Uses the TCP layer to send the packet. If you set this value to zero (0), this feature is disabled. Your connection will drop if idle for too long.
 - `ServiceAliveInterval = "number of seconds"`. The number of seconds the client will wait before sending a null packet to the server (to keep the connection alive). Uses the SSH layer to send the packet. If you set this value to zero (0), this feature is disabled. Your connection will drop if idle for too long.
 - `StrictHostKeyChecking = "yes or no"`. If this flag is set to "yes", AutoSSH will never automatically add host keys to AutoSSH configuration and will refuse to connect to hosts whose host key has changed. This option forces the user to manually add all new hosts. If this flag is set to "no", ssh will automatically add new host keys to the known hosts files.

NOTE: To determine the format for entries in the `/etc/phonehome/phonehome.conf` file, see the file `/opt/em7/backend/phonehome/em7_ph_tunnels`.

4. Save your changes and exit the file.

Configuring PhoneHome for High Availability and Disaster Recovery

This section describes how to configure the Database Servers in your system for use in a PhoneHome configuration.

NOTE: You can use the same Database Servers in both a PhoneHome configuration and a traditional configuration.

After performing the steps in this section, go the section on [Configuring the Data Collectors and Message Collectors](#) to complete the configuration.

What is the Control Node?

In a PhoneHome configuration, the Control Node is the Database Server that communicates with the Data Collectors and the optional Message Collectors. This Database Server stores all the configuration information for the PhoneHome configuration.

In a high-availability or disaster recovery system, the Control Node is usually also the primary Database Server .

Configuring the Control Node Database Server for High Availability and Disaster Recovery

To configure the Control Node for PhoneHome communication:

1. Go to the console of the Control Node Database Server or use SSH to access the server.
2. Log in as user **em7admin** with the password you configured during setup.
3. For the Control Node Database Server, you must first open a port to accept incoming connection requests. To do this, type the following at the shell prompt:

```
sudo phonehome open-control-port port_number
```

where *port_number* is an unused port number greater than 1000. The default value in the Configuration Utility is 7705. If you want to use the default port later in the Configuration Utility, specify "7705" in this command.

4. To define the Control Node Database Server (to itself), type the following at the shell prompt:

```
sudo phonehome add database
```

5. Review the output, which should look like the following:

```
Created local: #0
Reloading sshd configurations
Created database: #11
Changing password for user: "phonehome11"
Created Device Id: "11"
Created token: "phonehome://11@71.97.6.197/ee4sdRRK8yNu"
```

6. Note the ID number for the Control Node (**11** in our example).
7. To define the public-facing IP address of the Control Node Database Server and the port to use for SSH communication from PhoneHome servers to the Control Node Database Server, type the following at the shell prompt:

```
sudo phonehome set appliance_ID -ip=IP_address -port=port_number
```

where *port_number* is an unused port number greater than 1000. The Configuration Utility uses port 7705 as the default port. If you want to use the default port, specify **7705** in this command. To use a *different* port, specify that port number in this command.

For example:

```
sudo phonehome set 11 -ip=71.197.6.197 -port=7705
```

8. If your ScienceLogic system uses multiple databases for high availability and/or disaster recovery, you must create a record for the secondary Database Server on the Control Node Database Server. To do so, type the following at the shell prompt:

```
sudo phonehome add database
```

9. The output will look like this:

```
Reloading sshd configurations
Created database: #13
Changing password for user: "phonehome13"
Created Device Id: "13"
Created token: "phonehome://13@10.64.68.31:22/GmHtYvDd9O0V"
```

10. Note the ID number for the secondary Database Server. You will need this value later in the configuration.
11. Copy and save the token for the secondary Database Server. You will need this value later in the configuration.
12. To define the public-facing IP address of the secondary Database Server and the port to use for SSH communications from PhoneHome servers to the secondary Database Server, type the following at the shell prompt:

```
sudo phonehome set appliance_ID -ip=IP_address -port=port_number
```

where:

- *appliance_ID* is the value you noted in step 5.
- *IP_address* is the public-facing IP address.
- *port_number* is the port you want to use for SSH communication to and from the Control Node Database Server.

For example, we could enter:

```
sudo phonehome set 13 -ip=71.197.6.198 -port=7705
```

Configuring the Secondary Database Server for High Availability and Disaster Recovery

To configure a secondary Database Server as part of a PhoneHome configuration:

1. Either go to the console of the secondary Database Server or use SSH to access the server.
2. Log in as user **em7admin** with the password you configured during setup.

3. For the secondary Database Server, you must first open a port to accept incoming connection requests. To do this, type the following at the shell prompt:

```
sudo phonehome open-control-port port_number
```

where:

- *port_number* is an unused port number greater than 1000. The default value in the Configuration Utility is 7705. If you want to use the default value, specify "7705".

NOTE: ScienceLogic recommends that you use the same port number on each database in your PhoneHome configuration.

4. To register the secondary Database Server, type the following at the shell prompt:

```
sudo phonehome register appliance_token
```

where:

- *appliance_token* is the URL you saved during step 10 in the section [Configuring the Control Node Database Server](#).

5. The output looks like this:

```
Registered device successfully
```

6. Type the following at the shell prompt:

```
sudo phonehome sync
```

7. The output looks like this:

```
Started synchronization  
Synchronized: collectors  
Synchronized: databases  
Reloading sshd configurations  
Finished synchronizations
```

Configuring Data Collectors and Message Collectors for High Availability and Disaster Recovery

You must now configure the Data Collectors and Message Collectors in your network. To do this, see [Configuring the Data Collectors and Message Collectors](#).

NOTE: If your PhoneHome configuration uses proxy servers, do not use this section to configure a Data Collector or Message Collector. See the [section on proxy servers](#) instead.

Syncing the High Availability and Disaster Recovery System

After adding Data Collector(s) or Message Collector(s) to your PhoneHome configuration, you must once again execute the sync command on all **Database Servers** and then on the newly configured Collectors in the PhoneHome configuration.

To sync your PhoneHome configuration:

1. Either go to the console of the Database Server (or the new Collectors) or use SSH to access the server.
2. Log in as user **em7admin** with the password you configured during setup.
3. At the shell prompt, type the following:

```
sudo phonehome sync
```
4. Perform these steps on each Database Server, Data Collector, and Message Collector in your PhoneHome configuration.

Changing the Control Node for High Availability and Disaster Recovery

This section explains how to perform fail-over to the secondary Database Server if the primary Database Server fails or is offline.

This section requires you to use the command-line interface.

NOTE: The **watchdog** and **autosync** services are not available for versions of the ScienceLogic platform **earlier than the 7.5.3 ISO**. If you are using a version of the ScienceLogic platform **earlier than the 7.5.3 ISO**, please contact ScienceLogic Customer Care for help performing the steps in this section.

To promote a secondary Database Server:

1. Determine the Database Server that you want to promote (to Control Node). Log in to the console of that Database Server or use SSH to access the server. Log in as **em7admin**.
2. At the shell prompt, type the following:

```
phonehome clear all
```
3. On the Database Server that you want to promote, perform all of the steps in all of the sub-sections in the section [Configuring the Control Node Database Server](#).
4. For each secondary Database Server, perform all of the steps in the section [Configuring the Secondary Database Server for High Availability and Disaster Recovery](#).
5. For each Data Collector and Message Collector, perform all of the steps in the section [Configuring the Data Collector and Message Collector for PhoneHome](#).

6. For each Data Collector and Message Collector, perform all of the steps in the section [Synchronizing the Database Servers with the New Data Collector and Message Collector in a High Availability Configuration](#).

Adding a New Secondary Database Server

To add a new secondary Database Server to an existing PhoneHome configuration:

1. On the primary Database Server (the Control Node), perform steps 15-19 from the section [Configuring the Primary Database Server](#). These are the steps that define the secondary Database Server, including saving the token and saving the new configuration.
2. On the new secondary Database Server, perform the steps from the section [Configuring the Secondary Database Server for High Availability and Disaster Recovery](#).
3. For each Data Collector and optional Message Collector, either go to the console of the ScienceLogic appliance or use SSH to access the Data Collector. Log in as "em7admin".
4. At the shell prompt, type the following:

```
phonehome sync
```

5. Perform steps 3 and 4 on each Data Collector and Message Collector in the PhoneHome configuration.
6. Either go to the console of the ScienceLogic appliance or use SSH to access the new secondary Database Server. Log in as "root".
7. At the shell prompt, type the following:

```
phonehome status
```

8. The new secondary Database Server should be connected to each Data Collector in the PhoneHome configuration.

Configuring One or More Proxy Servers

If your organization requires that you use a proxy for outbound requests, you can configure one or more Data Collectors to act as proxy servers. These proxy servers will sit between the Data Collectors in your PhoneHome configuration and the Database Server in your PhoneHome configuration.

To use one or more Data Collectors as proxy servers in a PhoneHome configuration:

- Ensure that the SSH port is open on each Data Collector that acts as a proxy server.
- Ensure that the SSH port is open on each Database Server in the PhoneHome configuration.

NOTE: If you use a proxy in your PhoneHome configuration, **perform the steps in this section before you configure the other steps in this chapter**. The other steps in the PhoneHome configuration will require the proxy for communication.

To configure your PhoneHome configuration to use a proxy server, you must:

1. Configure a Database Server for PhoneHome configuration as either a stand-alone Database Server ([Configuring the Database Servers](#)) or a High Availability Database Server ([Configuring the Database Servers for High Availability](#))
2. [Edit the ssh_config file.](#)
3. Use the command line to configure Data Collectors *that connect via proxy*.
4. [Copy the SSH key to each proxy](#)
5. [Synchronize the](#) Data Collectors with the Database Server.

Editing ssh_config

1. Either go to the console of the Data Collector that will be part of the PhoneHome configuration or use SSH to access the server.

NOTE: Perform these steps on the Data Collector that will be part of the PhoneHome configuration, *not on the Data Collector that will serve as a proxy server.*

2. Log in as user **em7admin** with the password you configured during setup.
3. Open the file `/etc/ssh/ssh_config` with `vi` or another text editor:

```
sudo vi /etc/ssh/ssh_config
```

4. Add the following lines to the file:

```
Host hostname_of_primary_Database_Server  
  
ProxyCommand ssh -q em7admin@proxy_hostname nc %h %p
```

where:

hostname_of_primary_Database_Server is the hostname for the primary Database Server.

proxy_hostname is the hostname of the proxy server that directly communicates with the Database Server. If you have a chain of proxy servers, this value is the hostname of the last proxy server in that chain (the proxy server that connects to the Database Server).

NOTE: If you use hostnames to configure proxy servers, you must use hostnames for all PhoneHome configuration. If you use IP addresses to configure proxy servers, you must use IP addresses for all PhoneHome configuration. You cannot mix hostnames and IP addresses in `ssh_config` and in PhoneHome configuration.

5. If applicable, for all secondary databases, add the following lines to the file:

```
Host hostname_of_secondary_Database_Server
ProxyCommand ssh -q em7admin@proxy_hostname nc %h %p
```

where:

hostname_of_secondary_Database_Server is the hostname for the secondary Database Server.

proxy_hostname is the hostname of the proxy server that directly communicates with the secondary Database Server. If you have a chain of proxy servers, this value is the hostname of the last proxy server in that chain (the proxy server that connects to the Database Server).

6. If you have more than one proxy server, add the following lines to the file:

```
Host hostname_of_proxy_server
ProxyCommand ssh -q em7admin@proxy_hostname nc %h %p
```

where:

hostname_of_proxy_server is the hostname of the current proxy server (the proxy server you are creating an entry for). For example, you could create an entry for "ProxyServer2".

proxy_hostname is the hostname of the proxy server that is previous in the chain and communicates with the current proxy server. If your entry is for "ProxyServer2", you would specify "ProxyServer1" in this field.

For example, if you had the following configuration:

PhoneHome Data Collector -> ProxyServer1 -> ProxyServer2 -> ProxyServer3 -> Database Server

You would add the following entries to /etc/ssh/ssh_config:

```
Host ProxyServer2
ProxyCommand ssh -q em7admin@ProxyServer1 nc %h %p

Host ProxyServer3
ProxyCommand ssh -q em7admin@ProxyServer2 nc %h %p

Host EM7_DB1
ProxyCommand ssh -q em7admin@ProxyServer3 nc %h %p
```

For another example, if you had the following configuration:

PhoneHome Data Collector -> ProxyServer1 -> ProxyServer2 -> ProxyServer3 -> primary Database Server

PhoneHome Data Collector -> ProxyServer1 -> ProxyServer2 -> ProxyServer3 -> secondary Database Server

You would add the following entries to `/etc/ssh/ssh_config`:

```
Host ProxyServer2
ProxyCommand ssh -q em7admin@ProxyServer1 nc %h %p

Host ProxyServer3
ProxyCommand ssh -q em7admin@ProxyServer2 nc %h %p

Host EM7_DB1
ProxyCommand ssh -q em7admin@ProxyServer3 nc %h %p

Host EM7_DB2
ProxyCommand ssh -q em7admin@ProxyServer3 nc %h %p
```

7. Save (:wq) your changes to the `/etc/ssh/ssh_config` file.

Configuring Data Collectors that Connect to the PhoneHome Database Server Through a Proxy

To configure a Data Collector that connect to the PhoneHome Database Server through a Proxy:

1. Either go to the console of the Database Server or use SSH to access the server.
2. Log in as user **em7admin** with the password you configured during setup.
3. For the Database Server, you must first open a port to accept incoming connection requests. To do this, type the following at the shell prompt:

```
sudo phonehome open-control-port port_number
```

where:

- *port_number* is an unused port number greater than 1000.

4. To define the Data Collector (to the Database Server), type the following at the shell prompt:

```
sudo phonehome add collector
```

5. The output will look like this:

```
Created collector: #12
Changing password for user: "phonehome12"
Created Device Id: "12"
Created token: "phonehome://12@10.64.68.31:22/om3Odt3iPEAD"
```

6. Note the token for the Data Collector.
7. Either go to the console of the Data Collector or use SSH to access the server.

NOTE: Perform these steps on the Data Collector that will be part of the PhoneHome configuration, *not on the Data Collector that will serve as a proxy server.*

8. Register the Data Collector with the Database Server . To do this, type the following at the shell prompt:

```
sudo phonehome register token
```

where:

- *token* is the value you noted in step 5.

Copying the SSH key to Each Proxy

You must now copy the SSH key to each proxy server. To do this:

1. Either go to the console of the Data Collector that will be part of the PhoneHome configuration (not the proxy server) or use SSH to access the server.
2. Log in as user **em7admin** with the password you configured during setup.
3. At the shell prompt, type the following:

```
ssh-copy-id -i /home/phonehome0/.ssh/id_rsa.pub em7admin@[IP_address_of_proxy_server]
```

4. Perform step 3 for each proxy server in your PhoneHome configuration.

Synchronize the Data Collectors with the Database Server

After adding Data Collector(s) or Message Collector(s) to your PhoneHome configuration, you must execute the `sync` command on all **Database Servers** in the PhoneHome configuration.

To execute the `sync` command on all Database Servers:

1. Either go to the console of the Database Server or use SSH to access the server.
2. Log in as user **em7admin** with the password you configured during setup.
3. At the shell prompt, type the following:

```
sudo phonehome sync
```

4. Perform these steps on each Database Server in your PhoneHome configuration.

The Watchdog Service

Each Data Collector and Message Collector in a PhoneHome configuration runs a service called watchdog. The watchdog process automatically checks the connection between the Data Collector or Message Collector and the Database Server. If the connection is stale, the watchdog service automatically forces the Database Server to reconnect to the Data Collector or Message Collector.

The watchdog service can also detect configuration changes. If the PhoneHome configuration changes, the watchdog service will detect the changes and synchronize the configuration data on each device in the PhoneHome configuration.

The watchdog service is started automatically on each Data Collector, Message Collector, and secondary Database Server.

To view information about the watchdog service:

1. Log in to the console of the Data Collector, Message Collector, and secondary Database Server as the root user.
2. At the command line, type the following:

```
phonehome watchdog view
```

3. You should see something like the following:

```
Current settings:
```

```
autosync: yes
interval: 20
state: enabled
autoreconnect: yes
timeoutcount: 2
check: default
```

4. You can change any of these settings by typing the following at the command line:

```
phonehome watchdog set -settingvalue
```

where *setting* is one of the settings displayed with the *view* command and *value* is the value to assign to that setting.

5. For details about the watchdog service, type the following at the command line:

```
phonehome watchdog help
```

For details about the arguments and settings for watchdog, see the section on [Using the Command Line Interface](#).

Logging PhoneHome Configuration Information

The PhoneHome configuration logs information to the following files:

- **`/var/log/phonehome/phonehome0.log`**. Resides on each device in the PhoneHome configuration. This log file stores the date and time that devices are added to or removed from the PhoneHome configuration and each configuration action, including token generation, device registration, and configuration data synchronization, performed for each device.
1. **`/var/log/phonehome/phonehome<device ID>.log`**. Resides on the Control Node (usually the Database Server). This log file stores an entry for each action requested by or performed on a specific device (specified by device ID).
 2. **`/var/log/phonehome/ph_watchdog.log`**. Resides on the Control Node (usually the Database Server). This log file stores information about the watchdog service.

Using the Command-Line Interface

If you have access to the console for each appliance in the PhoneHome configuration, or if you have SSH access to each appliance in the PhoneHome configuration, you can use a shell session and the **phonehome** command to configure and troubleshoot your PhoneHome configuration.

The phonehome Command

To use the **phonehome** command:

1. Either go to the console of the ScienceLogic appliance or use SSH to access the server. Log in as "root".

NOTE: For details on enabling and using SSH with the ScienceLogic platform, see the manual Security .

2. At the command prompt, you can type the following:

phonehome *argument*

where *argument* is one of the following:

- **add** *appliance_type* or *request_file*. Run this command on the Control Node Database Server. Adds an appliance to the current PhoneHome configuration.
 - *appliance_type*. Type one of the following:
 - **collector**. Adds a Data Collector or Message Collector to the PhoneHome configuration.
 - **database**. Adds a Control Node secondary Database Server or a secondary Database Server to the PhoneHome configuration.
 - *request_file*. When the Data Collector or Message Collector sends a request to the Database Server, the Database Server creates a request file in the directory **/home/phonehomerequest/requests**. You can specify the full pathname of a request file to accept a request and add a new Data Collector or Message Collector to the PhoneHome configuration.

NOTE: The **phonehome add request_file** command performs the same operations as selecting the **[Accept]** button for a request in ScienceLogic Web Configuration Utility.

- **check -json** *yes*. Run this command on any appliance in the PhoneHome configuration. Executes diagnostic steps to aid in troubleshooting.

The **phonehome** command first tries to connect to the Control Node.

If you issue this command from a Database Server, the command checks the status of the database port, the SSH port, and port for the web configuration tool for each Data Collector and Message Collector.

If you issue this command from a Data Collector or Message Collector, the command checks the status of the database port, the SSH port, and port for the web configuration tool for each Database Server.

- **-json** *yes*. Displays output in json format.

- **clear** *clear_type*. Clears the PhoneHome configuration, as specified in the *clear_type* argument.
 - *clear_type*. Specifies which configuration to remove. Can be one of the following:
 - *client*. Run this command on the secondary Database Server, Data Collector, or Message Collector. Removes the PhoneHome connection (SSH tunnel). The appliance can then no longer connect to the Control Node Database Server.
 - *users*. Run this command on the Control Node Database Server. Removes the PhoneHome configuration for all appliances except the Control Node Database Server.
 - *all*. Run this command on the Control Node Database Server. Removes the PhoneHome configuration for the each Data Collector, Message Collector, secondary Database Server, and the primary Database Server.
- **close-control-port** *port_number*. Run this command on Database Servers (Control Node and secondary). Blocks future connection requests from Data Collectors and secondary Database Servers.
- **connect**. Run this command from the Data Collectors, Message Collectors, or secondary Database Server. Starts communication between the Control Node Database Server and the Data Collector, Message Collector, or secondary Database Server.
- **delete** *appliance_ID*. Run this command on the Control Node Database Server. Deletes an appliance from the current PhoneHome configuration.
 - *appliance_ID*. Enter the numeric ID of the appliance. You can find this ID with the **phonehome status** command.
- **disable** *appliance_ID*. Run this command on the Control Node Database Server. Disables a PhoneHome appliance.
 - *appliance_ID*. Enter the numeric ID of the appliance. You can find this ID with the **phonehome status** command.
- **disconnect**. Run this command from the Data Collector(s), Message Collector(s), or secondary Database Server. Stops communication between the Control Node Database Server and the Data Collector, Message Collector, or secondary Database Server.
- **enable** *appliance_ID*. Run this command on the Control Node Database Server. Enables a PhoneHome appliance.
 - *appliance_ID*. Enter the numeric ID of the appliance. You can find this ID with the **phonehome status** command.
- **export -f filename -pub_keys yes_or_no**. Run this command from the Control Node Database Server. Exports configuration file to a JSON file, stored on the local computer.
 - **-f filename**. Specifies that you want to export the configuration data to a file. The data is stored as a JSON file. By default, the export data is sent to standard output.
 - **-pub_keys yes_or_no**. Specifies whether to include public keys in the exported file.
- **help**. Run this command from any appliance in the PhoneHome configuration. Displays information about each parameter for the **phonehome** command.

- **help extra**. Run this command from any appliance in the PhoneHome configuration. Displays information about the basic steps to configure a PhoneHome configuration.
- **import -f filename**. Run this command from the Control Node Database Server. Imports the PhoneHome configuration previously generated with the export command.
- **mysql appliance_id**. Run this command on the Control Node Database Server. Tests the connection to the MySQL database. If the *appliance_ID* specifies a Data Collector or Message Collector, the **phonehome** command will test the MySQL connection using the loopback address of the Data Collector or Message Collector and port 7707. If the *appliance_ID* specifies a Database Server, the **phonehome** command will test the MySQL connection using the public IP address of the Database Server and port 7706.
 - *appliance_ID*. Enter the numeric ID of the appliance. You can find this ID with the **phonehome status** command.
- **open-control-port port_number**. Run this command on Database Servers (Control Node and secondary). Adds an entry for the specified SSH port to the /etc/sysconfig/iptables file on the current server.
- **reconnect**. Run this command from the Data Collector(s), Message Collector(s), or secondary Database Server. Stops and then restarts communication between the Control Node Database Server and the Data Collector(s), Message Collector(s), or secondary Database Server.
- **register device_token**. Run this command from the Data Collector(s), Message Collector(s), or secondary Database Server. Registers the appliance with the Control Node Database Server.

After you generate a **token** for a Data Collector or Message Collector (either with **phonehome token** or **phonehome add**), go to the Data Collector or Message Collector and use the **phonehome register** command to register the Data Collector or Message Collector with the Control Node Database Server. The Data Collector or Message Collector will then upload its public key to the Control Node Database Server and download its configuration for PhoneHome from the Control Node Database Server. After executing this command, the Data Collector or Message Collector will automatically connect to the Database Server.

In configurations that have multiple Database Servers: After you generate a **token** for a secondary Database Server (either with **phonehome token** or **phonehome add**), go to the secondary Database Server and use the **phonehome register** command to register the secondary Database Server with the primary Database Server. The secondary Database Server will then upload its public key to the primary Database Server and download its configuration for PhoneHome from the primary Database Server.

- *device_token*. Enter the token you generated for the Data Collector, Message Collector, or secondary Database Server.
- **reload**. Can be run on any appliance in the PhoneHome configuration. Stops the `em7_sshd` and `em7_ph_service` processes, finds and applies any configuration changes, and restarts the service.

- **request** [*protocol*]://[*database_IP*] [*no_verify*]. Run this command from the Data Collector or Message Collector to send a request to the Database Server.
 - *protocol*. Enter the protocol to use to send the request to the Database Server. Choices are *phonehome* or *https*.
 - *database_IP*. The IP address of the Database Server in the PhoneHome configuration.
 - *no_verify*. Optional. If you specified *https* in the **protocol** option, you can specify **no_verify** to disable SSL verification.

NOTE: The **phonehome request** command performs the same operations as sending a request to the Database Server from the ScienceLogic Web Configuration Utility. Specifying **no_verify** performs the same operation as not selecting the **Verify SSL Cert** checkbox.

You can use the **phonehome request** command and the **phonehome add request_file** command to add a Data Collector or Message Collector to a PhoneHome Configuration. Go to the Data Collector or Message Collector and use the **phonehome request** command to send a request to join the PhoneHome configuration. Go to the Database Server and use the **phonehome add request_file** command to accept the request from the Data Collector or Message Collector. Go to the Data Collector or Message Collector again and execute the **phonehome request** command a second time to retrieve the request approval and set up the connection.

- **set appliance_ID -parameter=value**. Run on the Control Node Database Server. For a specific device, assigns a value to a parameter:
 - *appliance_ID*. Enter the numeric ID of the appliance. You can find this ID with the **phonehome status** command.
 - *parameter*. Can be one of the following parameters, preceded by a dash:
 - *name*. Specifies the name of the device in the **Name** field in the Web Configuration Utility.
 - *ssh*. Specifies whether or not to enable port forwarding for the SSH port for this device. Possible values are "yes" or "no".
 - *ip*. Specifies the IP address of the device in the **IP Address** field in the Web Configuration Utility.
 - *forwards*. Enables port forwarding for one or more ports. Specify one or more port numbers, separated by a space.
 - *value*. Value to assign to the parameter, surrounded by double quotes.

For example:

```
phonehome set 11 -ssh yes -name "Reston"
```

- This example affects the device with an appliance ID of "11".
- The example enables port forwarding for SSH.
- The example enables port forwarding for the Web Configuration Utility.
- The example sets the device's device name to "Reston".

- **ssh** *appliance_id*. Run on the Control Node Database Server. Tests the SSH connection to the specified appliance. If the *appliance_ID* specifies a Data Collector or Message Collector, the **phonehome** command will test the SSH connection using the loopback address of the Data Collector or Message Collector and port 10022. If the appliance ID specifies a Database Server, the **phonehome** command will test the SSH connection using the public IP address of the Database Server and defined SSH port.
 - *appliance_ID*. Enter the numeric ID of the appliance. You can find this ID with the **phonehome status** command.
- **status**. Can be run on any appliance in the PhoneHome configuration. Displays the name and status of each currently defined PhoneHome appliance.
- **sync**. Run this command from the Data Collectors, Message Collectors, or secondary Database Server. Downloads the current configuration for PhoneHome from the Control Node Database Server to the Data Collector, Message Collector, and secondary Database Server.
- **token** *appliance_ID*. Run this command from the Control Node Database Server. This command creates a URL that allows the Data Collector(s), Message Collector(s), or secondary Database Server to log in to the Control Node Database Server, upload a public key to the Control Node Database Server, and download the configuration for PhoneHome from the Control Node Database Server.
 - *appliance_ID*. Enter the numeric ID of the Data Collector, Message Collector, or secondary Database Server. You can find this ID with the **phonehome status** command.
- **view** *appliance_id* **-json** *yes*. Run this command from the Control Node Database Server. Displays the name, type, loopback IP, port status, revision number, and SSH status of the Data Collector, Message Collector, or secondary Database Server specified in *appliance_ID*.
 - *appliance_ID*. Enter the numeric ID of the appliance that you want. You can find this ID with the **phonehome status** command.
 - **-json** *yes*. Displays output in json format.
- **wake** *appliance_id*. Run this command from the primary Database Server. Depending on the specified *appliance_ID*, stops and then restarts communication between the Database Server and the Data Collector, Message Collector, or secondary Database Server.
 - *appliance_ID*. Enter the numeric ID of the appliance that you want. You can find this ID with the **phonehome status** command.
- **watchdog** *option*. Run this command from the Data Collector, Message Collector, or secondary Database Server. The watchdog service runs automatically on each Data Collector, Message Collector, or secondary Database Server and checks the connection to the Control Node Database Server. If the connection is stale, the watchdog service automatically forces the Control Node Database Server to reconnect to the Data Collector, Message Collector, or secondary Database Server. The watchdog service can also detect configuration changes. If the PhoneHome configuration changes, the watchdog service will detect the changes and synchronize the configuration data on each device in the PhoneHome configuration.

NOTE: The *watchdog* and *autosync* services are not available for versions of the ScienceLogic platform *earlier than the 7.5.3 ISO*.

You can use this command to control the watchdog service. The options are:

- *start*. Starts the PhoneHome watchdog service.
- *stop*. Stops the PhoneHome watchdog service.
- *status*. Gets the status of the PhoneHome watchdog service.
- *view*. Displays the current settings for the watchdog service.
- *set -parameter value*. Sets the value of a parameter for the watchdog service. Parameters are:
 - *interval seconds*. Specify the interval, in seconds, at which to execute the watchdog service. The default value is "50".
 - *autosync (yes, no)*. Specifies whether or not you want the watchdog service to cause configuration data to be synchronized automatically at regular intervals.
 - *autoreconnect (yes, no)*. Specifies whether or not you want the watchdog service to reconnect stale connections automatically.
 - *state (enabled, disabled)*. Specifies whether or not the watchdog service is running.
 - *timeoutcount number*. Specifies the number of failed calls to the watchdog service before stopping and restarting the watchdog. The default value is "3".
 - *check (ssh, db, default)*. Specifies which port the watchdog service checks. The default value is "db".
- *run -verbose (yes, no)*. Manually starts the watchdog service if it is not already running.
- *-verbose (yes, no)*. Specifies whether or not to display verbose logging to standard output.

Troubleshooting the PhoneHome Configuration

Best Practices

Make all changes to the PhoneHome configuration on the Control Node. After making these changes, run the following command on each appliance in the PhoneHome configuration:

```
sudo phonehome sync
```

Basic Troubleshooting

Problem	Possible Cause	Diagnostics
Can't register a server or sync a server	Can't access the PhoneHome port on the Control Node	At the command line of the server that can't sync or register: <pre>nmap -p port_number IP_address_of_control_node</pre> For example: <pre>nmap -p 7705 71.197.6.197</pre>
Can't register a server or sync a server	Confirm that the PhoneHome port is open on the firewall on the Control Node	At the command line of the control node: <pre>iptables -nL</pre> You should see output that specifies that the port accepts connections. To open the port, run this command: <pre>sudo phonehome open-control-port</pre>
Forgot to copy the token for a server		<pre>phonehome token appliance_ID</pre>
Confirm that Data Collector(s) and/or Message Collector(s) are successfully configured for PhoneHome		At the command line of the control node: <pre>o netstat -an grep -i listen grep "127.0.0." grep 7707</pre> Output displays each Data Collector and Message Collector that is listening for PhoneHome communications.

Verifying the Control Node

For the PhoneHome configuration to perform successfully, each server in the configuration must use the same Control Node. To determine which Database Server is the Control Node, perform the following:

1. Either go to the console of the ScienceLogic appliance or use SSH to access a Database Server. Log in as "em7admin"
2. At the shell prompt, type the following:

```
sudo phonehome status
```

3. For the Control Node, you should see something that looks like this:

```
Phone Home Client configuration:
Config Revisions: Device: 0 Destinations: 7 Global: 8

Device Id   Type      State      Status      Forwards      Name
-----
19 collector Enabled disconnected Phone Home collector 19

Device Id   Type      State      Host      Port      Name
-----
17 database Enabled 10.64.68.31 7705 Phone Home database 17
18 database Enabled 10.64.68.32 7705 Phone Home database 18
```

- The Control Node displays "Device:0" in the output.
- The output for the control node does not include a URL.

4. Perform steps 1-3 on each additional Database Server in the PhoneHome Configuration. You should see something like this:

```
Phone Home Client configuration:
Config Revisions: Device: 4 Destinations: 7 Global: 8
Destinations:
Phone Home database 17 - 10.64.68.31:7705
Phone Home database 18 - 10.64.68.32:7705
URL: phonehome://2@10.64.68.31:7705/

Device Id   Type      State      Status      Forwards      Name
-----
19 collector Enabled disconnected Phone Home collector 19

Device Id   Type      State      Host      Port      Name
-----
18 database Enabled 10.64.68.32 7705 Phone Home database 18
17 database Enabled 10.64.68.31 7705 Phone Home database 17
```

- The URL for the secondary Database Server includes the IP address its control node.

5. Either go to the console of the ScienceLogic appliance or use SSH to access a Data Collector or Message Collector. Log in as "em7admin".
6. At the shell prompt, type the following:

```
sudo phonehome status
```

7. You should see something that looks like this:

```
Phone Home Client configuration:
Config Revisions: Device: 3 Destinations: 7 Global: 8
Destinations:
  Phone Home database 17 - 10.64.68.31:7705
  Phone Home database 18 - 10.64.68.32:7705
URL: phonehome://2@10.64.68.31:7705/
```

- The output for the Data Collector or Message Collector includes the text "Client Configuration" in the output.
- The URL for the Data Collector or Message Collector includes the IP address in its control node.

8. Perform steps 5-7 on each Data Collector and Message Collector in the PhoneHome Configuration.

To fix one or more secondary Database Servers that returns a different Control Node, you can perform the following:

1. On the Database Server that the secondary Database Server incorrectly identifies as the Control Node, either go to the console of the ScienceLogic appliance or use SSH to access the server. Log in as "em7admin". Type the following:

```
phonehome clear client
```

2. On the Database Server that is the correct Control Node, perform steps 8-12 in [Configuring the Control Node Database Server](#). These are the steps that define the secondary Database Server, including saving the token and saving the new configuration.
3. On the secondary Database Server that returns the incorrect control node, perform the steps in [Configuring the Secondary Database Server for High Availability and Disaster Recovery](#).

To fix one or more Data Collectors or Message Collectors that return a different Control Node, you can perform the following:

1. On the Database Server that the Data Collectors or Message Collectors incorrectly identifies showing as the Control Node (the incorrect Control Node), either go to the console of the ScienceLogic appliance or use SSH to access the server. Log in as "em7admin". Enter the following:

```
phonehome clear client
```

2. On the Database Server that is the correct Control Node, perform steps 8-12 in [Configuring the Control Node Database Server](#). These are the steps that define the Data Collectors or Message Collectors, including saving the token and saving the new configuration.
3. On the Data Collectors or Message Collectors that returned a different Control Node, perform the steps in [Configuring the Data Collector and Message Collector for PhoneHome](#).

Deploying ScienceLogic Appliances in the Amazon Cloud

Introduction

This chapter describes the process of setting up a ScienceLogic appliance on an Amazon Web Services EC2 instance. An instance is a virtual server that resides in the AWS cloud.

This chapter describes:

<i>Prerequisites</i>	82
<i>What is an AWS AMI?</i>	82
<i>What are the ScienceLogic AMIs?</i>	83
<i>Instance Specifications</i>	83
<i>Deploying a ScienceLogic System in AWS</i>	83
<i>Getting the ScienceLogic AMI</i>	83
<i>Launching the New Instance</i>	86
<i>Security Rules for Each Appliance Type</i>	94
<i>All-In-One Appliance</i>	94
<i>Database Server</i>	97
<i>Administration Portal</i>	99
<i>Data Collector</i>	101
<i>Message Collector</i>	103
<i>Additional Configuration Steps</i>	105
<i>Assigning an EIP to the New Instance</i>	106

Accessing the Appliance Using SSH	109
<i>Gathering Information Required for Accessing the Appliance Using SSH</i>	109
<i>Configuring SSH</i>	109
<i>UNIX and LINUX Users</i>	110
<i>Windows Users</i>	110
Web Configuration Tool	110
Rebooting Data Collectors and Message Collectors	110

NOTE: For more information about monitoring Amazon Web Services in the ScienceLogic platform, see the *Monitoring Amazon Web Services* manual.

Prerequisites

To perform the steps in this chapter, you will need:

- Basic knowledge of Amazon Web Services principles and terminology
- An Amazon Web Services account
- Basic knowledge of:
 - The AWS Management Console
 - Amazon EC2
 - Virtualization
 - IP Networking
- Secure Shell client software:
 - ssh command on Linux/Unix
 - PuTTY (or similar) application on Windows
 - PuTTYgen (required to convert AWS key to PuTTY format)

What is an AWS AMI?

An instance is a virtual server that resides in the AWS cloud. An Amazon Machine Image (AMI) is the collection of files and information that AWS uses to create an instance. A single AMI can launch multiple instances.

For details on AMIs, see <http://docs.aws.amazon.com/AWSEC2/latest/UserGuide/AMIs.html>.

What are the ScienceLogic AMIs?

The ScienceLogic AMIs are defined by ScienceLogic. ScienceLogic has created an AMI for each type of ScienceLogic appliance. You can use a ScienceLogic AMI to create Elastic Compute Cloud (EC2) instances for each type of ScienceLogic appliance.

NOTE: Elastic Compute Cloud (EC2) instances are virtual servers that come in a variety of configurations and can be easily changed as your computing needs change. For more information on EC2, see <http://docs.aws.amazon.com/AWSEC2/latest/UserGuide/concepts.html>.

The ScienceLogic AMIs are private and are for ScienceLogic customers only. After you collect specific information about your AWS account, you can send a request (and the collected information) to ScienceLogic, and ScienceLogic will share the ScienceLogic AMIs with you.

Instance Specifications

For details about requirements and specifications for each ScienceLogic appliance, see the Customer Portal: <https://portal.sciencelogic.com/portal/system-requirements/aws>

Deploying a ScienceLogic System in AWS

To deploy a distributed ScienceLogic system on AWS instances, create appliances in this order:

1. Database Server
2. Administration Portal (if applicable)
3. Data Collectors
4. Message Collectors (if applicable)

Getting the ScienceLogic AMI

To get access to the ScienceLogic AMI:

1. Open a browser session and go to:

`https://portal.sciencelogic.com/portal/images`

2. Find the platform version that you want to download. Click on its name.
3. At the bottom of the **ScienceLogic Platform Version** page, find a list of AMIs. Click on the ScienceLogic appliance type for which you want an AMI.

- In the **Request Amazon AMI** page, enter your AWS Account ID. For details on finding your account ID, see <https://docs.aws.amazon.com/general/latest/gr/acct-identifiers.html>.
- Click the **[Submit AMI Request]** button. Repeat steps 1-5 for each type of ScienceLogic appliance you want to install on AWS.
- ScienceLogic Customer Support will send you an email confirming that they have shared the ScienceLogic AMI with your AWS account.
- To view the ScienceLogic AMIs in your AWS account, go to the **AWS Management Console** page. Under the heading **Compute**, click **[EC2]**.

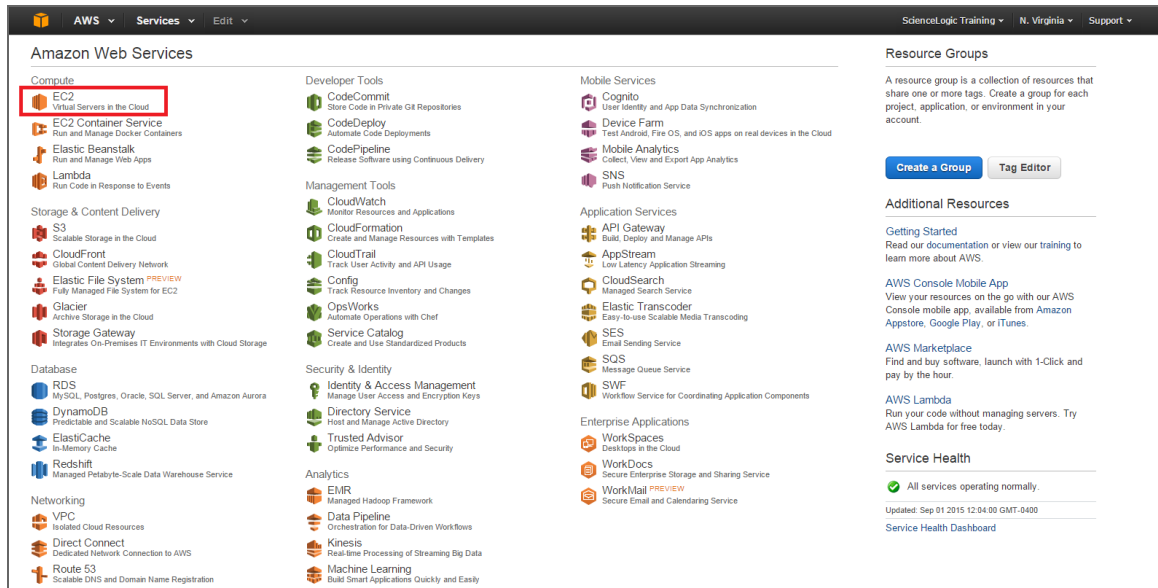

- In the **EC2 Dashboard** page, go to the left navigation bar. Under the heading **Images**, click **[AMIs]**.
- In the main pane, under **Filters**, click **[Owned by me]** and then select **Private images**.

10. You should see AMIs with names that begin with "EM7" and end with the current release number for the ScienceLogic platform. You should see an AMI for each type of ScienceLogic appliance.

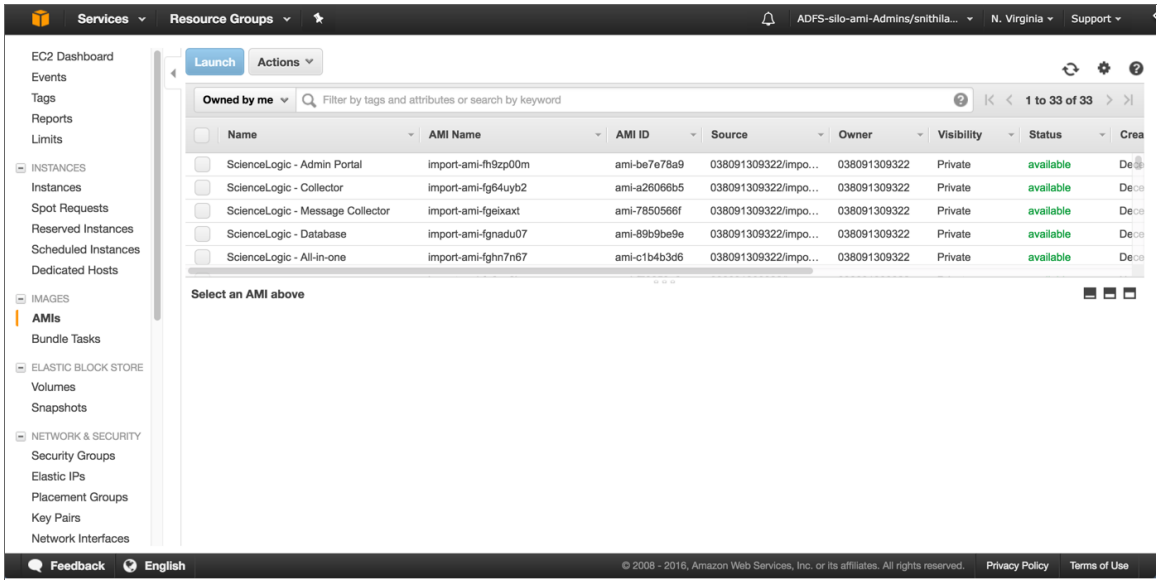

11. If you do not see AMIs with names that begin with "EM7", your EC2 Dashboard might have a default region that does not match the region for the ScienceLogic AMIs. To change the current region in the EC2 dashboard, click the region pull-down in the upper right and choose another region. Do this until you find the ScienceLogic AMIs.

NOTE: A region is a geographic location. AWS has data centers that include multiple regions. You can specify that an instance reside in a specific region. For more details on regions, see <http://docs.aws.amazon.com/AWSEC2/latest/UserGuide/using-regions-availability-zones.html>.

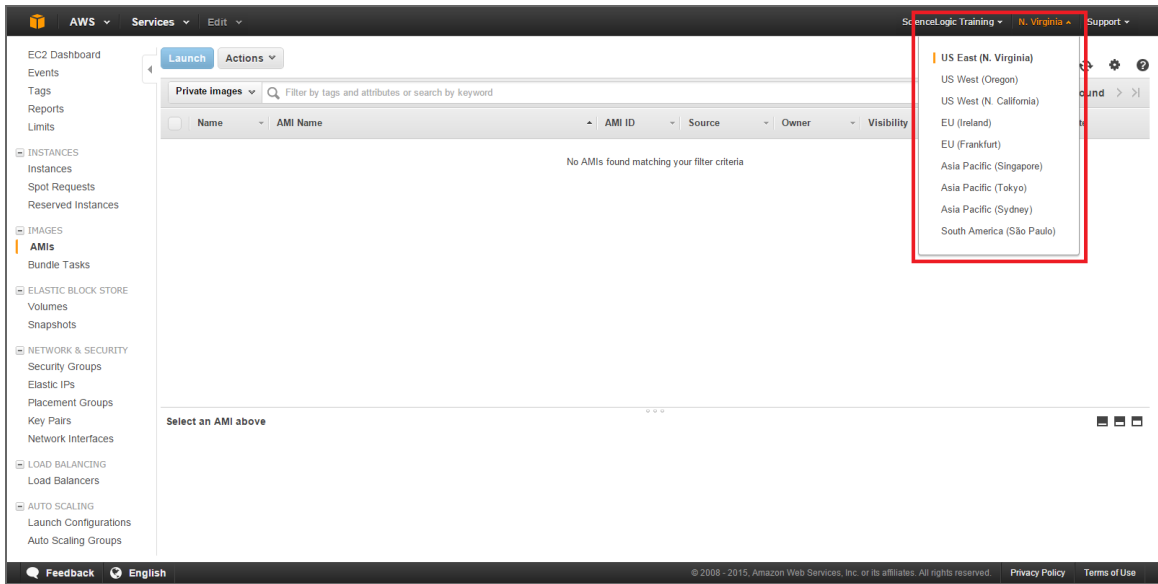

Launching the New Instance

To complete the steps listed in this chapter, you must have [received the ScienceLogic AMIs](#).

This chapter assumes that you will launch each new EC2 instance into a VPC subnet with a primary IP address that is static and private.

NOTE: For more information on VPCs and VPC subnets, see http://docs.aws.amazon.com/AmazonVPC/latest/UserGuide/VPC_Introduction.html.

For details about the recommended instance type for each ScienceLogic appliance, see the Customer Portal: <https://portal.sciencelogic.com/portal/system-requirements/aws>

You can use multiple AWS instances to create a distributed ScienceLogic system. For each instance, you must specify the correct instance type, storage size, and security rules. All these parameters are described in this chapter.

To launch the new EC2 instance from the ScienceLogic AMI:

1. Go to the [EC2 Dashboard](#):

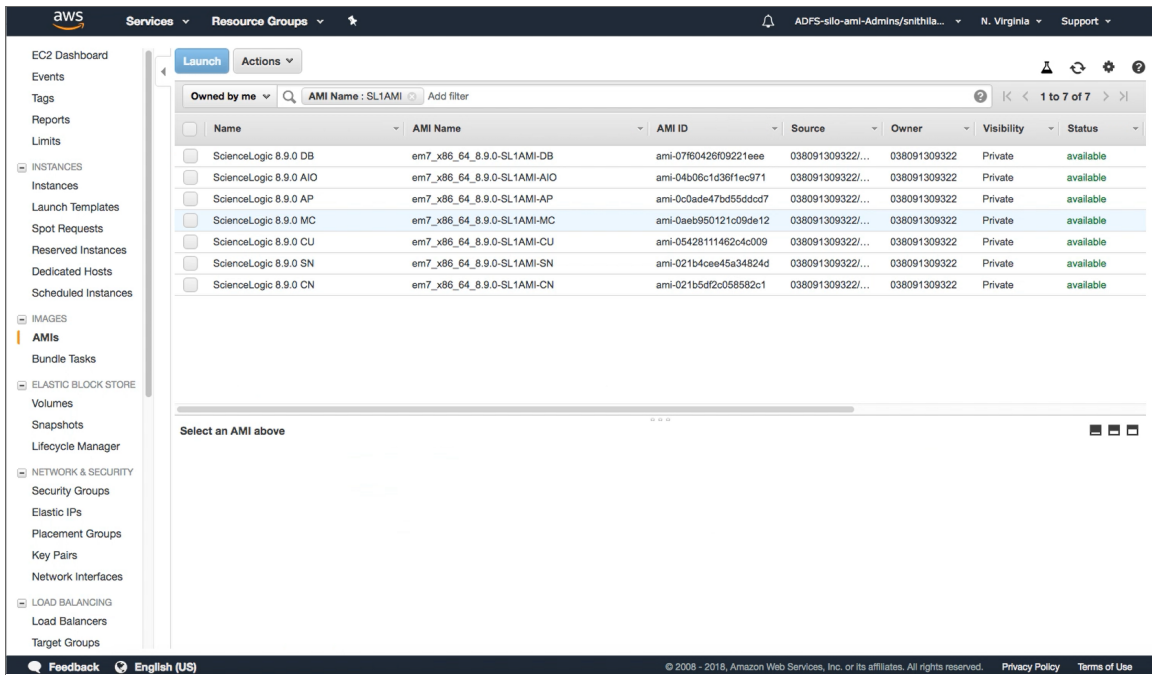

2. Select the ScienceLogic AMI that matches the ScienceLogic appliance you want to create. Click the **[Launch]** button.

NOTE: In the 7.8 version of the ScienceLogic platform, ScienceLogic published a single AMI instance that created all types of ScienceLogic appliances. In version 8.2 and later of the ScienceLogic platform, ScienceLogic published multiple AMI instances, one for each type of ScienceLogic appliance.

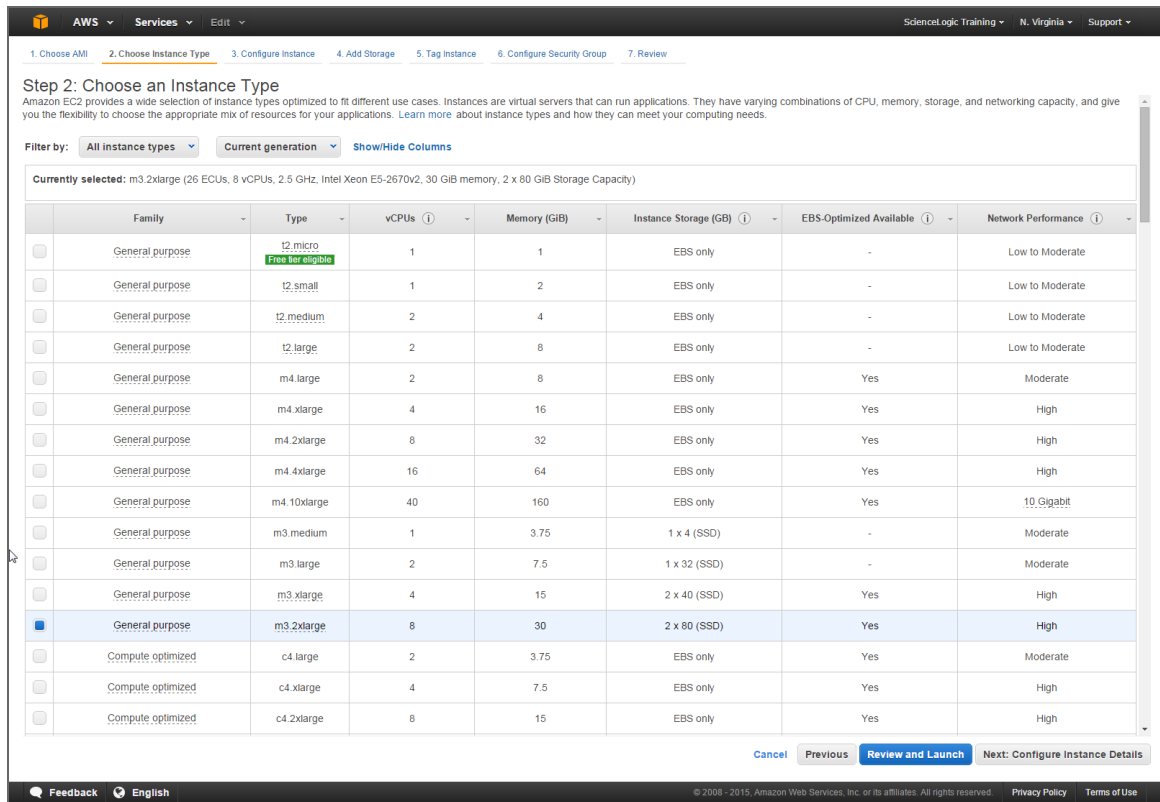

3. In the **Choose Instance Type** page, choose the instance type recommended for the AMI. Choose the size and type that fulfills your needs. For information on virtual machine requirements for the ScienceLogic platform, see the section on [Virtual Machine Specifications](#).

NOTE: For details about the recommended instance type for each ScienceLogic appliance, see the Customer Portal: <https://portal.sciencelogic.com/portal/system-requirements/aws>

NOTE: ScienceLogic recommends that you not use the Instance Types m3.large, c3.xlarge, or c4.xlarge. These instance types are limited to 3.8 GiB of RAM, instead of the standard 7.5 GiB of RAM provided on other instance types.

4. Click the [Next: Configure Instance Details] button.

The screenshot shows the AWS Management Console interface for configuring an EC2 instance. The page is titled "Step 3: Configure Instance Details" and includes a progress bar at the top with steps: 1. Choose AMI, 2. Choose Instance Type, 3. Configure Instance Details (current), 4. Add Storage, 5. Tag Instance, 6. Configure Security Group, and 7. Review. Below the title, there is a brief instruction: "Configure the instance to suit your requirements. You can launch multiple instances from the same AMI, request Spot Instances to take advantage of the lower pricing, assign an access management role to the instance, and more." The configuration options are as follows:

- Number of instances:** Input field with "1" entered.
- Purchasing option:** Radio button for "Request Spot Instances" is selected.
- Network:** Dropdown menu showing "vpc-9b5009fe (172.31.0.0/16) (default)" with a "Create new VPC" link.
- Subnet:** Dropdown menu showing "subnet-44058c1d(172.31.16.0/20) | Default in us-e." with a "Create new subnet" link and "4067 IP Addresses available" text.
- Auto-assign Public IP:** Dropdown menu showing "Use subnet setting (Enable)".
- IAM role:** Dropdown menu showing "None" with a "Create new IAM role" link.
- Shutdown behavior:** Dropdown menu showing "Stop".
- Enable termination protection:** Radio button for "Protect against accidental termination" is selected.
- Monitoring:** Radio button for "Enable CloudWatch detailed monitoring" is selected, with "Additional charges apply." text below.
- EBS-optimized instance:** Radio button for "Launch as EBS-optimized instance" is selected, with "Additional charges apply." text below.
- Tenancy:** Dropdown menu showing "Shared tenancy (multi-tenant hardware)" with "Additional charges will apply for dedicated tenancy." text below.

At the bottom right, there are buttons for "Cancel", "Previous", "Review and Launch" (highlighted), and "Next: Add Storage".

5. In the **Configure Instance Details** page, define the following:

- **Number of Instances.** Enter "1".
- **Request Spot Instances.** Do not select.
- **Network.** For VPC-enabled accounts, specify the network where the instance will reside. If you are unsure of the network, accept the default.
- **Subnet.** For VPC-enabled accounts, specify the subnet where the instance will reside. If you are unsure of the subnet, accept the default.
- **Auto-assign Public IP.** If you select *Enable*, AWS will assign an IP address from the public pool to this instance. If you select *Disable*, you must assign an [Elastic IP Address \(EIP\)](#) to the instance.

NOTE: If you select *Enable* in the **Auto-assign Public IP** field, the IP address will change each time the instance is stopped or terminated. For All-In-One Appliances and for Administration Portals, you might want to use an Elastic IP address (EIP), which is a persistent IP address. See the section on [Elastic IP Addresses \(EIP\)](#) for details.

NOTE: For more information on Elastic IP Addresses, see <http://docs.aws.amazon.com/AWSEC2/latest/UserGuide/elastic-ip-addresses-eip.html>.

- **IAM role.** If your organization uses IAM roles, select the appropriate role.
- **Shutdown behavior.** Select *Stop*.

- **Enable termination protection.** Selecting this checkbox is not required. Configure this checkbox according to your organization's procedures.
- **Monitoring.** Do not select this checkbox.
- **EBS-optimized instance.** Do not select this checkbox.
- **Tenancy.** Select *Shared tenancy (multi-tenant hardware)*.

6. Click the **[Next: Add Storage]** button.

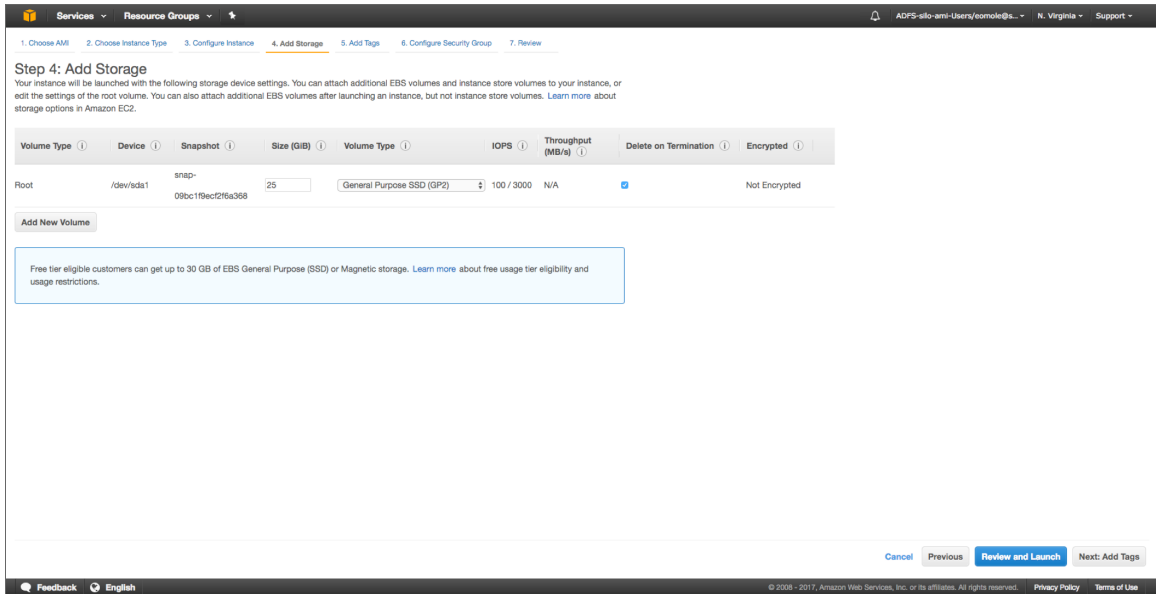

7. In the **Add Storage** page, select the checkbox in the **Delete on Termination** column.

8. In the **Add Storage** page, increase the size of the `/dev/sda1` partition as follows:

ScienceLogic Appliance	Type	>Device	Size in GB
Administration Portal	Instance Store	/dev/sda1	85
Message Collector without ScienceLogic Agent	Instance Store	/dev/sda1	85
Message Collector with ScienceLogic Agent	Instance Store	/dev/sda1	85
Database Server	EBS	/dev/sda1	105
All-In-One Appliance	EBSNVMe SSD	/dev/sda1	105
Data Collector	Instance Store	/dev/sda1	85

NOTE: The `/dev/sda1` partition will contain the database.

9. Click the **[Next: Tag Instance]** button.

Step 5: Tag Instance

A tag consists of a case-sensitive key-value pair. For example, you could define a tag with key = Name and value = Webserver. [Learn more](#) about tagging your Amazon EC2 resources.

Key (127 characters maximum)	Value (255 characters maximum)
Name	ScienceLogic AIO

Create Tag (Up to 10 tags maximum)

Cancel Previous **Review and Launch** Next: Configure Security Group

10. In the **Tag Instance** page, assign a descriptive tag to this instance. For example, you could enter "Name" in the **Key** field and "ScienceLogic AIO" in the **Value** field. This is optional.

NOTE: For more information on tags, see http://docs.aws.amazon.com/AWSEC2/latest/UserGuide/Using_Tags.html.

11. Click the **[Next: Configure Security Group]** button.

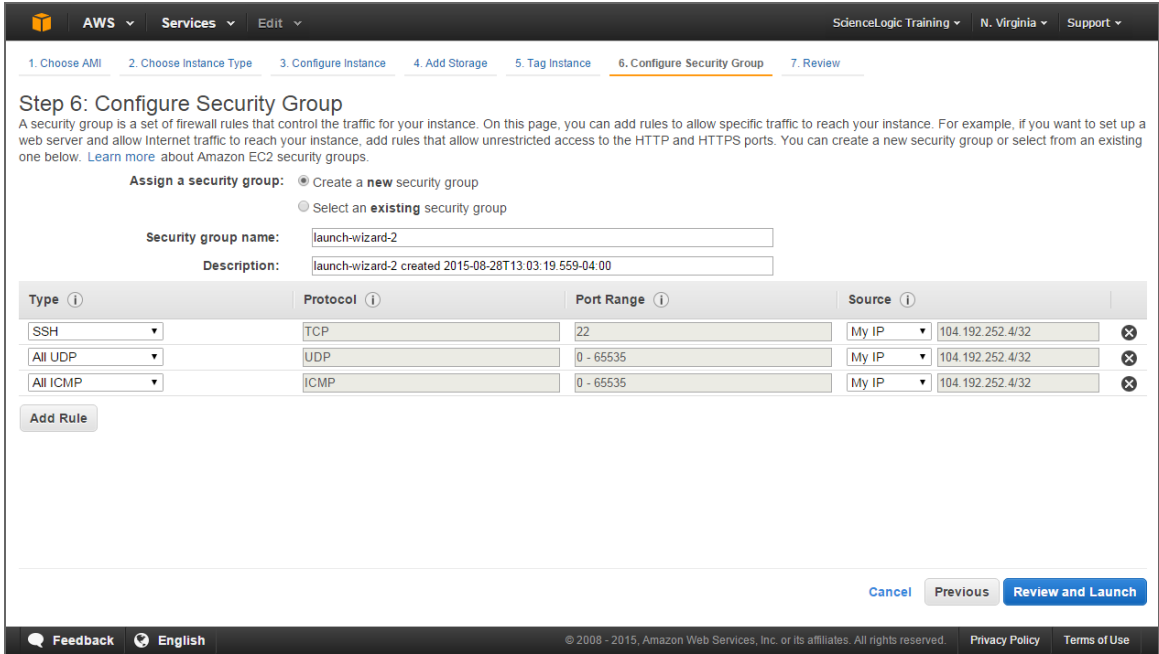

12. A security group is a reusable set of firewall rules. In the **Configure Security Group** page, do the following:

- **Assign a security group**. Select *Create a new security group*.
- **Security group name**. Enter a name or accept the default name.
- **Description**. Accept the default value in this field.

13. Use the **following tables** to create security rules for each type of ScienceLogic appliance. After completing each row, click the **[Add Rule]** button.

14. Click the **[Review and Launch]** button and review the details of the new instance. Fix any problems to meet the requirements of your organization.

15. Click the **[Launch]** button.

16. Amazon EC2 instances use public-key cryptography for authentication. Select **create a new key pair now**. You can enter a name for the private key. AWS will store the public key on its servers and automatically download the file that contains the private key to your browser. The private key is stored in a file that ends in .pem. You will need this file again when you **configure SSH** access to your AWS instances.

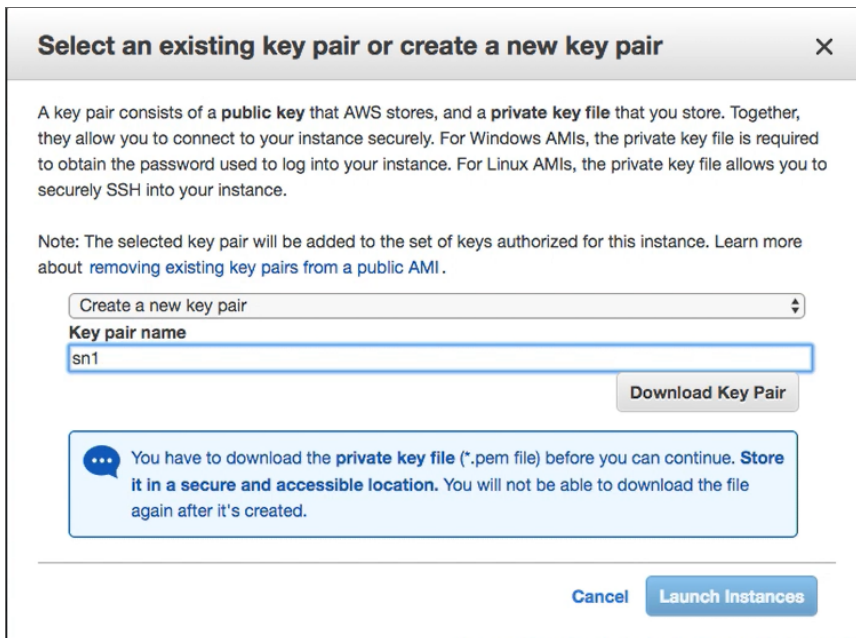

16. Amazon EC2 instances use public-key cryptography for authentication.

- Select **create a new key pair now**.
- **Key pair name**. Enter a name for the private key.
- **Download Key Pair**. AWS will store the public key on its servers and automatically download the file that contains the private key to your browser. The private key is stored in a file that ends in `.pem`. You will need this file again when you [configure SSH](#) access to your AWS instances.

NOTE: Do not select an existing key unless you have previously downloaded and saved the key. You cannot retrieve an existing key a second time.

17. Click the **[Launch Instances]** button.
18. The **Launch Status** page displays the status of the new instance.
19. While the Launch runs in the background, go to the **Instances** page and provide a value in the **Name** field.
20. When the instance launch has completed, click the **[View Instances]** button to see your new instance.

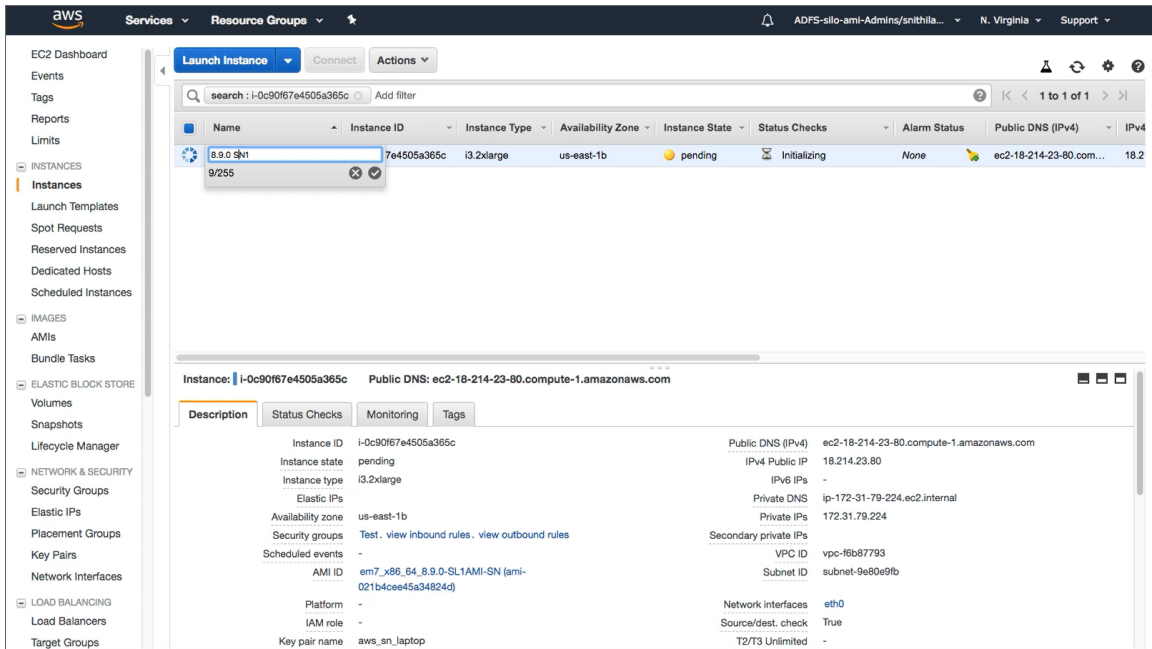

20. When the instance launch has completed, click the **[View Instances]** button to see your new instance.
21. For all nodes, continue to the steps listed in [Additional Configuration Steps](#).

Security Rules for Each Appliance Type

All-In-One Appliance

Type	Protocol	Port Range	Source	Description
SSH (edit the default SSH rule)	TCP	22	<p>If you will always log in from a single IP address, select <i>My IP</i>.</p> <p>If you will log in to the instance from multiple IP addresses, enter those IP addresses, separated by commas, in this field.</p> <p>Configure this list according to your requirements, your AWS configuration, and your security rules.</p>	SSH. For SSH sessions from the user workstation to the appliance. This is necessary to start the installation wizard.

Type	Protocol	Port Range	Source	Description
HTTP	TCP	80	<p>If you will always log in from a single IP address, select <i>My IP</i>.</p> <p>If you will log in to the instance from multiple IP addresses, enter those IP addresses, separated by commas, in this field.</p> <p>Configure this list according to your requirements, your AWS configuration, and your security rules.</p>	HTTP from browser session on user workstation.
HTTPS	TCP	443	<p>If you will always log in from a single IP address, select <i>My IP</i>.</p> <p>If you will log in to the instance from multiple IP addresses, enter those IP addresses, separated by commas, in this field.</p> <p>Configure this list according to your requirements, your AWS configuration, and your security rules.</p>	HTTPS from browser session on user workstation.
Custom TCP Rule	TCP	7700	<p>If you will always log in from a single IP address, select <i>My IP</i>.</p> <p>If you will log in to the instance from multiple IP addresses, enter those IP addresses, separated by commas, in this field.</p> <p>Configure this list according to your requirements, your AWS configuration, and your security rules.</p>	ScienceLogic Web Configurator. Configuration Utility from browser session on user workstation. This is necessary to license the appliance.

Type	Protocol	Port Range	Source	Description
Custom UDP Rule	UDP	162	Specify a list of IP addresses for all managed devices from which you want to receive SNMP traps. Configure this list according to your requirements, your AWS configuration, and your security rules.	SNMP Traps. Necessary to receive SNMP traps from managed devices.
Custom UDP Rule	UDP	514	Specify a list of IP addresses for all managed devices from which you want to receive Syslog messages. Configure this list according to your requirements, your AWS configuration, and your security rules.	Syslog messages. Necessary to receive syslog messages from managed devices.
SMTP	TCP	25	Specify a list of IP addresses for all managed devices from which you want to receive email messages. Configure this list according to your requirements, your AWS configuration, and your security rules.	Necessary to receive inbound email for tickets, events, and email round-trip monitoring.
Custom TCP Rule	TCP	123	Enter the IP address of the NTP server. Configure this list according to your requirements, your AWS configuration, and your security rules.	NTP. Communication between the All-In-One Appliance and configured NTP server.

Database Server

Type	Protocol	Port Range	Source	Description
SSH (edit the default SSH rule)	TCP	22	<p>If you will always log in from a single IP address, select <i>My IP</i>.</p> <p>If you will log in to the instance from multiple IP addresses, enter those IP addresses, separated by commas, in this field.</p> <p>Configure this list according to your requirements, your AWS configuration, and your security rules.</p>	SSH. For ssh sessions from user workstation to the appliance. This is necessary to start the installation wizard.
SMTP	TCP	25	<p>Specify a list of IP addresses for all managed devices from which you want to receive email messages.</p> <p>Configure this list according to your requirements, your AWS configuration, and your security rules.</p>	Necessary to receive inbound email for tickets, events, and email round-trip monitoring.
HTTP NOTE: Required only if you are using the Administration Portal on the Database	TCP	80	<p>If you will always log in from a single IP address, select <i>My IP</i>.</p> <p>If you will log in to the instance from multiple IP addresses, enter those IP addresses, separated by commas, in this field.</p> <p>Configure this list according to your requirements, your AWS configuration, and your security rules.</p>	HTTP from browser session on user workstation.



Type	Protocol	Port Range	Source	Description
Custom TCP Rule	TCP	123	<p>Enter the IP address of the NTP server.</p> <p>Configure this list according to your requirements, your AWS configuration, and your security rules.</p>	NTP. Communication between the All-In-One Appliance and configured NTP server.
Custom UDP Rule	UDP	161	<p>Specify an IP address for each Data Collector that you will allow to can collect SNMP information about the Database Server.</p> <p>Configure this list according to your requirements, your AWS configuration, and your security rules.</p>	SNMP Agent. Allows SNMP information about the Database Server to be collected by the ScienceLogic platform.
<p>HTTPS</p> <p>NOTE: Required only if you are using the Administration Portal on the Database</p>	TCP	443	<p>If you will always log in from a single IP address, select <i>My IP</i>.</p> <p>If you will log in to the instance from multiple IP addresses, enter those IP addresses, separated by commas, in this field.</p> <p>Configure this list according to your requirements, your AWS configuration, and your security rules.</p>	HTTPS from browser session on user workstation.
Custom TCP Rule	TCP	7700	<p>If you will always log in from a single IP address, select <i>My IP</i>.</p> <p>If you will log in to the instance from multiple IP addresses, enter those IP addresses, separated by commas, in this field.</p> <p>Configure this list according to your requirements, your AWS configuration, and your security rules.</p>	ScienceLogic Web Configurator. Configuration Utility from browser session on user workstation. This is necessary to license the appliance.

Type	Protocol	Port Range	Source	Description
Custom TCP Rule	TCP	7706	Specify an IP address for each Data Collector that you will allow to collect SNMP information about the Database Server. Configure this list according to your requirements, your AWS configuration, and your security rules.	MySQL. Communication from Administration Portal
Custom TCP Rule	TCP	8008	If you will always log in from a single IP address, select <i>My IP</i> . If you will log in to the instance from multiple IP addresses, enter those IP addresses, separated by commas, in this field. Configure this list according to your requirements, your AWS configuration, and your security rules.	Administrative Web Interface (PHPMyAdmin) from browser session on user workstation

Administration Portal

Type	Protocol	Port Range	Source	Description
SSH (edit the default SSH rule)	TCP	22	If you will always log in from a single IP address, select <i>My IP</i> . If you will log in to the instance from multiple IP addresses, enter those IP addresses, separated by commas, in this field. Configure this list according to your requirements, your AWS configuration, and your security rules.	SSH. For ssh sessions from user workstation to the appliance. This is necessary to start the installation wizard.

Type	Protocol	Port Range	Source	Description
HTTP	TCP	80	<p>If you will always log in from a single IP address, select <i>My IP</i>.</p> <p>If you will log in to the instance from multiple IP addresses, enter those IP addresses, separated by commas, in this field.</p> <p>Configure this list according to your requirements, your AWS configuration, and your security rules.</p>	HTTP from browser session on user workstation.
HTTPS	TCP	443	<p>If you will always log in from a single IP address, select <i>My IP</i>.</p> <p>If you will log in to the instance from multiple IP addresses, enter those IP addresses, separated by commas, in this field.</p> <p>Configure this list according to your requirements, your AWS configuration, and your security rules.</p>	HTTPS from browser session on user workstation.
Custom TCP Rule	TCP	123	<p>Enter the IP address of the NTP server.</p> <p>Configure this list according to your requirements, your AWS configuration, and your security rules.</p>	NTP. Communication between the Administration Portal and configured NTP server.

Type	Protocol	Port Range	Source	Description
Custom TCP Rule	TCP	7700	<p>If you will always log in from a single IP address, select <i>My IP</i>.</p> <p>If you will log in to the instance from multiple IP addresses, enter those IP addresses, separated by commas, in this field.</p> <p>Configure this list according to your requirements, your AWS configuration, and your security rules.</p>	ScienceLogic Web Configurator. Configuration Utility from browser session on user workstation. This is necessary to license the appliance.
Custom UDP Rule	UDP	161	<p>Specify an IP address for each Data Collector that you will allow to can collect SNMP information about the Administration Portal.</p> <p>Configure this list according to your requirements, your AWS configuration, and your security rules.</p>	SNMP Agent. Allows SNMP information about the Administration Portal to be collected by the ScienceLogic platform.

Data Collector

Type	Protocol	Port Range	Source	Description
SSH (edit the default SSH rule)	TCP	22	<p>If you will always log in from a single IP address, select <i>My IP</i>.</p> <p>If you will log in to the instance from multiple IP addresses, enter those IP addresses, separated by commas, in this field.</p> <p>Configure this list according to your requirements, your AWS configuration, and your security rules.</p>	SSH. For ssh sessions from user workstation to the appliance. This is necessary to start the installation wizard.



Type	Protocol	Port Range	Source	Description
Custom TCP Rule	TCP	123	<p>Enter the IP address of the NTP server.</p> <p>Configure this list according to your requirements, your AWS configuration, and your security rules.</p>	NTP. Communication between the Data Collector and configured NTP server.
Custom UDP Rule	UDP	161	<p>Specify an IP address for each Data Collector that you will allow to collect SNMP information about this Data Collector.</p> <p>Configure this list according to your requirements, your AWS configuration, and your security rules.</p>	SNMP Agent. Allows SNMP information about the Data Collector to be collected by the ScienceLogic platform.
Custom UDP Rule	UDP	162	<p>Specify a list of IP addresses for all managed devices from which you want to receive SNMP traps.</p> <p>Configure this list according to your requirements, your AWS configuration, and your security rules.</p>	SNMP Traps. Necessary to receive SNMP traps from managed devices.
Custom UDP Rule	UDP	514	<p>Specify a list of IP addresses for all managed devices from which you want to receive Syslog messages.</p> <p>Configure this list according to your requirements, your AWS configuration, and your security rules.</p>	Syslog messages. Necessary to receive syslog messages from managed devices.

Type	Protocol	Port Range	Source	Description
Custom TCP Rule	TCP	7700	<p>If you will always log in from a single IP address, select <i>My IP</i>.</p> <p>If you will log in to the instance from multiple IP addresses, enter those IP addresses, separated by commas, in this field.</p> <p>Configure this list according to your requirements, your AWS configuration, and your security rules.</p>	ScienceLogic Web Configurator. Configuration Utility from browser session on user workstation. This is necessary to license the appliance.
Custom TCP Rule	TCP	7707	<p>Specify the IP address of the Database Server that you want to retrieve data from the Data Collector.</p> <p>Configure this list according to your requirements, your AWS configuration, and your security rules.</p>	Data Pull. Allows the Database Server to retrieve data from the Data Collector

Message Collector

Type	Protocol	Port Range	Source	Description
SSH (edit the default SSH rule)	TCP	22	<p>If you will always log in from a single IP address, select <i>My IP</i>.</p> <p>If you will log in to the instance from multiple IP addresses, enter those IP addresses, separated by commas, in this field.</p> <p>Configure this list according to your requirements, your AWS configuration, and your security rules.</p>	SSH. For ssh sessions from user workstation to the appliance. This is necessary to start the installation wizard.



Type	Protocol	Port Range	Source	Description
Custom TCP Rule	TCP	123	<p>Enter the IP address of the NTP server.</p> <p>Configure this list according to your requirements, your AWS configuration, and your security rules.</p>	NTP. Communication between the Message Collector and configured NTP server.
Custom UDP Rule	UDP	161	<p>Specify an IP address for each Data Collector that you will allow to collect SNMP information about this Message Collector.</p> <p>Configure this list according to your requirements, your AWS configuration, and your security rules.</p>	SNMP Agent. Allows SNMP information about the Message Collector to be collected by the ScienceLogic platform.
Custom UDP Rule	UDP	162	<p>Specify a list of IP addresses for all managed devices from which you want to receive SNMP traps.</p> <p>Configure this list according to your requirements, your AWS configuration, and your security rules.</p>	SNMP Traps. Necessary to receive SNMP traps from managed devices.
Custom UDP Rule	UDP	514	<p>Specify a list of IP addresses for all managed devices from which you want to receive Syslog messages.</p> <p>Configure this list according to your requirements, your AWS configuration, and your security rules.</p>	Syslog messages. Necessary to receive syslog messages from managed devices.

Type	Protocol	Port Range	Source	Description
Custom TCP Rule	TCP	7700	<p>If you will always log in from a single IP address, select <i>My IP</i>.</p> <p>If you will log in to the instance from multiple IP addresses, enter those IP addresses, separated by commas, in this field.</p> <p>Configure this list according to your requirements, your AWS configuration, and your security rules.</p>	ScienceLogic Web Configurator. Configuration Utility from browser session on user workstation. This is necessary to license the appliance.
Custom TCP Rule	TCP	7707	<p>Specify the IP address of the Database Server that you want to retrieve data from the Message Collector.</p> <p>Configure this list according to your requirements, your AWS configuration, and your security rules.</p>	Data Pull. Allows the Database Server to retrieve data from the Message Collector.

Additional Configuration Steps

After the instance is successfully launched, perform these additional steps to complete configuration:

- For instances of the **Database Server** or **All-In-One Appliance**:
 - [Assigning an EIP to the instance](#) (optional step)
 - [Accessing the Appliance Using SSH](#)
 - [Licensing the instance in the Web Configuration Tool](#)
- For instances of the **Administration Portal**:
 - [Assigning an EIP to the instance](#) (optional step)
 - [Accessing the Appliance Using SSH](#)
 - [Configuring the instance in the Web Configuration Tool](#)
- For instances of the **Data Collector and Message Collector**:

- [Assigning an EIP to the instance](#) (optional step)
- [Accessing the Appliance Using SSH](#)
- [Configuring the instance in the Web Configuration Tool](#)
- [Rebooting Data Collectors and Message Collectors](#)

Assigning an EIP to the New Instance

This chapter assumes you have already [received the ScienceLogic AMI](#) and [created an EC2 instance](#) based on the ScienceLogic AMI.

AWS can assign a public-facing IP address to your new instance. However, the IP address will change each time the instance is stopped or terminated. If you will be accessing an All-In-One Appliance or an Administration Portal appliance from the internet, ScienceLogic recommends you use an Elastic IP address (EIP).

An EIP is a permanent static address that belongs to an account (not an instance) and can be reused. An EIP address is required only if you want the public IP address to remain constant. When you assign an EIP to an instance, the instance still retains its private IP address in its VPC.

If you use an AWS VPN to access the All-In-One Appliance or Administration Portal appliance, that is you can access the All-In-One Appliance or Administration Portal appliance only through your corporate network, you do not have to assign an EIP to the All-In-One Appliance or Administration Portal appliance .

NOTE: For more information on Elastic IP, see <http://docs.aws.amazon.com/AWSEC2/latest/UserGuide/elastic-ip-addresses-eip.html>

NOTE: AWS accounts are limited five Elastic IP addresses.

To assign an EIP to your new instance:

1. Go to the **EC2 Dashboard**:

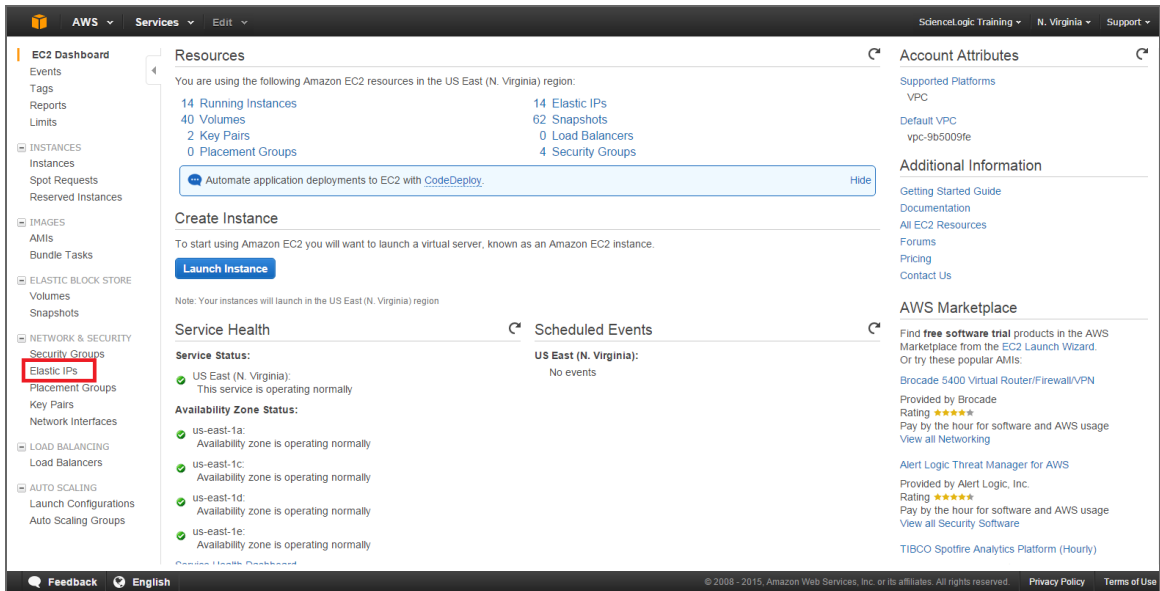

- In the left navigation pane, under the **Network & Security** heading, click **[Elastic IPs]**.

2. In the **Allocate New Address** page:

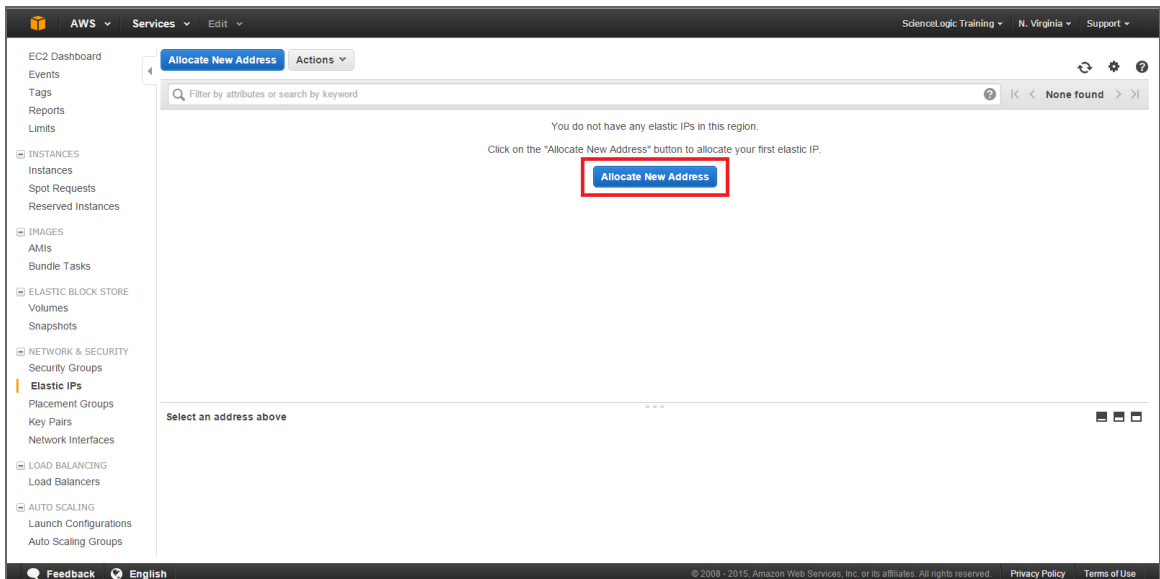

- Click the **[Allocate New Address]** button and then click the **[Yes, Allocate]** button.



3. In the **Allocate New Address** page:

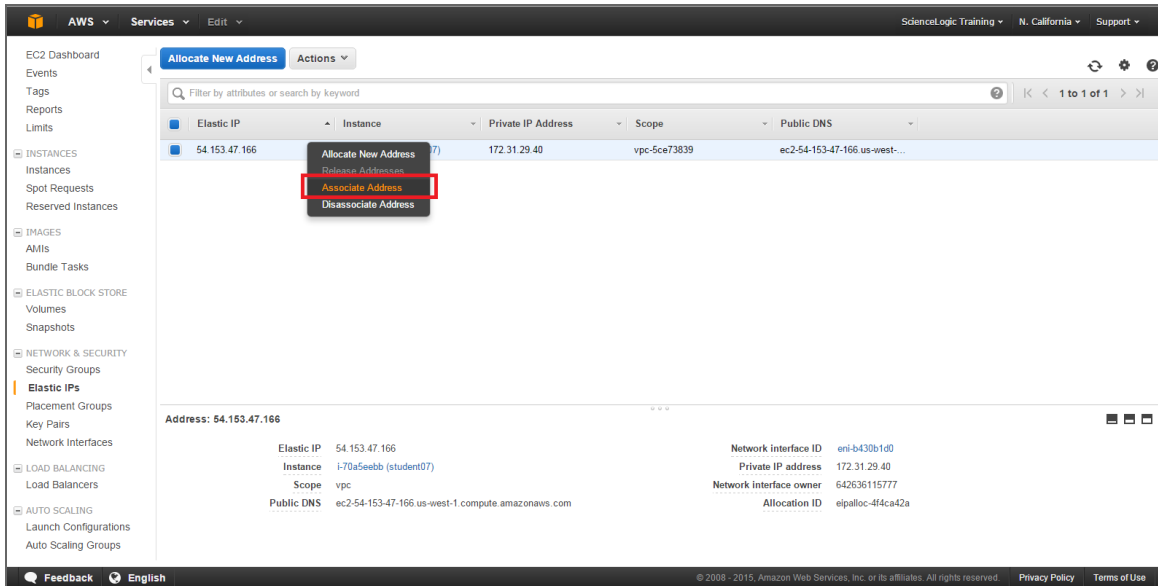

- Right-click the new address and select **Associate Address** from the drop-down menu.

4. In the **Associate Address** modal page:

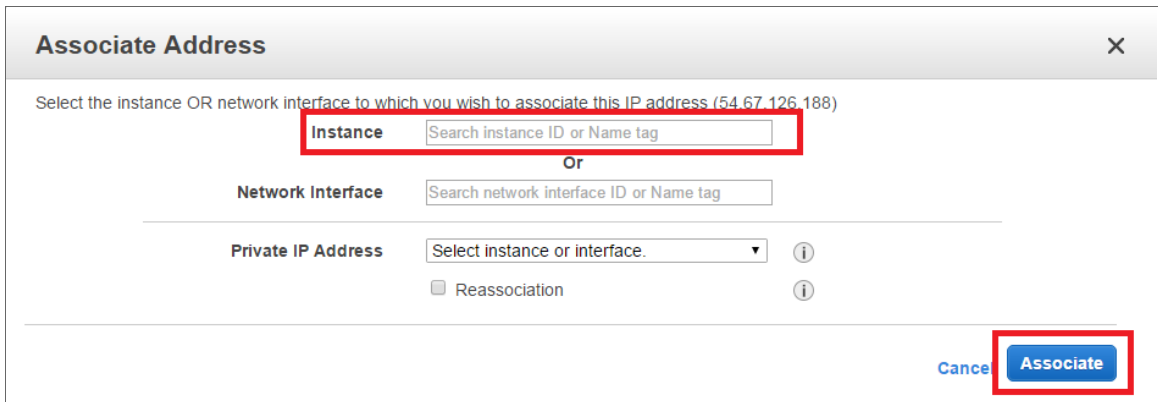

- Select the new ScienceLogic appliance instance in the **Instance** field, then click the **[Associate]** button. The ScienceLogic appliance instance is now associated with the new EIP.

Accessing the Appliance Using SSH

This chapter assumes you have already [received the ScienceLogic AMIs](#) and [created an EC2 instance](#) based on the ScienceLogic AMI.

This chapter assumes that you have access to SSH on the command line (for UNIX users) or have installed PuTTY (for Windows users).

Gathering Information Required for Accessing the Appliance Using SSH

To gather the required information:

1. Go to the [EC2 Dashboard](#):
2. In the left navigation pane, under the **Instances** heading, select **Instances**.

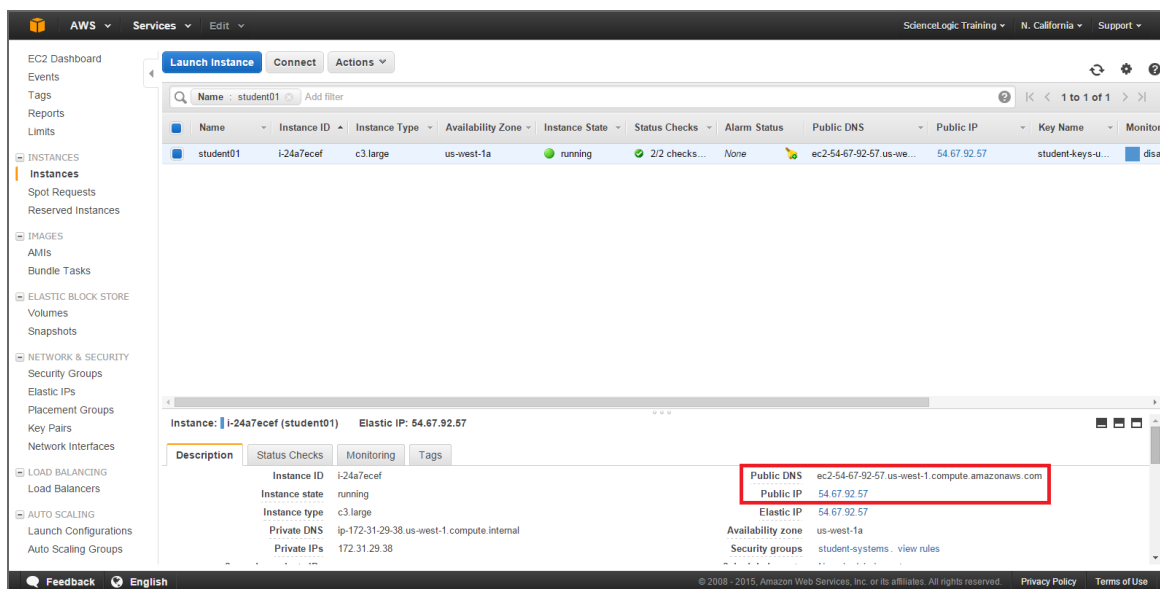

3. Click in the row that contains the ScienceLogic appliance instance.
4. The lower pane contains information about the instance. Write down the **Public DNS** and **Public IP**.
5. If you are using AWS instances to create a distributed ScienceLogic system, perform this step for each AWS instance you want to include in the distributed system.

Configuring SSH

Before you can use SSH with the ScienceLogic appliance instance, you must ensure that SSH can use the .pem file downloaded earlier during the configuration. For details on downloading the .pem file, see the last few steps in the section on [Launching the EC2 Instance](#).

UNIX and LINUX Users

You can connect to your ScienceLogic appliance instance using the SSH command.

NOTE: You should store the .pem file in a secure location. ScienceLogic recommends you store the .pem file in \$HOME/.ssh. ScienceLogic also recommends you change the permissions on the .pem file to allow only read-only access by the owner of the .pem file.

To connect using the .pem file generated by AWS, enter the following at the shell prompt:

```
ssh -i ~/.ssh/my-aws-key.pem em7admin@[hostname or IP address]
```

where:

- `~/.ssh/my-aws-key.pem`. Replace with the name and full path to your .pem file.
- **hostname or IP address**. Replace with the hostname or public-facing IP address of the ScienceLogic appliance instance.

You can also configure your SSH client to automatically select the correct key file when accessing the ScienceLogic appliance instance. For details, see the man page for `ssh_config` for your flavor of UNIX.

Windows Users

You can connect with your ScienceLogic appliance instance using PuTTY and SSH as the em7admin user. However, you must first convert the private key for your instance into a format that PuTTY can use. See the following for detailed instructions on using PuTTY SSH and converting your private key:

<http://docs.aws.amazon.com/AWSEC2/latest/UserGuide/putty.html>

Web Configuration Tool

- For instances of the **Database Server** or **All-In-One Appliance**, see the section on [Licensing the instance in the Web Configuration Tool](#)
- For instances of the **Administration Portal**, see the section on [Configuring the instance in the Web Configuration Tool](#)
- For instances of the **Data Collector and Message Collector**, see the section on [Configuring the instance in the Web Configuration Tool](#)

Rebooting Data Collectors and Message Collectors

After installing a Data Collector or a Message Collector as an AWS instance, you must reboot the instance.

To reboot the AWS instance:

1. Connect to the command-line interface of the appliance as the em7admin user using SSH. See the [Accessing the Appliance Using SSH](#) section for more information.
2. Execute the following command:

```
sudo reboot
```

Deploying a ScienceLogic Virtual Machine in Azure

Introduction

This chapter describes how to deploy a ScienceLogic virtual machine in Azure from a .vhd image file.

To deploy a ScienceLogic appliance in Azure, you need the following components:

- An Azure Resource group
- An Azure storage account that includes at least one blob container
- An Azure Network Security Group (NSG)

The steps to create these components in Azure are described throughout this chapter. This chapter describes:

<i>System Requirements</i>	113
<i>Deploying a ScienceLogic System in Azure</i>	113
<i>Configuring an Azure Storage Account</i>	114
<i>Uploading a .vhd Image File to an Azure Storage Account</i>	116
<i>Creating an Azure Virtual Machine</i>	117
<i>Setting the Virtual Machine Allocation Method to Static</i>	119
<i>Configuring Ports on ScienceLogic Appliances</i>	121
<i>Configuring the Virtual Machine</i>	123
<i>Troubleshooting</i>	126

NOTE: The process described in this chapter is applicable only to Azure Resource Manager; it is not supported in the Azure Classic Portal.

NOTE: If you are configuring a Database, ScienceLogic recommends allocating four times the memory for the Database as compared to the memory for the Data Collectors.

TIP: A single Azure image file can be used to create multiple virtual machines. For example, you can use the same Azure .vhd file for the Database Server to create multiple Database Servers.

System Requirements

For details about requirements and specifications for each ScienceLogic appliance, see the Customer Portal: <https://portal.sciencelogic.com/portal/system-requirements>.

Deploying a ScienceLogic System in Azure

To deploy a distributed ScienceLogic system on Azure instances, create appliances in this order:

1. Database Server
2. Administration Portal (if applicable)
3. Data Collectors
4. Message Collectors (if applicable)

Configuring an Azure Storage Account

To create and configure an Azure storage account:

1. Log in to the Azure Portal, and then click **Resource groups** on the left menu.

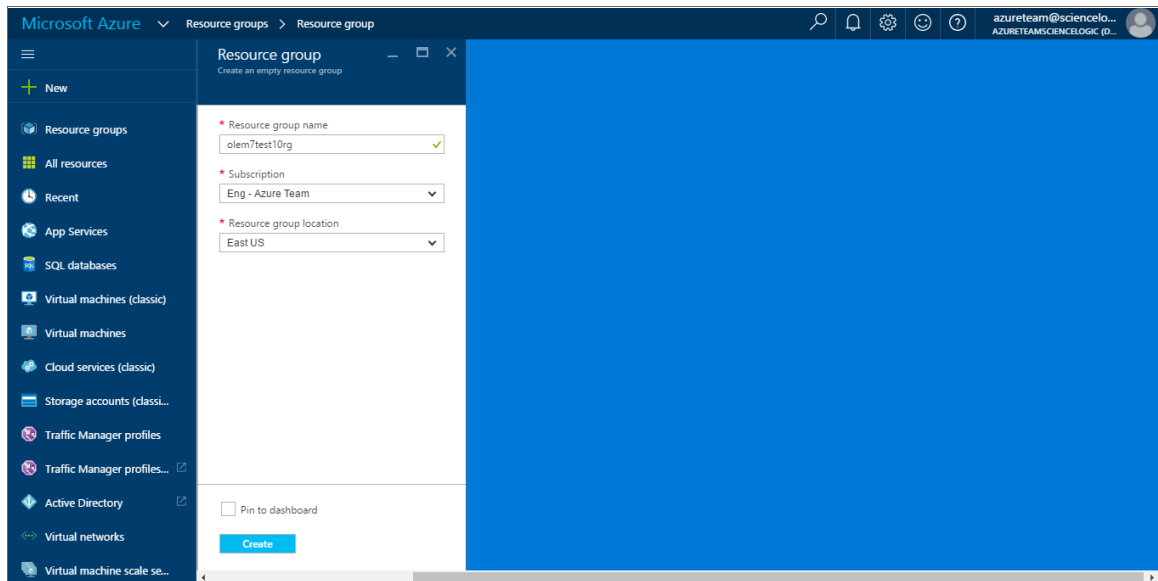

2. Click the **[Add]** button and add information for a new Resource group. Click the **[Create resource group]** button to create the Resource group.
3. After creating the Resource group, click **Storage accounts** on the left menu.

4. Click the **[Add]** button, and then click the **[Create Storage accounts]** button to create a new Storage account. When creating the Storage account, complete the following fields:

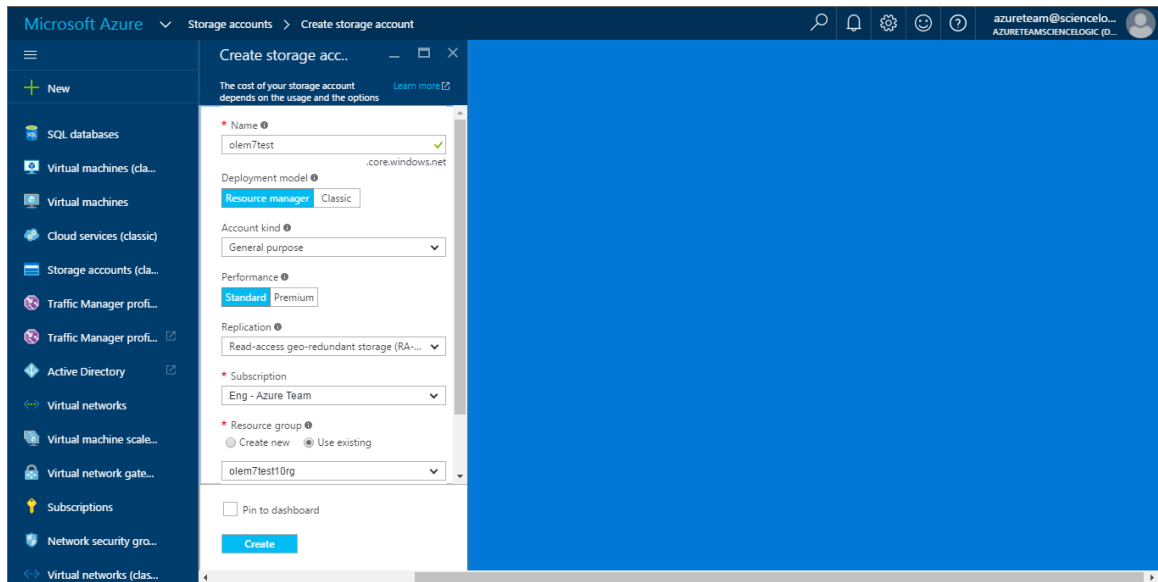

- **Deployment model.** Select *Resource manager*.
 - **Account kind.** Select *General purpose*.
 - **Resource group.** Select *Use existing*, and then select the Resource group you created in step 2.
5. After creating the Storage account, click **Storage accounts** on the left menu, and then select the newly created Storage account.
 6. Under the Services section of the Storage account pane, click **Blobs**. The Blob service blade information appears.

7. In the Blob service pane, click the **Plus** icon to add a new container. Type a name for the container and select *Blob* as the **Access Type**. When you are finished, click the **[Create]** button to create the Blob container.

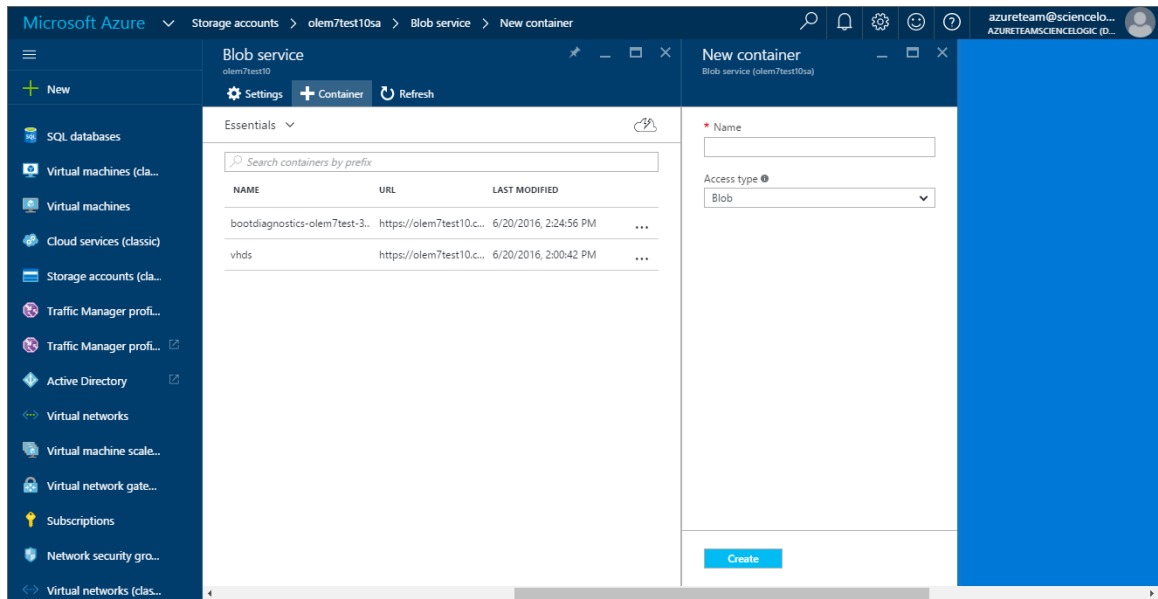

Uploading a .vhd Image File to an Azure Storage Account

After creating the Resource group, Storage account, and Blob container, you must upload the ScienceLogic .vhd image file to the Blob container. To do so, you will need the following information:

- The ScienceLogic .vhd file
- Resource Group name
- Blob container URI
- Local file path to the .vhd file

To download the ScienceLogic .vhd file:

1. Open a browser session and go to:

```
https://portal.sciencelogic.com/portal/images
```

2. Find the platform version that you want to download. Click on its name.
3. At the bottom of the **ScienceLogic Platform Version** page, find a list of .vhd files. Click on the ScienceLogic appliance type for which you want an .vhd.
4. The .vhd file is downloaded to your local computer.
5. Repeat steps 3 and 4 for each ScienceLogic appliance type you want to build.

To upload the ScienceLogic .vhd file to your Blob container, perform the following steps:

1. Open Microsoft Azure PowerShell, and then log in to your Azure account using the cmdlet `Add-AzureRmAccount`:

```
Login-AzureRmAccount
```

2. Ensure that you have a resource group and storage account blob to which you can save the .vhd file. The virtual machine that you create later must be in the same resource group as the storage account.
3. Add your .vhd file to the storage account with the following cmdlet:

```
Add-AzureRmVhd -Destination '<BLOB_URI>' -LocalFilePath '<VHD_LOCAL_FILE_PATH>' -ResourceGroupName '<RESOURCE_GROUP>'
```

TIP: When entering the Blob URI, you must include the .vhd file name. For example:
"https://azuretest.blob.core.windows.net/vhds/em7inazure.vhd".

4. Repeat step 3 for each .vhd file.

Creating an Azure Virtual Machine

NOTE: The following steps require that you have an ARM resource group and storage account with the .vhd file uploaded.

To create an Azure virtual machine:

1. In a web browser, open <https://portal.azure.com/#create/Microsoft.Template/uri/https%3A%2F%2Fraw.githubusercontent.com%2Fazure%2Fazure-quickstart-templates%2Fmaster%2F201-vm-specialized-vhd-new-or-existing-vnet%2Fazuredeploy.json> and click the **[Deploy to Azure]** button.

- The Azure Portal launches and the **TemplateParameters** pane appears. Complete the following information:

Microsoft Azure Create a VM from a specialized VHD disk

Azure quickstart template

TEMPLATE

201-vm-specialized-vhd
5 resources

Edit template Learn more

BASICS

* Subscription AZdevelopment

* Resource group Create new Use existing
em784collector

* Location East US

SETTINGS

* Os Disk Vhd Uri ✓

* Os Type

Vm Size

* Vm Name ✓

TERMS AND CONDITIONS

template. Prices and associated legal terms for any Marketplace offerings can be found in the [Azure Marketplace](#); both are subject to change at any time prior to deployment.

Neither subscription credits nor monetary commitment funds may be used to purchase non-Microsoft offerings. These purchases are billed separately.

Pin to dashboard

Purchase

- **Subscription**. Select the Azure subscription to use for the virtual machine deployment.
 - **Resource Group**. Select *Use existing*, and then select the Resource group that was created in step 2 of the section [Configuring an Azure Storage Account](#).
 - **Location**. Use the default resource group location.
 - **Os Disk Vhd Uri**. Type the URI of the .vhd file that you uploaded in step 3 of the section [Uploading a .vhd File to an Azure Storage Account](#).
 - **Os Type**. Select *Linux*.
 - **Vm Size**. Specify the size of your virtual machine. For more sizing information, see the [ScienceLogic System Requirements portal page](#).
 - **Vm Name**. Type a custom name for your virtual machine.
- Review the legal terms in the Terms and Conditions section, and then click **[Purchase]**.
 - Click **[Create]** to deploy the virtual machine.
 - Repeat these steps for each ScienceLogic appliance you want to build.

To verify that the virtual machine deployment is successful, navigate to the Virtual Machines pane and search for the custom virtual machine name.

Setting the Virtual Machine Allocation Method to Static

To ensure the IP address for the virtual machine remains the same after reboot, you must set the allocation method to *static*. To do so:

1. In the Azure Portal, navigate to the Virtual machine pane and verify that the virtual machine has a public IP address and a virtual network/subnet set.

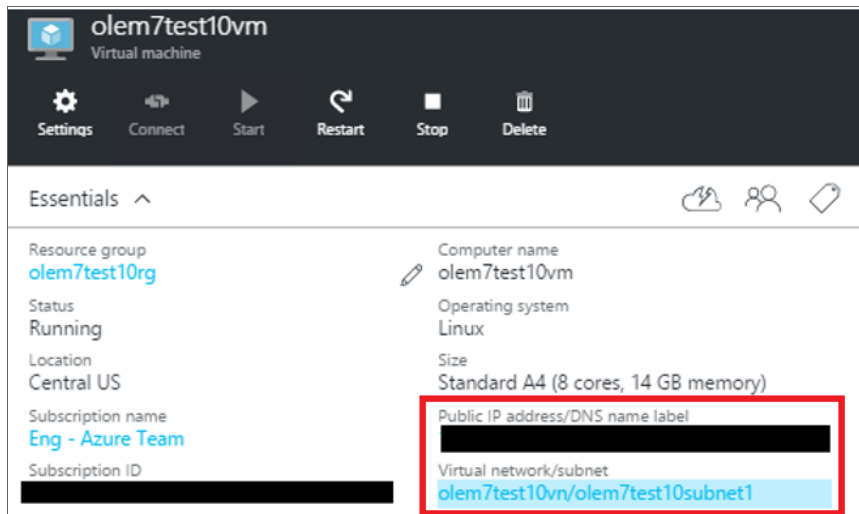

- Click the name of the Virtual network/subnet. The Virtual network pane appears.

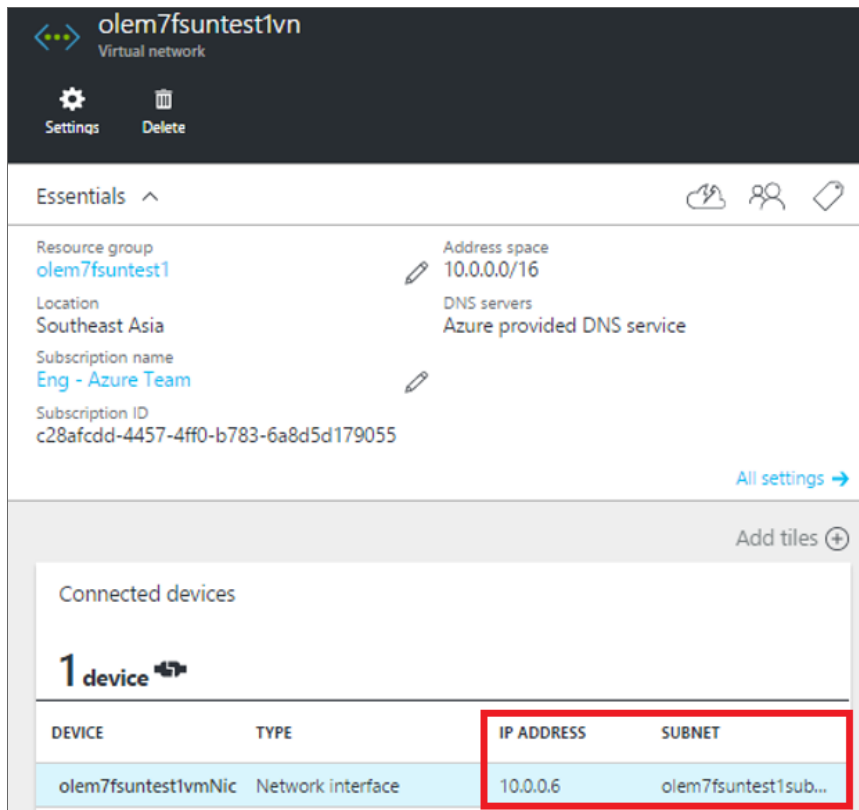

- In the "Connected devices" section of the Virtual network pane, click the Network interface. The Network interface pane appears.
- Click the Public IP address value, and then click the **[Dissociate]** button.

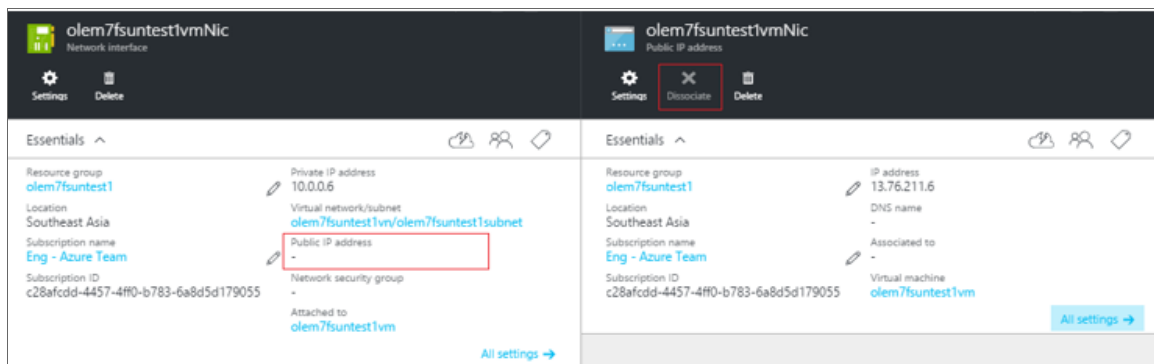

- In the Network interface pane, click on **Settings > IP addresses**. Then, do one of the following:
 - If you **are not** using a VPN, complete steps 6 through 9. Ignore step 10.
 - If you **are** using a VPN, skip ahead to step 10.

6. If you **are not** using a VPN, then in the IP addresses pane, select *Enabled* in the **Public IP address** field and then click on the **IP address** field.
7. Click the **[Create new]** button.
8. In the Create public IP address pane, type a name for your IP address in the **Name** field and select *Static* in the **Assignment** field.
9. Click **[OK]** and then click **[Save]**.
10. If you **are** using a VPN, then in the IP addresses pane, select *Disabled* in the **Public IP address** field and then select a **Subnet**. You can use the default values for all other fields.

Configuring Ports on ScienceLogic Appliances

You must next create a Network security group that will specify the ports required for communication between the ScienceLogic appliances and that will specify the ports required for communication between the ScienceLogic appliances and the monitored devices in your network.

To configure the ports for communication:

1. In the Azure Portal, navigate to the Network security groups pane, and then click the **[Add]** button. The Create network security group pane appears.

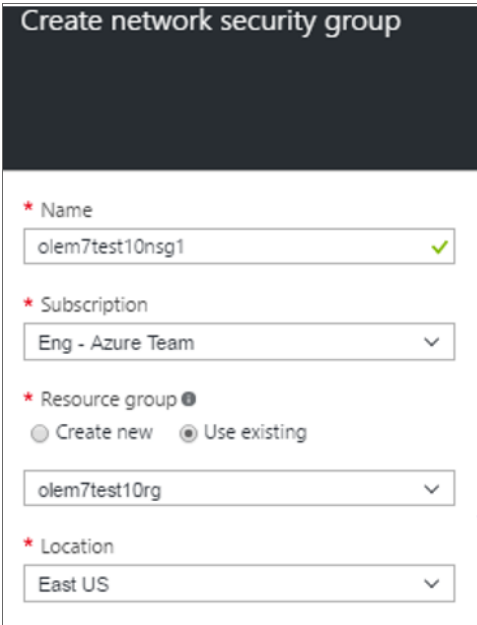

The screenshot shows the 'Create network security group' pane in the Azure Portal. The pane is titled 'Create network security group' and contains several fields:

- Name:** olem7test10nsg1 (with a green checkmark)
- Subscription:** Eng - Azure Team
- Resource group:** olem7test10rg (with radio buttons for 'Create new' and 'Use existing', where 'Use existing' is selected)
- Location:** East US

2. Type the information for the Network security group (name, subscription, resource group, and location), then click **[Create]**.
3. In the Network security groups pane, click the newly created Network security group, and then click the **[Settings]** button.
4. In the Settings pane, click **Inbound security rules**.

5. In the Inbound security rules pane, click the **[Add]** button. The Add inbound security rule pane appears.

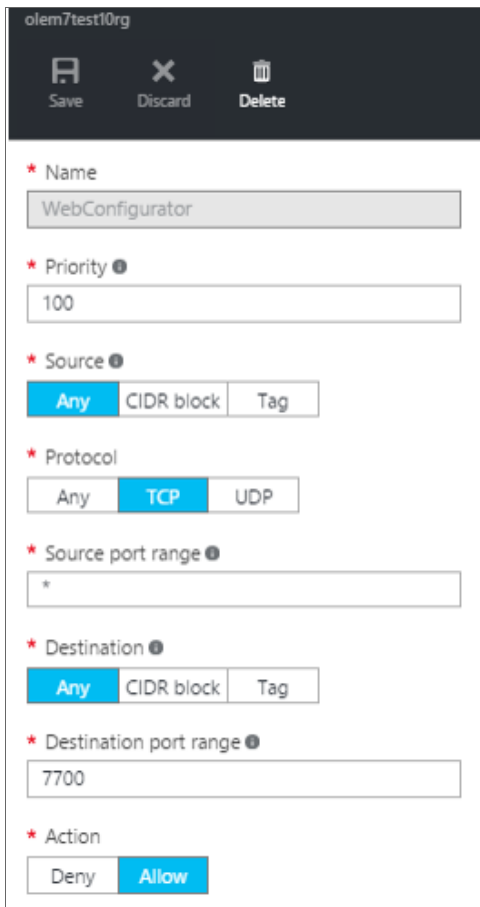

olem7test10rg

Save Discard Delete

* Name
WebConfigurator

* Priority ⓘ
100

* Source ⓘ
Any CIDR block Tag

* Protocol
Any TCP UDP

* Source port range ⓘ
*

* Destination ⓘ
Any CIDR block Tag

* Destination port range ⓘ
7700

* Action
Deny Allow

6. Use the tables below to create security rules.
7. Repeat steps 5 and 6 to create an inbound security rule for each of the ports listed in the table below.
8. After creating all of the inbound security rules, navigate to the Virtual machine pane and click the **[Settings]** button.
9. In the Settings pane, click **Network interfaces** and then click on the name of the Network interface.
10. In the Network interface pane, click the **[Settings]** button and then click **Network security group**.
11. Select the newly created network security group to associate it with the Network interface.
12. Perform steps #9 -#11 for each network interface in your ScienceLogic system.

NOTE: ScienceLogic recommends that you limit the Source port range for security reasons.

Type	Protocol	Port	Description
SSH	TCP	22	SSH. This is necessary to start the installation wizard.
SMTP	TCP	25	Necessary to receive inbound email for tickets, events, and email round-trip monitoring.
HTTP	TCP	80	HTTP from browser session or user workstation.
Custom TCP Rule	TCP	123	NTP. Communication between the All-In-One Appliance and configured NTP server.
Custom UDP Rule	UDP	161	SNMP Agent. Allows SNMP information about the ScienceLogic appliance to be collected by the ScienceLogic platform.
Custom UDP Rule	UDP	162	SNMP Traps. Necessary to receive SNMP traps from managed devices.
HTTPS	TCP	443	HTTPS from browser session or user workstation.
Custom UDP Rule	UDP	514	Syslog messages. Necessary to receive syslog messages from managed devices.
Custom TCP Rule	TCP	7700	ScienceLogic Web Configurator. Configuration Utility from browser session or user workstation. This is necessary to license the appliance.
Custom TCP Rule	TCP	7706	MySQL. Communication from Administration Portal.
Custom TCP Rule	TCP	7707	Data Pull. Allows the Database Server to retrieve data from the ScienceLogic appliance.
Custom TCP Rule	TCP	8008	Administrative Web Interface (PHPMyAdmin) from browser session on user workstation.

Configuring the Virtual Machine

To configure each virtual machine, perform the following steps:

1. Use SSH to access the virtual machine using its public IP address and the username and password that were defined in step 2 of the section [Creating an Azure Virtual Machine](#).
2. Run `em7_install.sh` in a special operational mode:

```
sudo /opt/em7/share/scripts/em7_install.sh --instance-init-only
```
3. On the Administration Portal (and the Database Server only if you are using the Administration Portal on the Database Server), run the following command to start the web server:

```
sudo service nginx start
```

- Using vi or another text editor, edit the /etc/silo.conf file



```
sudo vi /etc/silo.conf
```

- In the LOCAL section, set ipaddress to the the Azure virtual machine's public IP address. If a VPN is used, however, set the ipaddress field to the VM's private IP address. For example, see the bolded text below:

```
[LOCAL]
rootdir = /opt/em7
vardir = /var/lib/em7
logdir = /var/log/em7
rundir = /run/em7
ipaddress = 172.16.10.10
dbdir = /data/db
dbserver = 172.16.10.11
dbport = 7706
dbuser = root
dbpasswd = em7admin
portcheck = /usr/bin/nmap
model_type = 1
eventmanager = internal,email,syslog,trap,dynamic
```

6. Perform the required steps in the Web Configuration Tool.
 - For instances of the **Database Server** or **All-In-One Appliance**:
 - [Licensing the instance in the Web Configuration Tool](#)

NOTE: Upon installation, SL1 appliances are automatically licensed for 30 days. During these 30 days, you can perform the steps to obtain a permanent license from ScienceLogic.

- For instances of the **Administration Portal**:
 - [Configuring the instance in the Web Configuration Tool](#)
 - When prompted for the IP address of the Database Server,
 - If you are not using a VPN, enter the public IP address of the Database Server.
 - If you are using a VPN, use the private IP address of the Database Server.
 - For instances of the **Data Collector and Message Collector**:
 - [Configuring the instance in the Web Configuration Tool](#)
 - When prompted for the IP address of the Database Server,
 - If you are not using a VPN, enter the public IP address of the Database Server.
 - If you are using a VPN, use the private IP address of the Database Server. .
7. Open a browser session to SL1 (to the Administration Portal). Go to the **Appliance Manager** page (System > Settings > Appliances).
 8. If you are using an All-In-One Appliance, you will see two entries for the All-In-One Appliance.
 - Select the bomb icon for the All-In-One Appliance for which the bomb icon () is enabled.
 - In the remaining entry, select the wrench icon (). In the top pane, enter the IP Address specified in Azure for the All-In-One Appliance. Click **[Save]**.
 9. If you are using a distributed system, you will see two entries for the Database Server.
 - Select the bomb icon for the Database Server for which the bomb icon () is enabled.

Troubleshooting

If the Data Collector continuously displays a message saying the collector is working when running a Dynamic Application, **DO NOT** restart the Azure virtual machine, as doing so could cause you to lose SSH access to the machine.

Instead, do the following:

1. Using the command line interface, verify whether you can run the Dynamic Application in debug mode by typing the following command:

```
sudo /usr/local/silo/proc/dynamic_single.py <did> <app_id>
```

2. Restart the data pull processes (em7_hfpulld, em7_lfpulld, em7_mfpulld) by typing the following command:

```
sudo service <service_name> restart
```

© 2003 - 2018, ScienceLogic, Inc.

All rights reserved.

LIMITATION OF LIABILITY AND GENERAL DISCLAIMER

ALL INFORMATION AVAILABLE IN THIS GUIDE IS PROVIDED "AS IS," WITHOUT WARRANTY OF ANY KIND, EITHER EXPRESS OR IMPLIED. SCIENCELOGIC™ AND ITS SUPPLIERS DISCLAIM ALL WARRANTIES, EXPRESS OR IMPLIED, INCLUDING, BUT NOT LIMITED TO, THE IMPLIED WARRANTIES OF MERCHANTABILITY, FITNESS FOR A PARTICULAR PURPOSE OR NON-INFRINGEMENT.

Although ScienceLogic™ has attempted to provide accurate information on this Site, information on this Site may contain inadvertent technical inaccuracies or typographical errors, and ScienceLogic™ assumes no responsibility for the accuracy of the information. Information may be changed or updated without notice. ScienceLogic™ may also make improvements and / or changes in the products or services described in this Site at any time without notice.

Copyrights and Trademarks

ScienceLogic, the ScienceLogic logo, and EM7 are trademarks of ScienceLogic, Inc. in the United States, other countries, or both.

Below is a list of trademarks and service marks that should be credited to ScienceLogic, Inc. The ® and ™ symbols reflect the trademark registration status in the U.S. Patent and Trademark Office and may not be appropriate for materials to be distributed outside the United States.

- ScienceLogic™
- EM7™ and em7™
- Simplify IT™
- Dynamic Application™
- Relational Infrastructure Management™

The absence of a product or service name, slogan or logo from this list does not constitute a waiver of ScienceLogic's trademark or other intellectual property rights concerning that name, slogan, or logo.

Please note that laws concerning use of trademarks or product names vary by country. Always consult a local attorney for additional guidance.

Other

If any provision of this agreement shall be unlawful, void, or for any reason unenforceable, then that provision shall be deemed severable from this agreement and shall not affect the validity and enforceability of any remaining provisions. This is the entire agreement between the parties relating to the matters contained herein.

In the U.S. and other jurisdictions, trademark owners have a duty to police the use of their marks. Therefore, if you become aware of any improper use of ScienceLogic Trademarks, including infringement or counterfeiting by third parties, report them to Science Logic's legal department immediately. Report as much detail as possible about the misuse, including the name of the party, contact information, and copies or photographs of the potential misuse to: legal@sciencelogic.com



800-SCI-LOGIC (1-800-724-5644)

International: +1-703-354-1010